



NOVÉ

RAD **LINEO QUIET**

Nízkohlučné potrubné ventilátory



RAD **LINEO QUIET**

Nízkohlučné potrubné ventilátory

Rad **LINEO QUIET** charakterizuje použitie špeciálne tvarovaných komponentov a **hlukovo-izolačného materiálu**, ktorý je plne integrovaný do opláštenia a optimalizovaný na minimalizáciu emisií hluku ventilátora do okolia.

**VYSOKÁ ÚROVEŇ VÝKONU,
NÍZKA ÚROVEŇ HLUKU.**



pretože spotreba
musí byť....

MINIMÁLNA

Vysokoučinný motor, prepracovaný profil vrtule, vylepšený usmerňovač prietoku a korektor prietoku ogiválneho tvaru pracujú v dokonalej synergii, čím optimalizujú prúdenie vzduchu vo ventilátore, redukujú prítomnosť turbulencií, maximalizujú výkon, zvyšujú účinnosť a dokonale minimalizujú hlučnosť.

pretože ticho
musí byť....

ZABUDOVANÉ

VRTUĽA

Navrhnutá pre dosiahnutie vyššej účinnosti a splnenie ErP

VRCHNÉ PROTIHLUKOVÉ OPLÁŠTENIE

Ľahko odoberateľné pre údržbu,
bez rizika poškodenia
hlukovo-izolačného materiálu

NASÁVACÍ OTVOR

Prípojenie na potrubie

DIVERGENTNÝ ELEMENT

Slúži na zvýšenie výkonových
parametrov vrtule

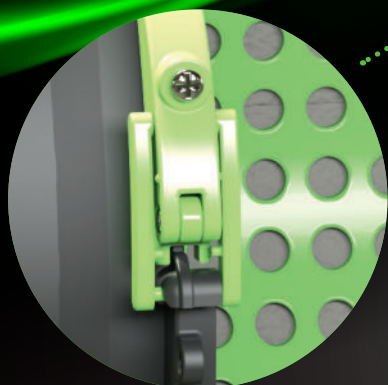

NOVÉ

RAD LINEO QUIET

Nízkohlučné potrubné ventilátory



EL. KRABICA

Pripojenie el. napájania
/ umiestnenie riadiacej
dosky

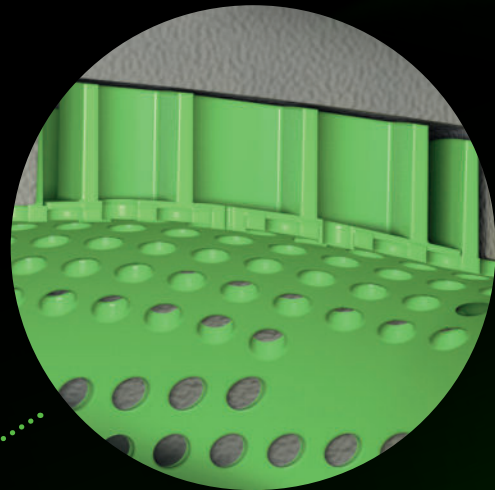

ÚTLM HLUKU NA BÁZE HELMHOLTZOVHO REZONÁTORA

Pasívne tlmíče hluku na pohltenie zvukových vln
v konkrétnych frekvenciách

VÝFUKOVÝ OTVOR

Pripojenie na potrubie

KOREKTOR PRIETOKU

Vďaka špecificky navrhnutému
ogiválnemu tvaru, koriguje prietok
za vrtuľou a usmerňovačom
a tak minimalizuje straty
energie vírením

SPODNÉ PROTIHLUKOVÉ OPLÁŠTENIE

Lahko odoberateľné pre údržbu,
bez rizika poškodenia
hlukovo-izolačného materiálu

USMERŇOVAČ PRIETOKU

Navrhovaný spolu s vrtuľou,
na usmernenie prietoku
a minimalizáciu turbulencií za vrtuľou

RAD LINEO QUIET ES

s EC motorom

Produkty radu **LINEO QUIET ES** sa líšia od radu **LINEO QUIET** použitím vysokoúčinných elektronicky riadených 2-otáčkových EC motorov (s nízkou spotrebou). Jednotlivé otáčky je možné nastaviť pri inštalácii. Alternatívne môžu pracovať ako 1-otáčkové, s riadením výkonu cez signál 0-10V.



RAD LINEO QUIET

s AC motorom

Produkty radu **LINEO QUIET** sú v závislosti od veľkosti vybavené 2 alebo 3-otáčkovými AC motormi.



NOVÉ

RAD LINEO QUIET
Nízkohlučné potrubné ventilátory



pretože životné prostredie
musí byť....

CHRÁNENÉ



TECHNICKÉ A VÝKONOVÉ ÚDAJE - LINEO QUIET ES

Modely	Kód	El. napájanie 1f/50Hz (V)	El. príkon 4V/6V/8V/10V (W)	El. prúd 4V/6V/8V/10V (A)	Otáčky 4V/6V/8V/10V (ot/min)	Vzduch. výkon 4V/6V/8V/10V (m ³ /h)	Výtlak 4V/6V/8V/10V (Pa)	Krytie*	Max. teplota (°C)	Hmotnosť (kg)
LINEO 100 QUIET ES	17170	220-240	6.2	0.09	1140	135	34.3	IP45	60	3.8
			8.3	0.12	1450	175	56.9			
			14.7	0.18	2050	250	111.8			
			23	0.26	2510	300	243.2			
LINEO 125 QUIET ES	17171	220-240	6.6	0.10	1080	180	32.4	IP45	60	3.6
			8.8	0.12	1340	225	54.9			
			16	0.18	1865	320	107.9			
			24	0.26	2210	380	232.4			
LINEO 150 QUIET ES	17172	220-240	7.7	0.11	1015	250	45.1	IP45	60	5.4
			10.6	0.14	1240	305	73.6			
			20	0.24	1700	430	107.9			
			31	0.34	2030	515	237.3			
LINEO 160 QUIET ES	17173	220-240	7.7	0.11	1010	250	44.1	IP45	60	5.2
			10.6	0.14	1245	315	73.6			
			19.7	0.23	1685	435	141.2			
			31	0.34	2035	525	234.4			
LINEO 200 QUIET ES	17174	220-240	15.2	0.18	1380	570	84.3	IP45	50	8.6
			25.3	0.27	1705	720	136.3			
			52.4	0.52	2245	945	224.6			
			88	0.78	2700	1145	329.5			
LINEO 250 QUIET ES	17175	220-240	20	0.19	1365	750	99.1	IP45	50	13.4
			35	0.28	1680	940	153			
			75	0.60	2250	1250	260.9			
			125	0.97	2680	1485	367.8			
LINEO 315 QUIET ES	17176	220-240	42	0.31	1260	1400	126.5	IP45	50	28.3
			72	0.51	1560	1730	191.2			
			155	1.10	2070	2300	331.5			
			220	1.52	2350	2630	379.5			

údaje uvedené pre 4V/6V/8V/10V (napätie z regulátora)

* krytie platné pre ventilátory napojené na potrubie z oboch strán

HLUČNOSŤ - LINEO QUIET ES

Modely	Kód	NASÁVANIE				VÝFUK				DO OKOLIA			
		4V	6V	8V	10V	4V	6V	8V	10V	4V	6V	8V	10V
LINEO 100 QUIET ES	17170	64.8	72.4	77.5	79.1	64.5	73.2	75.6	79	38.1	46.2	46.5	47.9
LINEO 125 QUIET ES	17171	63.7	71	75.8	78.3	64.3	73.5	74.7	79.4	42.3	48.5	51	51.7
LINEO 150 QUIET ES	17172	65.5	72.1	75	76.9	66	72.8	75.6	76.7	40.7	45.8	49.6	50.8
LINEO 160 QUIET ES	17173	65.5	72.1	75	76.9	66	72.8	75.6	76.7	40.7	45.8	49.6	50.8
LINEO 200 QUIET ES	17174	74.8	80	82.6	84.7	72.4	77.6	80.5	83.6	49.9	54.4	56.9	59.1
LINEO 250 QUIET ES	17175	71.4	76.7	83.7	88.1	70.7	76.1	83	87.2	44.4	49.1	55.9	60
LINEO 315 QUIET ES	17176	82.6	85.7	88.3	89.1	73.3	80.6	82.2	84.5	55.9	62.3	64.7	65.3

Modely	Kód	NASÁVANIE				VÝFUK				DO OKOLIA			
		4V	6V	8V	10V	4V	6V	8V	10V	4V	6V	8V	10V
LINEO 100 QUIET ES	17170	47.3	54.9	59.9	61.5	47	55.7	25.9	47	17.6	25.6	25.9	27.4
LINEO 125 QUIET ES	17171	46.1	53.4	58.3	60.8	46.8	56	57.2	61.9	21.8	28	30.4	31.3
LINEO 150 QUIET ES	17172	48	54.6	57.4	59.4	49	55.3	58.1	59.1	20.2	25.3	29.1	30.2
LINEO 160 QUIET ES	17173	48	54.6	57.4	59.4	49	55.3	58.1	59.1	20.2	25.3	29.1	30.2
LINEO 200 QUIET ES	17174	57.3	62.4	65.1	67.1	54.8	60.1	63	66.1	29.4	33.9	36.4	38.6
LINEO 250 QUIET ES	17175	53.9	59.2	66.1	70.5	52	58.6	65.5	69.7	23.8	28.6	35.4	39.5
LINEO 315 QUIET ES	17176	65.1	68.2	70.8	71.6	55.8	63.1	64.6	67	35.4	41.8	44.1	44.8

** kalkulované vo voľnom priestore vo vzdialenosti 3m

ROZMERY - LINEO QUIET ES

Modely	Kód	A	B	C	Ø D	E	F	G	H	L	Ø M	N	VERZIA
LINEO 100 QUIET ES	17170	210	294.6	639	97	130	235	135	120	67.5	5.5	320	A
LINEO 125 QUIET ES	17171	210	294.6	504.5	122	130	235	135	120	67.5	5.5	320	A
LINEO 150 QUIET ES	17172	232	320.6	685	147	145	261.5	170	132	85	5.5	360	A
LINEO 160 QUIET ES	17173	232	320.6	570	156.5	145	261.5	170	135	85	5.5	360	A
LINEO 200 QUIET ES	17174	322.5	417.6	625.5	194.5	195	363.5	190	120	155	5.5	510	B
LINEO 250 QUIET ES	17175	318	411.9	751.5	243	189.5	363.5	200	70	170	6.5	604.5	B
LINEO 315 QUIET ES	17176	415.5	557.8	940	307	234	441	309	110	255	8.5	780	C

VERZIA A

LINEO 100 QUIET ES - LINEO 125 QUIET ES - LINEO 150 QUIET ES - LINEO 160 QUIET ES

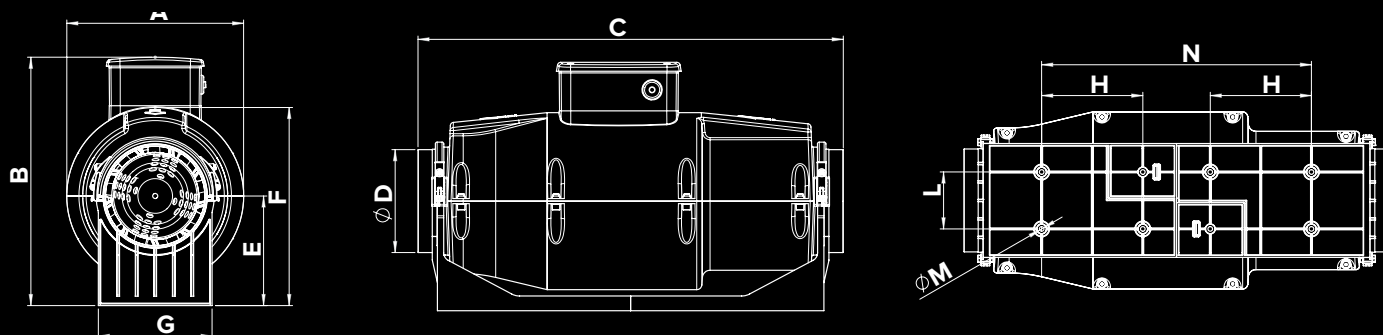

VERZIA B

LINEO 200 QUIET ES - LINEO 250 QUIET ES

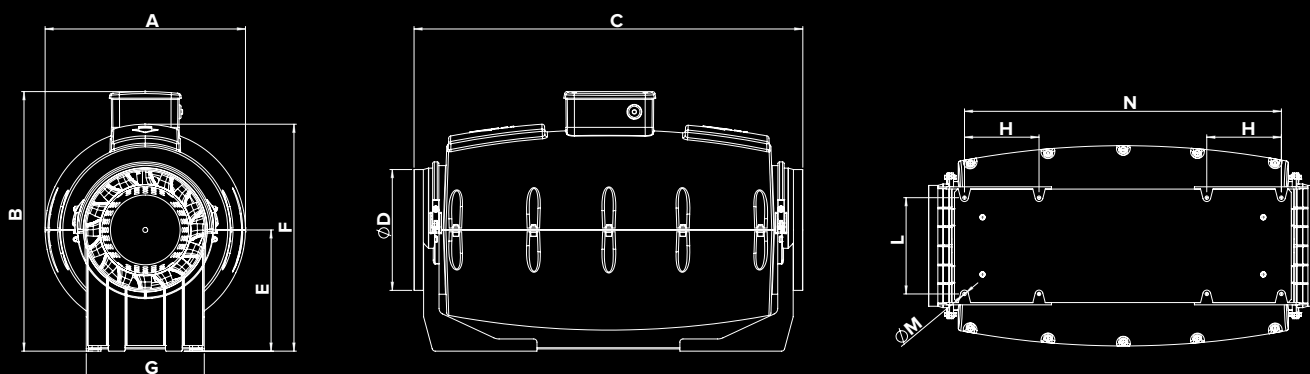

VERZIA C

LINEO 315 QUIET ES

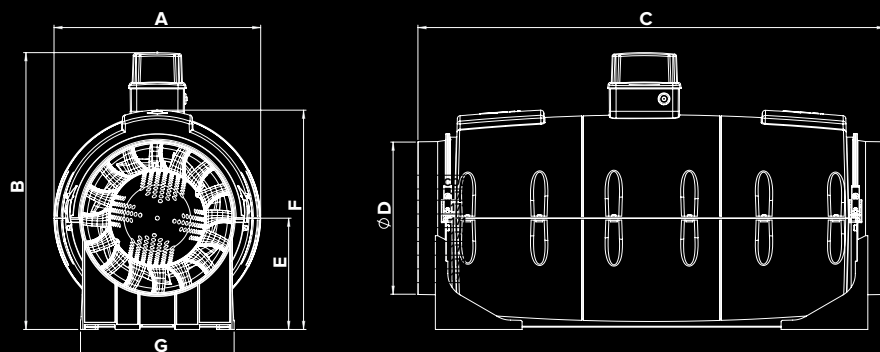

TLAKOVO-VÝKONOVÉ KRIVKY - LINEO QUIET ES

LINEO 100 QUIET ES

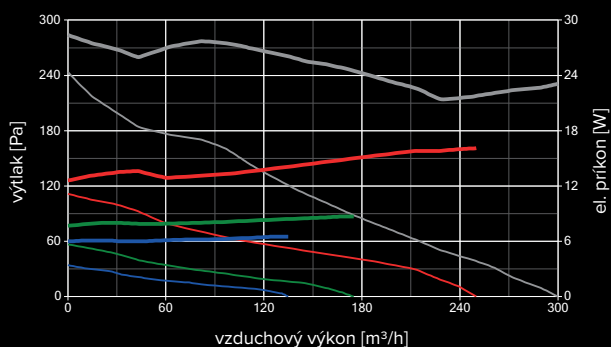

LINEO 125 QUIET ES

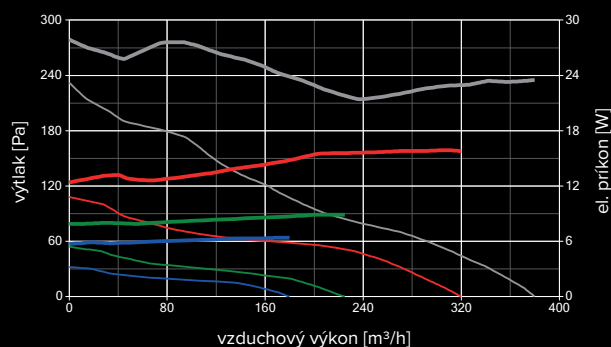

LINEO 150 QUIET ES

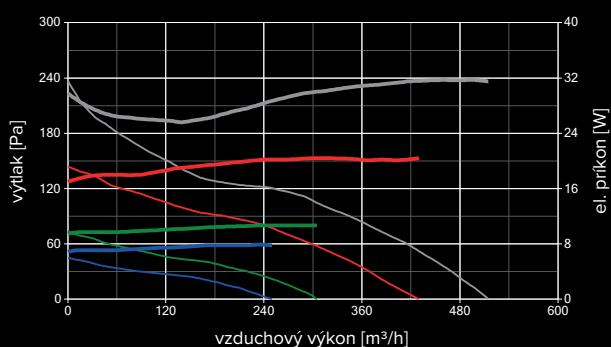

LINEO 160 QUIET ES

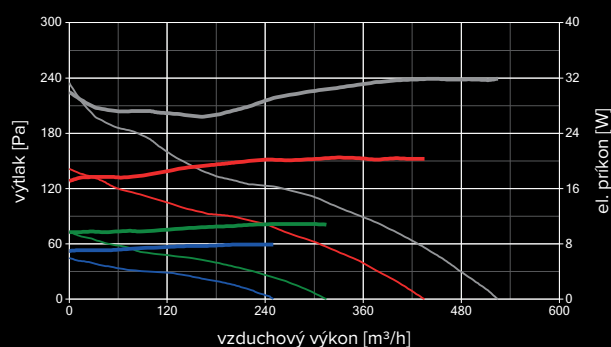

LINEO 200 QUIET ES

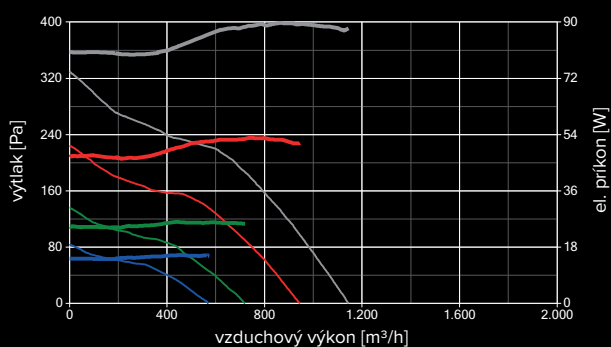

LINEO 250 QUIET ES

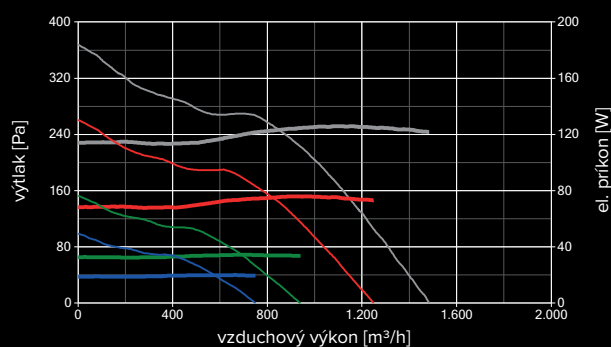

LINEO 315 QUIET ES

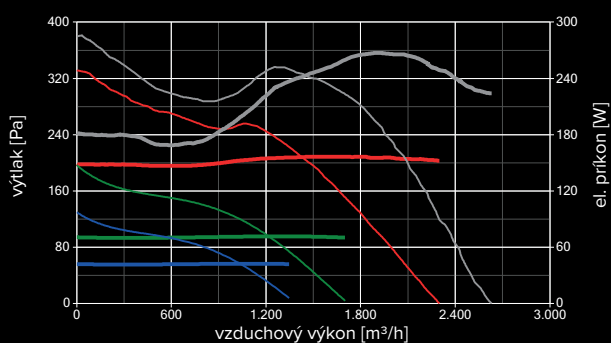

EL. PRÍKON	VÝKON
— 10V	— 10V
— 8V	— 8V
— 6V	— 6V
— 4V	— 4V

REGULÁTORY - LINEO QUIET ES

MODELY	POPIS	KÓD	KOMPATIBILITA
	POT-IT - POTENCIOMETER 0-10V A PREPÍNAČ ZAP/VYP (VYŽADUJE KRABIČKU UNI 503)	12826	17170 - 17171 - 17172 - 17173 - 17174 17175 - 17176
	POT - POTENCIOMETER 0-10V (VYŽADUJE KRABIČKU DIN)	12828	17170 - 17171 - 17172 - 17173 - 17174 17175 - 17176
	DUO - VYPÍNAČ A PREPÍNAČ OTÁČOK	22914	VŠETKY MODELY
	C TEMP - SNÍMAČ TEPLoty	12992	VŠETKY MODELY
	C SMOKE - SNÍMAČ PACHOV	12993	VŠETKY MODELY
	C HCS - SNÍMAČ VLHKOSTI	12994	VŠETKY MODELY
	C PIR - SNÍMAČ POHYBU	12998	VŠETKY MODELY
	C TIMER - ČASOVAČ	12999	VŠETKY MODELY

TECHNICKÉ A VÝKONOVÉ ÚDAJE - LINEO QUIET

Modely	Kód	El. napájanie 1f/50Hz (V)	El. príkon min/str/ max (W)	El. prúd min/str/ max (A)	Otáčky min/str/ max (ot/min)	Vzduch. výkon min/str/max (m ³ /h)	Výtlak min/str/ max (Pa)	Krytie*	Max. teplota (°C)	Hmotnosť (kg)
LINEO 100 QUIET	17160	220-240	11	0.09	1455	150	88.3	IP45	45	3,8
LINEO 100 T QUIET	17190		24	0.11	1880	200	112.8			
LINEO 125 QUIET	17161	220-240	11	0.09	1125	190	78.5	IP45	45	3,6
LINEO 125 T QUIET	17191		24	0.11	1475	250	98.1			
LINEO 150 QUIET	17162	220-240	24	0.14	1040	255	103	IP45	55	5,4
LINEO 150 T QUIET	17192		37	0.17	1430	350	152			
LINEO 160 QUIET	17163	220-240	24	0.14	1040	255	103	IP45	55	5,2
LINEO 160 T QUIET	17193		37	0.17	1430	350	152			
LINEO 200 QUIET	17164	220-240	50	0.34	1880	805	202	IPX5	50	8,6
LINEO 200 T QUIET	17194		80	0.42	2380	1045	257.9			
LINEO 250 QUIET	17165	220-240	95	0.42	1640	960	198.1	IPX5	50	13,4
			125	0.55	2320	1340	297.2			
LINEO 315 QUIET	17166	220-240	150	0.65	2750	1550	339.3	IPX5	50	28,3
			215	0.95	1930	2070	300.1			
LINEO 315 QUIET	17166	220-240	270	1.15	2360	2530	424.6	IPX5	50	28,3
			360	1.55	2705	2890	525.7			

* krytie platné pre ventilátory napojené na potrubie z oboch strán

HLUČNOSŤ - LINEO QUIET

Modely	Kód	NASÁVANIE			AKUSTICKÝ VÝKON Lw dB (A)			DO OKOLIA		
		min	str.	max	min	str.	max	min	str.	max
LINEO 100 QUIET	17160	62.2	70.5	74.6	62.3	68.7	74.4	36.2	41.8	46.6
LINEO 100 T QUIET	17190									
LINEO 125 QUIET	17161	60.1	64.2	70.4	60.5	64.2	70.9	36.2	41.8	45.5
LINEO 125 T QUIET	17191									
LINEO 150 QUIET	17162	60.3	68.2	77.3	62.1	67.7	76	38.2	43.4	51.2
LINEO 150 T QUIET	17192									
LINEO 160 QUIET	17163	60.3	68.2	77.3	62.1	67.7	76	38.2	43.4	51.2
LINEO 160 T QUIET	17193									
LINEO 200 QUIET	17164	76.9	83.3	86.4	75.1	81.5	85	51.6	57.4	60.7
LINEO 200 T QUIET	17194									
LINEO 250 QUIET	17165	76.3	83.6	85.1	75	83.4	87.4	49.5	57	60.7
LINEO 315 QUIET	17166	82.8	87	91.7	82.8	87	89.8	58.8	62.9	65.9

Modely	Kód	NASÁVANIE			AKUSTICKÝ TLAK LP dB(A)**			DO OKOLIA		
		min	str.	max	min	str.	max	min	str.	max
LINEO 100 QUIET	17160	44.6	52.9	57.1	44.8	51.2	56.9	15.7	21.3	26.1
LINEO 100 T QUIET	17190									
LINEO 125 QUIET	17161	42.6	46.7	52.9	43	46.6	53.4	15.6	21.1	25
LINEO 125 T QUIET	17191									
LINEO 150 QUIET	17162	42.8	50.7	59.7	44.5	50.1	58.5	17.6	22.9	30.7
LINEO 150 T QUIET	17192									
LINEO 160 QUIET	17163	42.8	50.7	59.7	44.5	50.1	58.5	17.6	22.9	30.7
LINEO 160 T QUIET	17193									
LINEO 200 QUIET	17164	59.3	65.8	68.8	57.6	64	67.5	31	36.9	40.2
LINEO 200 T QUIET	17194									
LINEO 250 QUIET	17165	58.8	67.6	71.5	57.5	65.9	69.9	29	36.5	40.1
LINEO 315 QUIET	17166	66.8	71	74.2	65.3	69.5	72.3	38.3	42.4	45.4

** kalkulované vo voľnom priestore vo vzdialenosti 3m

ROZMERY - LINEO QUIET

Modely	Kód	A	B	C	Ø D	E	F	G	H	L	Ø M	N	VERZIA
LINEO 100 QUIET	17160												
LINEO 100 T QUIET	17190	210	294.5	639	97	130	235	135	120	67.5	5.5	320	A
LINEO 125 QUIET	17161												
LINEO 125 T QUIET	17191	210	294.6	504.5	122	130	235	135	120	67.5	5.5	320	A
LINEO 150 QUIET	17162												
LINEO 150 T QUIET	17192	232	320.5	685	147	145	261.5	170	132	85	5.5	360	A
LINEO 160 QUIET	17163												
LINEO 160 T QUIET	17193	232	320.5	570	156.5	145	261.5	170	135	85	5.5	360	A
LINEO 200 QUIET	17164												
LINEO 200 T QUIET	17194	322.5	417.5	625.5	194.5	195	363.5	190	120	155	5.5	510	B
LINEO 250 QUIET	17165												
LINEO 250 QUIET	17165	318	412	751.5	243	189.5	363.5	200	70	170	6.5	604.5	B
LINEO 315 QUIET	17166												
LINEO 315 QUIET	17166	415.5	496.5	940	307	244	441	309	110	255	8.5	780	B

VERZIA A

LINEO 100 QUIET - LINEO 100 T QUIET - LINEO 125 QUIET - LINEO 125 T QUIET
 LINEO 150 QUIET - LINEO 150 T QUIET - LINEO 160 QUIET - LINEO 160 T QUIET

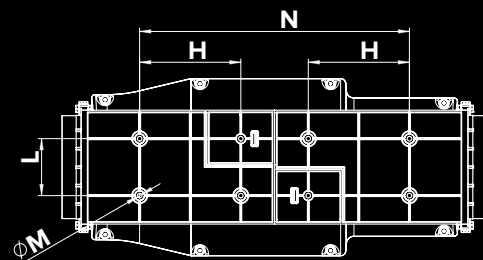
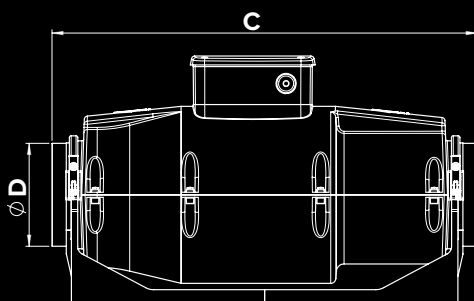
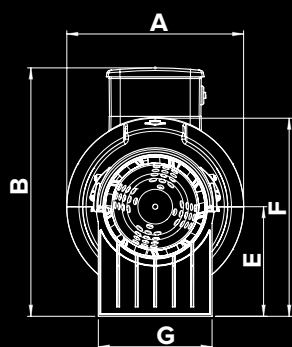

VERZIA B

LINEO 200 QUIET - LINEO 200 T QUIET - LINEO 250 QUIET - LINEO 315 QUIET

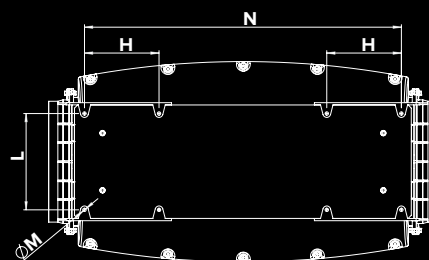
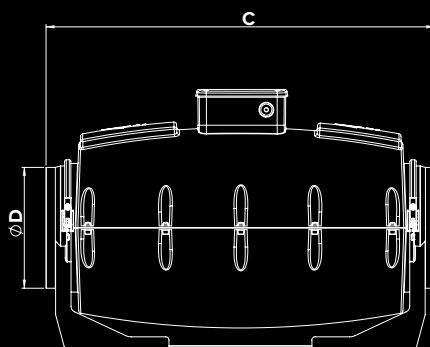
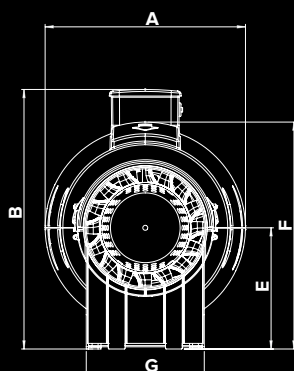

TLAKOVO-VÝKONOVÉ KRIVKY - LINEO QUIET

LINEO 100 QUIET - LINEO 100 T QUIET

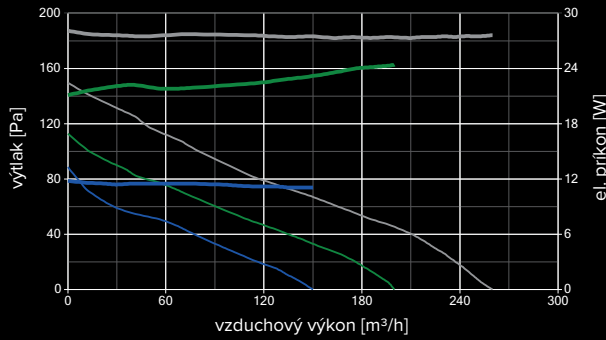

LINEO 125 QUIET - LINEO 125 T QUIET

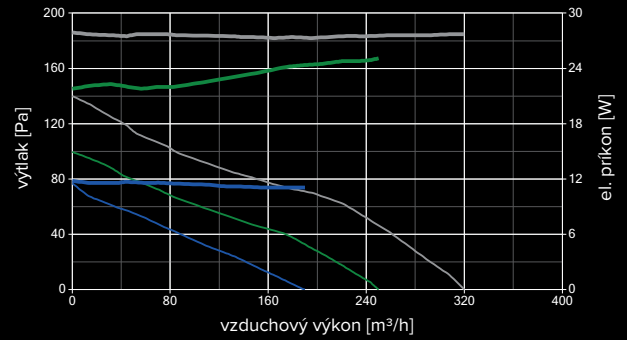

LINEO 150 QUIET - LINEO 150 T QUIET

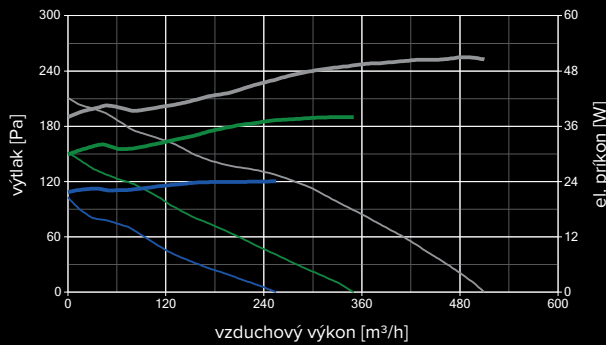

LINEO 160 QUIET - LINEO 160 T QUIET

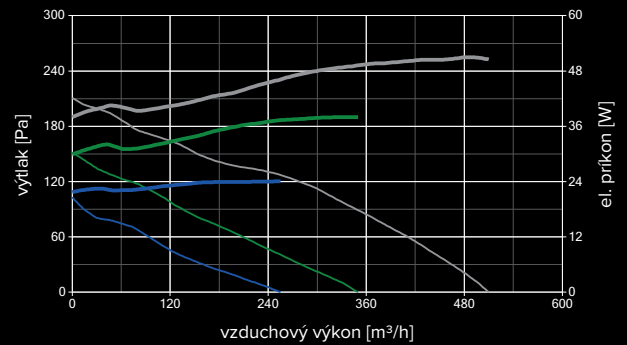

LINEO 200 QUIET - LINEO 200 T QUIET

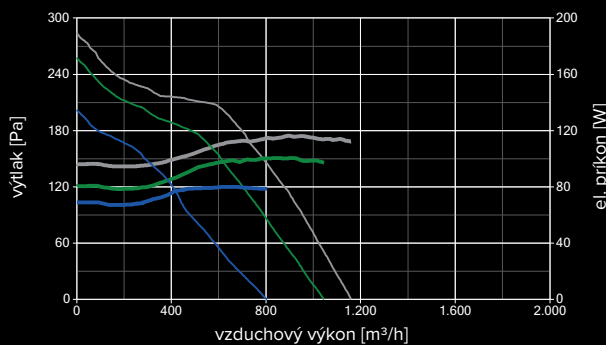

LINEO 250 QUIET

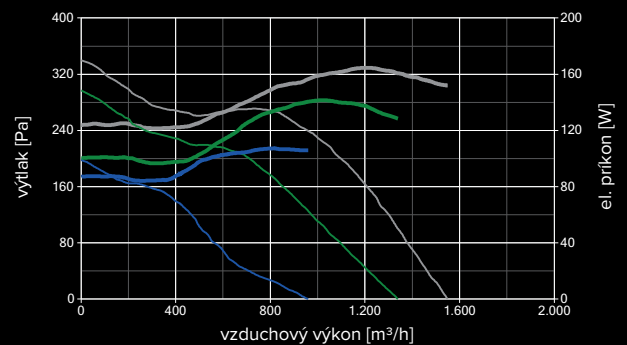

LINEO 315 QUIET

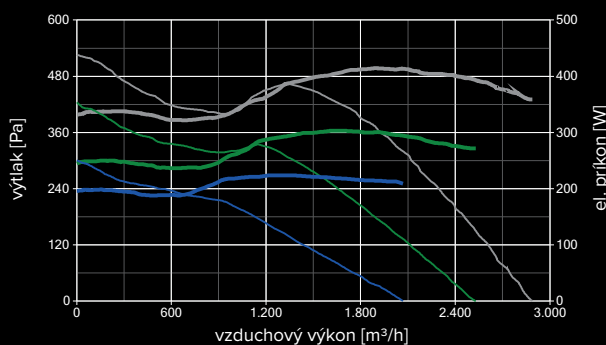

EL. PRÍKON	VÝKON
— max	— max
— str.	— str.
— min	— min

REGULÁTORY - LINEO QUIET

MODELY	POPIS	KÓD	KOMPATIBILITA
	C5 0.5 - (5-STUPŇOVÁ REGULÁCIA)	12987	17160 - 17161 - 17162 - 17163 - 17164 17165 - 17166
	C 1.5 (PLYNULÁ REGULÁCIA OTÁČOK, MAX 1.5 A)	12966	17160 - 17161 - 17162 - 17163 - 17164 17165 - 17166
	C 2.5 (PLYNULÁ REGULÁCIA OTÁČOK, MAX 2.5 A)	12967	17165 - 17166
	TRIO-LINEO 503 - (3-STUPŇOVÁ REGULÁCIA)	12891	17160 - 17161 - 17162 - 17163 - 17164 17165 - 17166 - 17190 - 17191 17192 17193 - 17194
	C TEMP - SNÍMAČ TEPLoty	12992	VŠETKY MODELY
	C SMOKE - SNÍMAČ PACHOV	12993	VŠETKY MODELY
	C HCS - SNÍMAČ VLHKOSTI	12994	VŠETKY MODELY
	C PIR - SNÍMAČ POHYBU	12998	VŠETKY MODELY
	C TIMER - ČASOVAČ	12999	VŠETKY MODELY

RAD LINEO

Potrubné ventilátory

Produkty radu LINEO sú vybavené viac otáčkovými indukčnými motormi.

NAJLEPŠÍ POMER MEDZI VÝKONOM,
SPOTREBOU A HLUKOM.

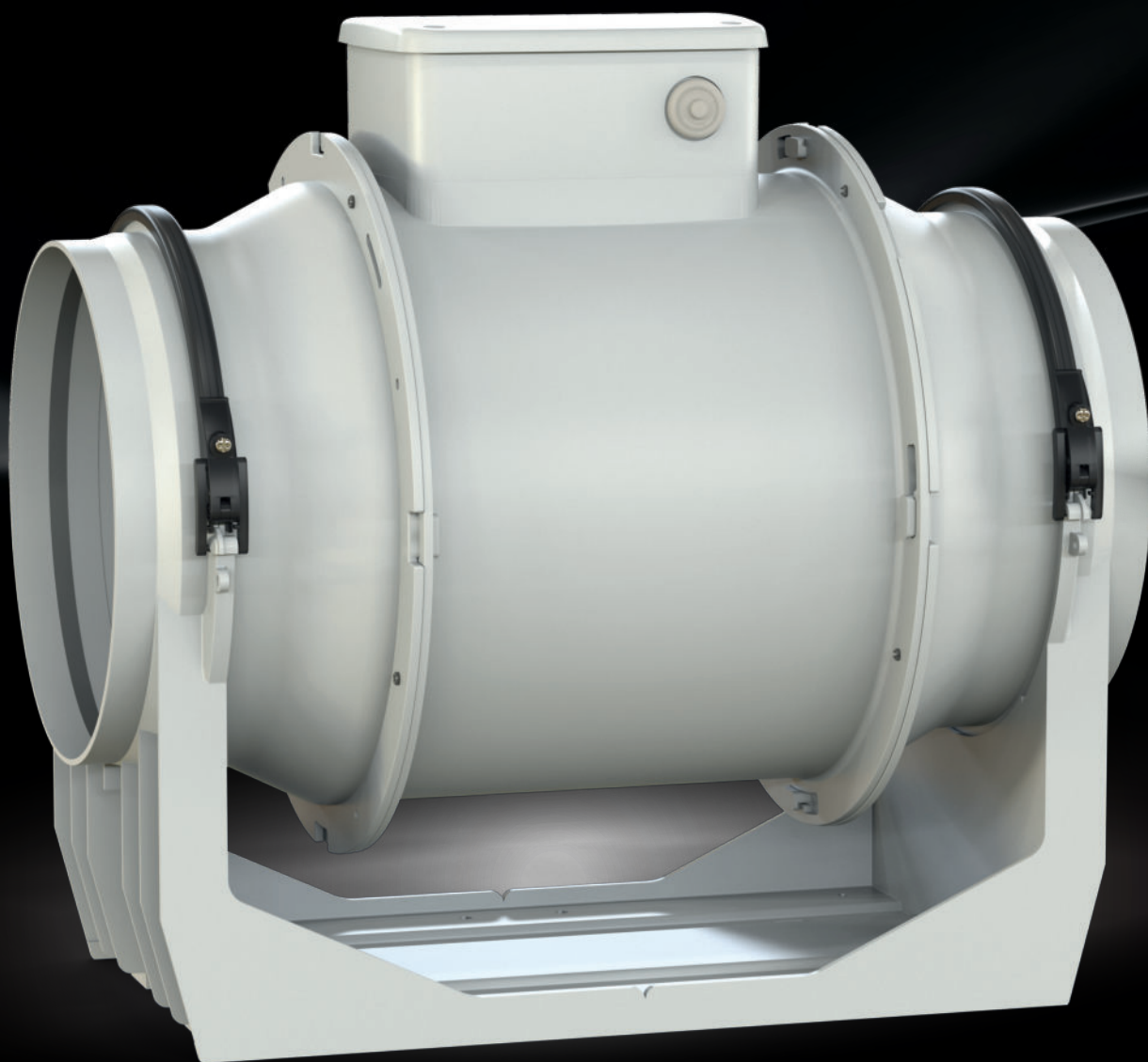

JEDNODUCHÁ A FLEXIBILNÁ INŠTALÁCIA

VLASTNOSTI A VÝHODY

- 26 modelov s pripojením na potrubie s priemerom 100 mm až 315 mm, z toho 18 modelov s AC motorom a 8 modelov s EC motorom.
- S alebo bez časovača (dobehu).
- Flexibilita a jednoduchosť inštalácie, ideálne na dosiahnutie špecifických požiadaviek na výkon a spotrebu s ohľadom na náklady



jednoduchá ÚDRŽBA

EL. KRABICA
Pripojenie el. napájania
/ umiestnenie riadiacej
dosky

NASÁVACÍ OTVOR
Pripojenie na potrubie

DIVERGENTNÝ ELEMENT
Slúži na zvýšenie výkonových
parametrov vrtule

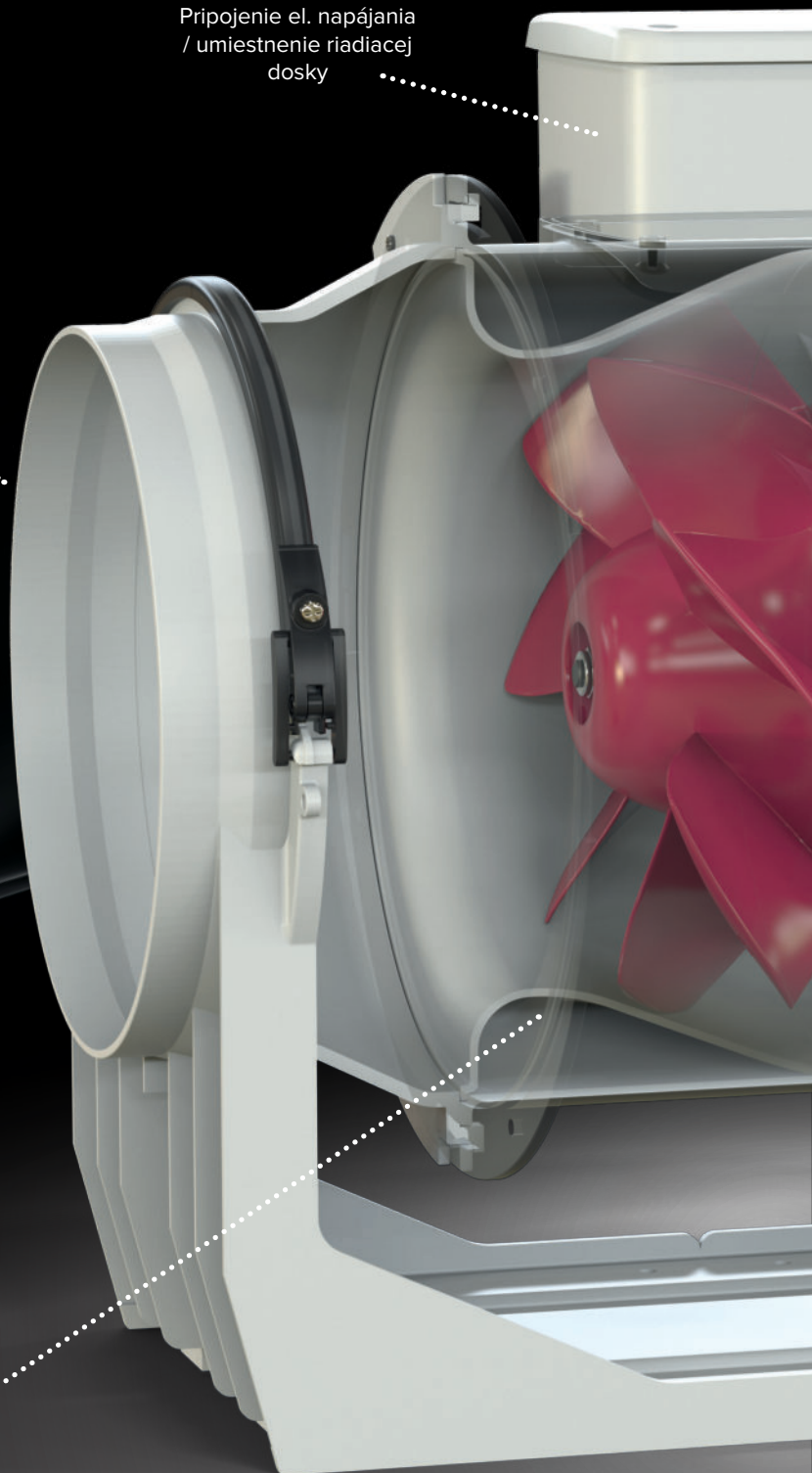

NOVÉ

RAD LINEO
Potrubné ventilátory



VRTUĽA

Navrhnutá pre dosiahnutie vyššej účinnosti a splnenie ErP

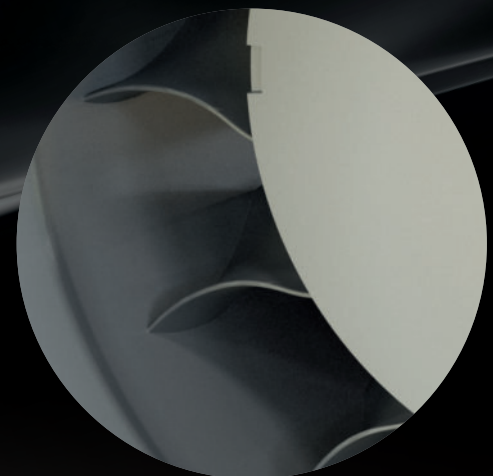
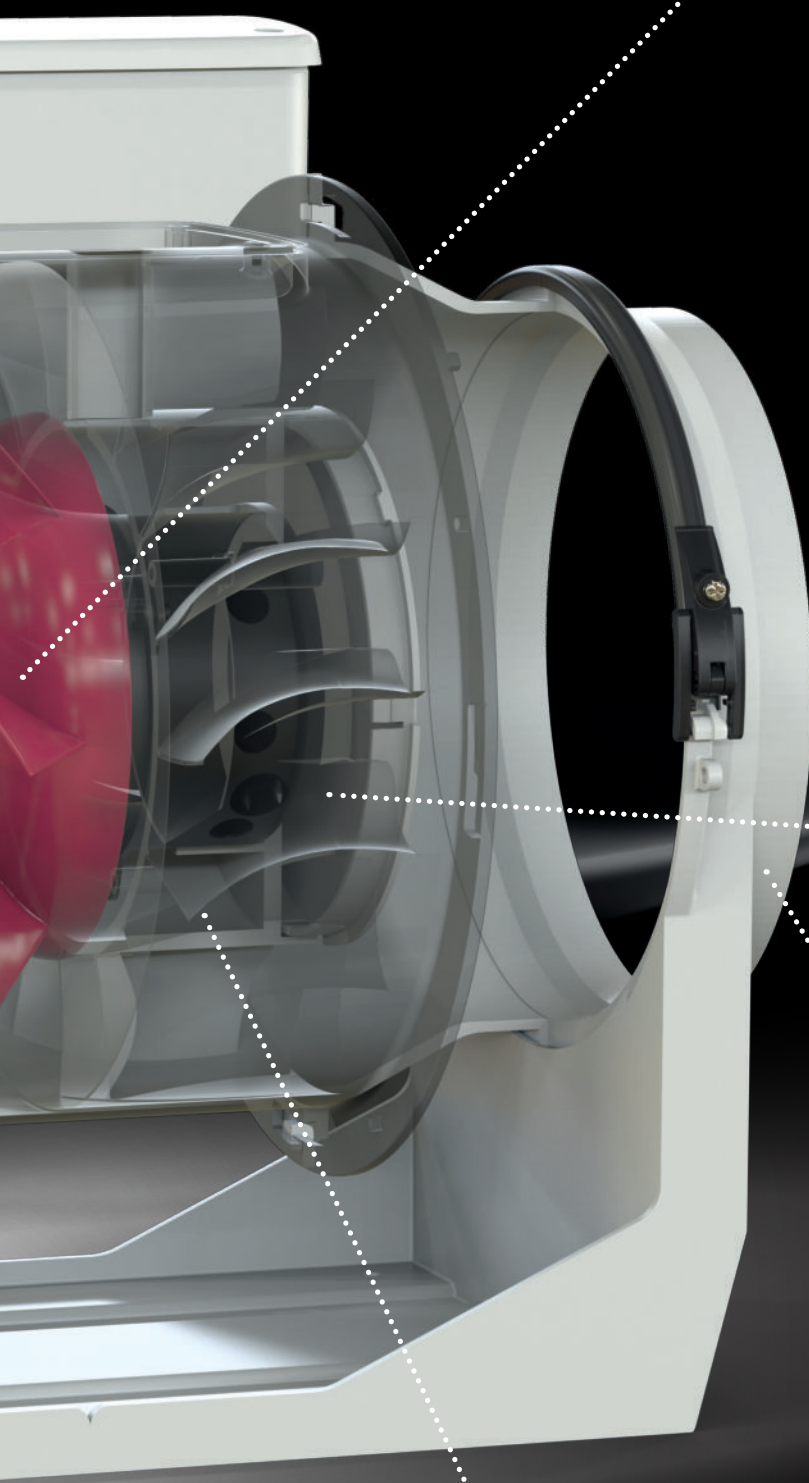

VÝFUKOVÝ OTVOR
Pripojenie na potrubie

USMERŇOVAČ PRIETOKU

Navrhovaný spolu s vrtuľou, na usmernenie prietoku a minimalizáciu turbulencií za vrtuľou

TECHNICKÉ A VÝKONOVÉ ÚDAJE - LINEO

Modely	Kód	El. napájanie 1f/50Hz (V)	El. príkon min/max (W)	El. prúd min/max (A)	Otáčky min/max (ot/min)	Vzduch. výkon min/max (m ³ /h)	Výtlak min/max (Pa)	Ak. tlak Lp min/max dB(A)*	Krytie**	Max. teplota (°C)	Hmotnosť (kg)
LINEO 100	17144	220-240	20	0.09	1520	180	127.5	30.7	IP44	60	1.8
LINEO 100 T	17185		23	0.11	2030	255	161.9	39.4			
LINEO 100 Q	17143	220-240	12	0.05	1860	155	63.8	29.4	IP44	60	1.8
LINEO 100 Q T	17184		15	0.9	2450	200	73.6	37.9			
LINEO 125	17145	220-240	25	0.11	1570	250	127.5	33.9	IP44	60	1.8
LINEO 125 T	17186		33	0.15	2140	365	166.8	43			
LINEO 150	17146	220-240	40	0.18	1580	385	206	41.4	IP44	60	2.5
LINEO 150 T	17187		58	0.26	2100	550	264.9	50.5			
LINEO 160	17147	220-240	40	0.18	1580	385	206	41.7	IP44	60	2.8
LINEO 160 T	17188		58	0.26	2100	550	264.9	50.8			
LINEO 200 Q	17148	220-240	45	0.22	1780	700	127.5	39.6	IP44	60	4.3
LINEO 200 Q T	17189		75	0.37	2740	950	284.5	49.0			
LINEO 250 Q	17149	220-240	85	0.40	1850	720	333.5	49.1	IP44	60	5.9
LINEO 250 Q T	17197		110	0.50	2550	990	519.9	56.2			

Modely	Kód	El. napájanie 1f/50Hz (V)	El. príkon min/str/max (W)	El. prúd min/str/max (A)	Otáčky min/str/max (ot/min)	Vzduch. výkon min/str/max (m ³ /h)	Výtlak min/str/max (Pa)	Krytie**	Max. teplota (°C)	Hmotnosť (kg)
NOVÉ LINEO 200	17180	220 - 240	80	0.34	1925	815	210.9	IPX5	50	4,9
NOVÉ LINEO 200 T	17177		95	0.42	2450	1025	267.7			
NOVÉ LINEO 250	17181	220 - 240	90	0.41	1500	725	136.5	IPX5	50	5,3
			120	0.54	2240	1145	284.4			
NOVÉ LINEO 315	17182	220 - 240	190	1.14	1770	1590	265.8	IPX5	50	9,5
			260	1.57	2300	2115	413.9			
			360	1.60	2690	2590				

* kalkulované vo voľnom priestore vo vzdialenosti 3m

** krytie platné pre ventilátory napojené na potrubie z oboch strán

HLUČNOSŤ - LINEO 200 - 250 - 315
AKUSTICKÝ VÝKON Lw dB (A)

Modely	Kód	NASÁVANIE			VÝFUK			DO OKOLIA		
		min	str.	max	min	str.	max	min	str.	max
LINEO 200	17180	80	86.4	89.5	78.6	74.9	88.2	57.4	63.7	67.5
LINEO 200 T	17177									
LINEO 250	17181	73.6	83.3	88.2	72.2	81.7	86.4	52.4	60	64
LINEO 315	17182	82.6	88.7	92	82	88.2	91.8	60.1	66.3	69.5

AKUSTICKÝ TLAK LP dB(A)**

Modely	Kód	NASÁVANIE			VÝFUK			DO OKOLIA		
		min	str.	max	min	str.	max	min	str.	max
LINEO 200	17180	62.5	68.8	72	61	67.4	70.7	36.9	43.1	46.9
LINEO 200 T	17177									
LINEO 250	17181	56.1	65.8	70.7	54.6	64.2	68.8	31.9	39.5	43.5
LINEO 315	17182	65	71.1	74.5	64.5	70.6	74.2	39.6	45.8	49

*** kalkulované vo voľnom priestore vo vzdialenosti 3m

ROZMERY - LINEO

Modely	Kód	A	B	C	Ø D	E	F	G	H	L	Ø M	N
LINEO 100	17144	188.5	211	303	96	101.5	189	90	60	80	5.5	-
LINEO 100 T	17185	188.5	211	303	96	101.5	189	90	60	80	5.5	-
LINEO 100 Q	17143	156	174	231	96	82	152	95	51.5	47.5	4.5	-
LINEO 100 Q T	17184	156	174	231	96	82	152	95	51.5	47.5	5.5	-
LINEO 125	17145	188.5	211	258	122	101.5	189	90	60	80	5.5	-
LINEO 125 T	17186	188.5	211	258	122	101.5	189	90	60	80	5.5	-
LINEO 150	17146	214.5	234	294	146	112.5	212	110	60	80	5.5	-
LINEO 150 T	17187	214.5	234	294	146	112.5	212	110	60	80	5.5	-
LINEO 160	17147	214.5	234	272.5	156	112.5	212	110	60	80	5.5	-
LINEO 160 T	17147	214.5	234	272.5	156	112.5	212	110	60	80	5.5	-
LINEO 200	17180	270	373	396	194.5	195	330	190	120	155	5.5	-
LINEO 200 T	17177	270	373	396	194.5	195	330	190	120	155	5.5	280
LINEO 200 Q	17148	234.5	266	300	196	125.5	235	140	94	100	5.5	-
LINEO 200 Q T	17189	234.5	266	300	196	125.5	235	140	94	100	5.5	-
LINEO 250	17181	300	378	322	243	190	329	200	70	170	5.5	174.5
LINEO 250 Q	17149	300	322	385	247	152.5	292	176.5	140	145	5.5	-
LINEO 250 Q T	17189	300	322	385	247	152.5	292	176.5	140	145	5.5	174.5
LINEO 315	17182	373	446	420	307	224	398	309	110	255	8.5	259.5

VERZIA A

LINEO 100 - LINEO 100 T - LINEO 125 - LINEO 125 T - LINEO 150 - LINEO 150 T
 LINEO 160 - LINEO 160 T - LINEO 200 Q - LINEO 200 Q T - LINEO 250 Q - LINEO 250 Q T

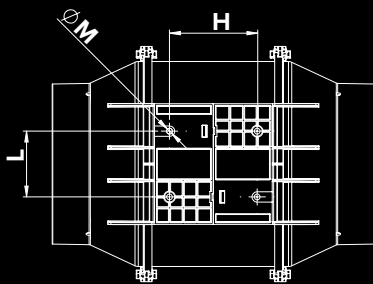

VERZIA B

LINEO 100 Q
 LINEO Q T

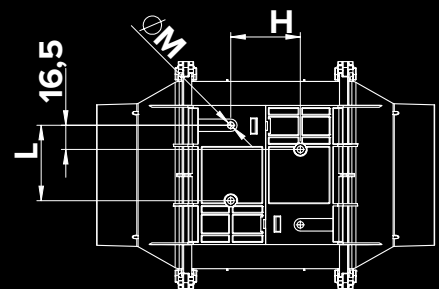

VERZIA C

LINEO 200 - LINEO 200 T - LINEO 250 - LINEO 315

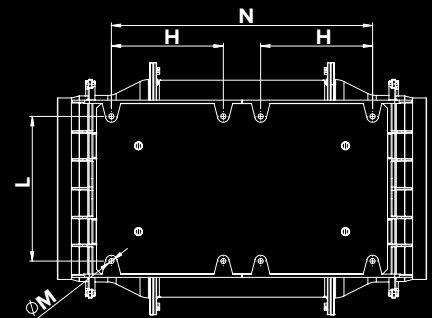
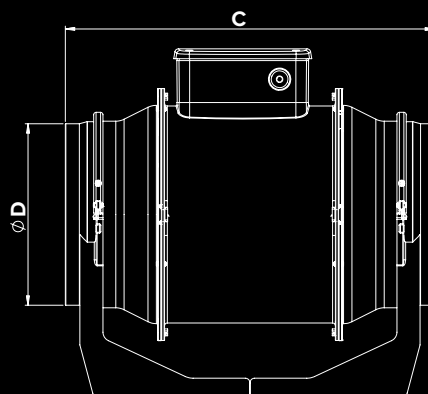
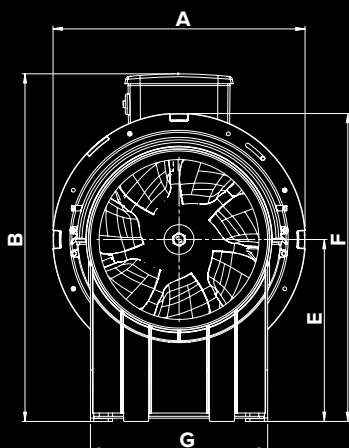

TLAKOVO-VÝKONOVÉ KRIVKY - LINEO

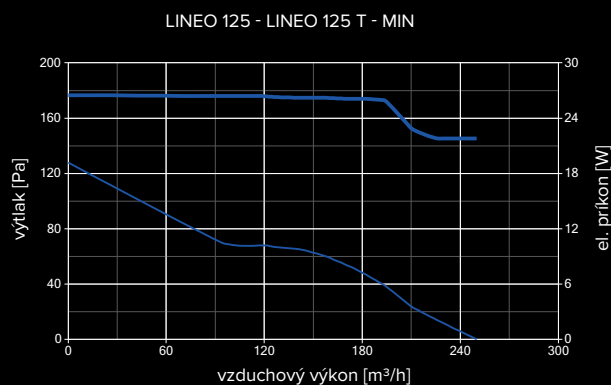
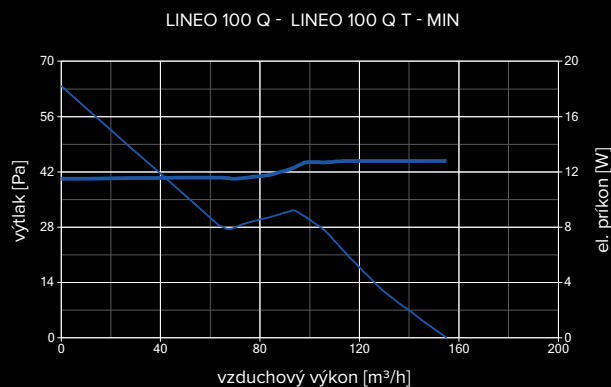
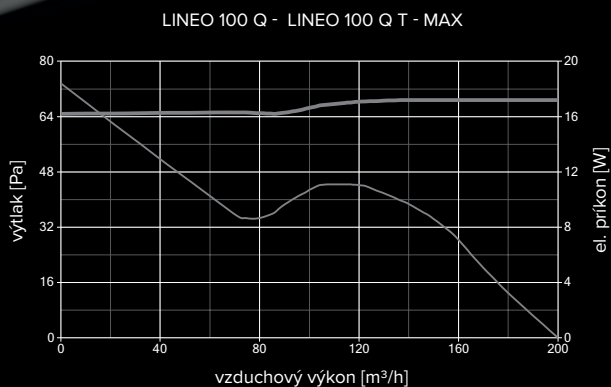
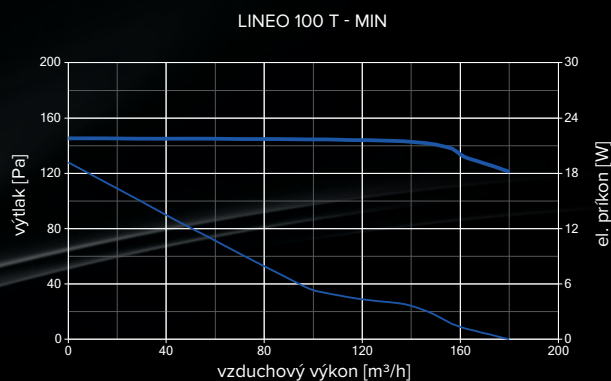
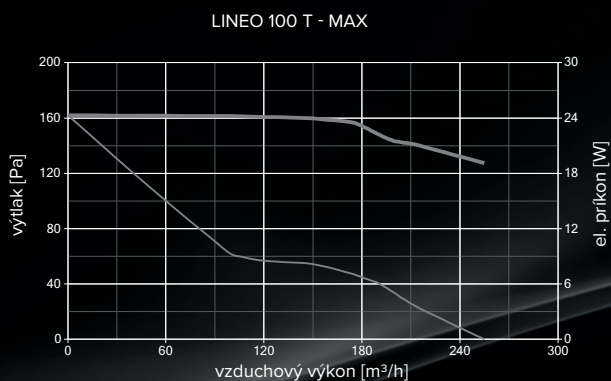
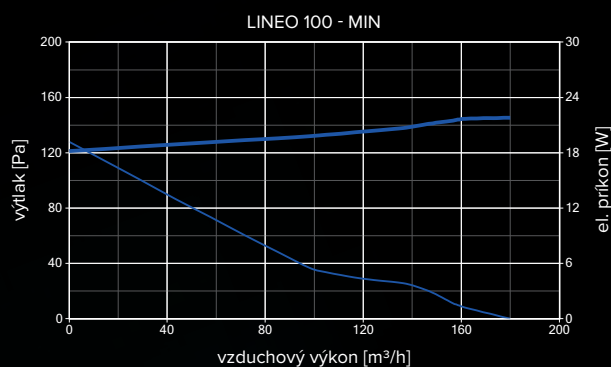
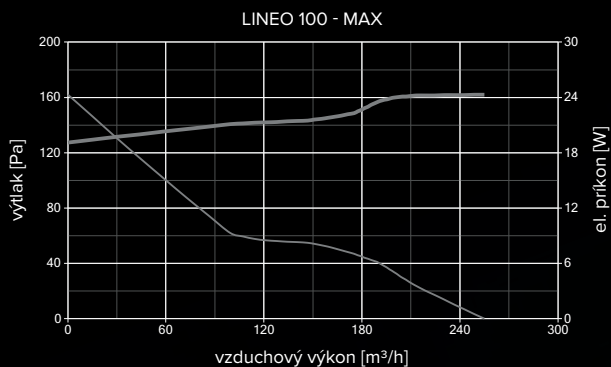

EL. PŘÍKON [W]
— max
— min

VÝKON
— max
— min

TLAKOVO-VÝKONOVÉ KRIVKY - LINEO

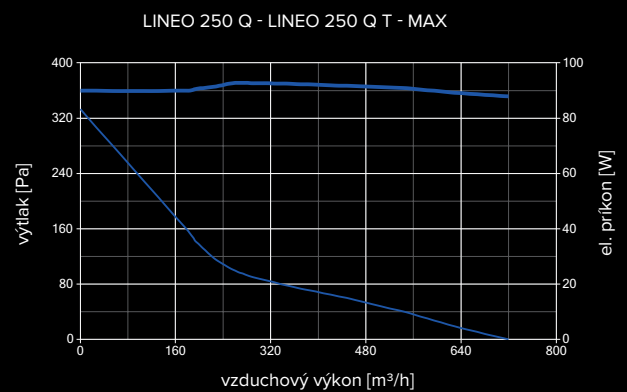
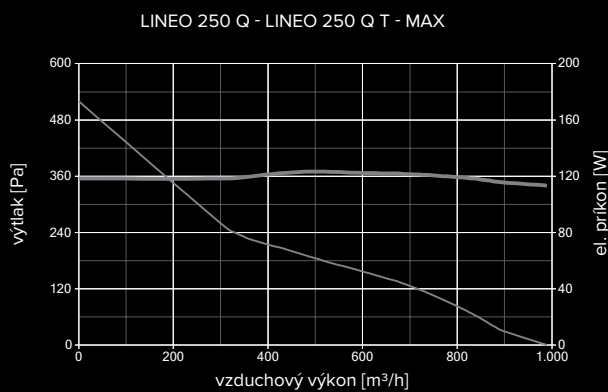
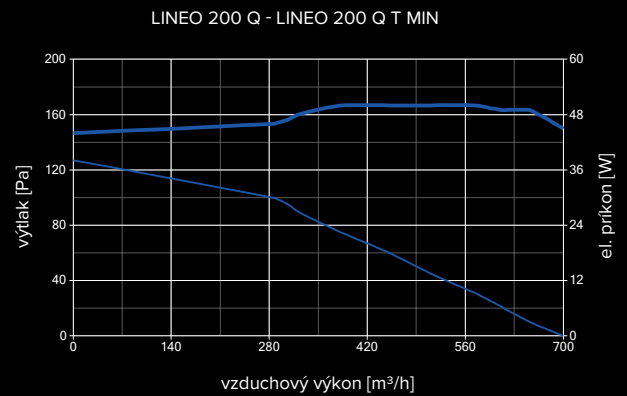
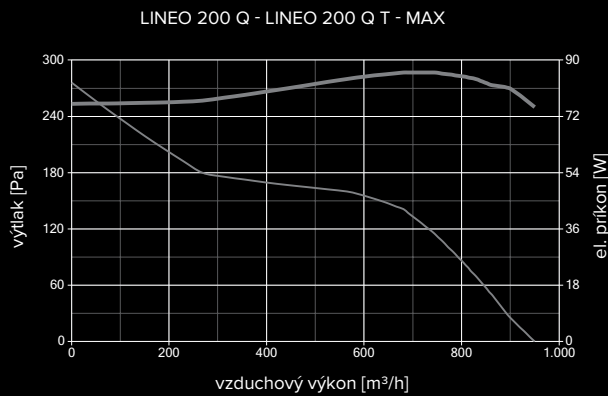
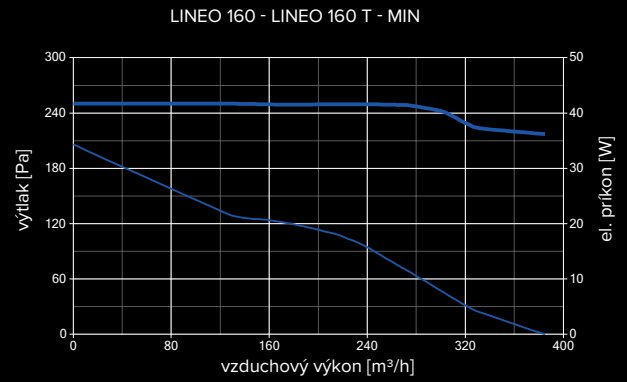
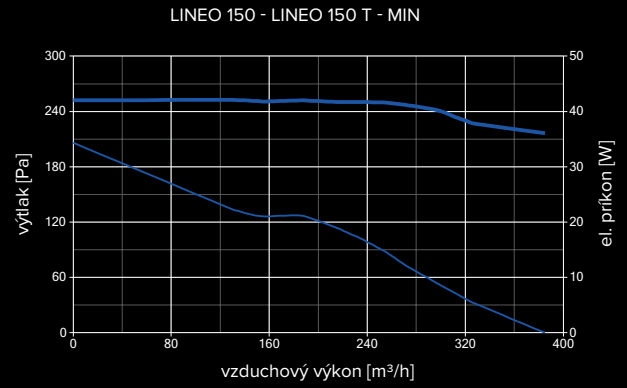
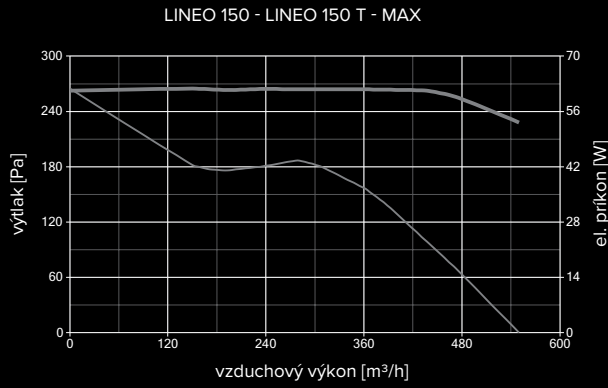

EL. PRÍKON [W]
 — max
 — min

VÝKON
 — max
 — min

TLAKOVO-VÝKONOVÉ KRIVKY - LINEO

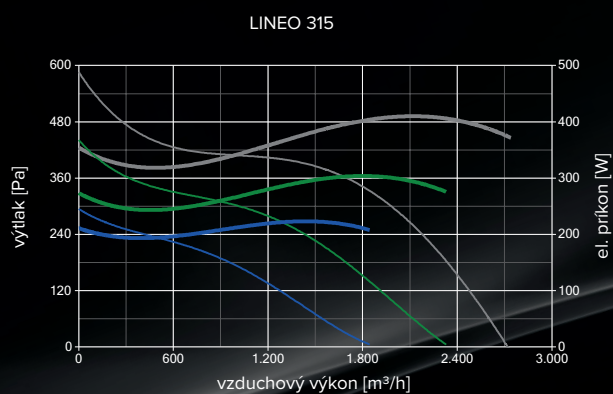
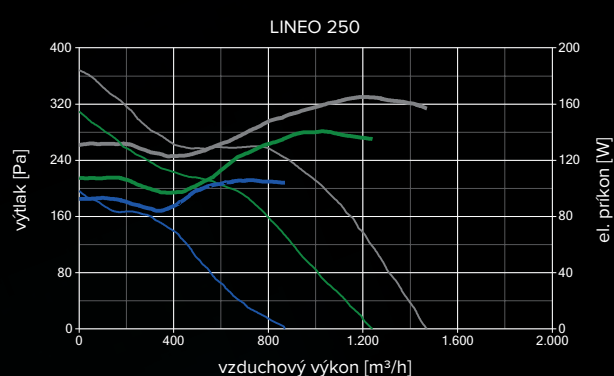
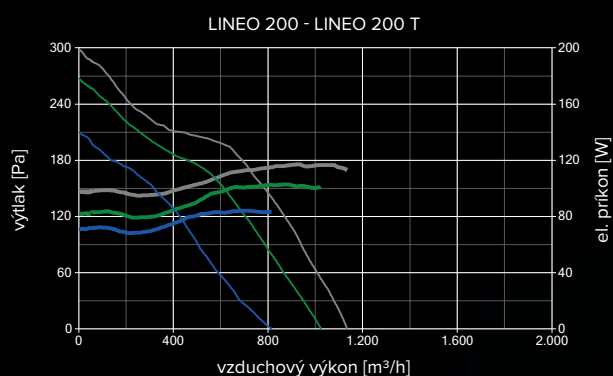

EL. PŘÍKON	VÝKON
— max	— max
— str.	— str.
— min	— min

NOVÉ

RAD LINEO

Potrubné ventilátory s AC motorom

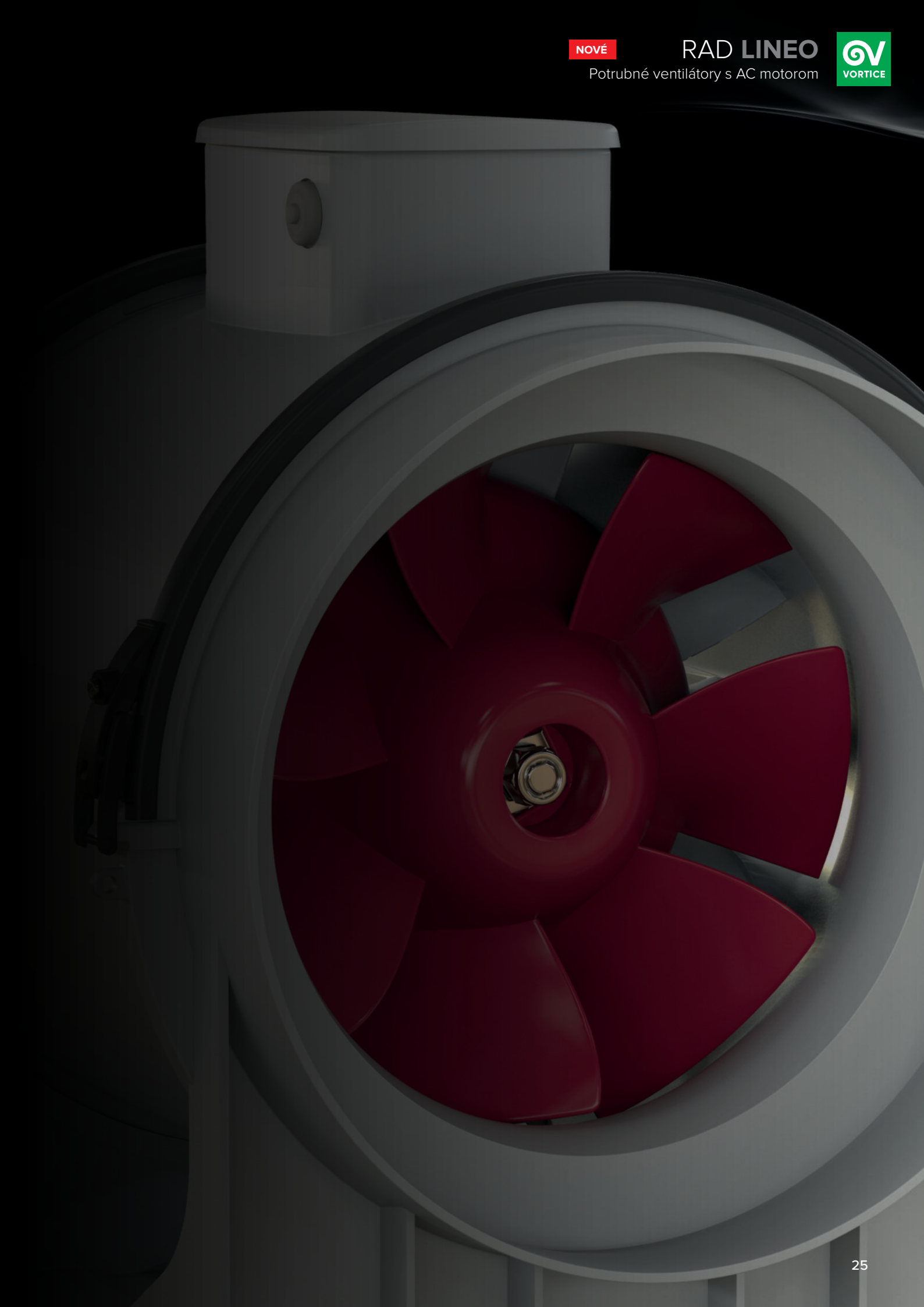

TECHNICKÉ A VÝKONOVÉ ÚDAJE - LINEO ES

Modely	Kód	El. napájanie 1~/50Hz (V)	El. príkon 4V/6V/8V/10V (W)	El. prúd 4V/6V/8V/10V (A)	Otáčky 4V/6V/8V/10V (ot/min)	Vzduch. výkon 4V/6V/8V/10V (m³/h)	Výtlak 4V/6V/8V/10V (Pa)	Krytie*	Max. teplota (°C)	Hmotnosť (kg)
LINEO 100 ES	17159	220 - 240	6.5	0.07	1070	140	36.3	IP45	60	2.3
			8.7	0.09	1345	175	59.8			
			16	0.15	1900	250	111.8			
			20	0.20	2220	305	258.9			
LINEO 100 Q ES	17158	220 - 240	4.5	0.05	900	60	8.8	IP45	60	1.8
			5.5	0.06	1235	80	16.7			
			9	0.08	2070	145	42.2			
			19	0.18	3230	235	96.1			
LINEO 125 ES	17178	220 - 240	7	0.07	1090	170	37.3	IP45	60	2.2
			10	0.10	1395	220	63.7			
			18	0.17	1940	315	115.7			
			25	0.25	2270	370	296.2			
LINEO 150 ES	17179	220 - 240	11	0.10	1260	290	83.4	IP45	60	2.6
			17	0.16	1595	370	135.3			
			34	0.30	2125	500	222.6			
			55	0.50	2480	590	433.5			
LINEO 160 ES	17183	220 - 240	12	0.11	1305	300	9	IP45	60	2.7
			19	0.17	1645	385	145.1			
			37	0.33	2165	510	230.5			
			60	0.55	2625	630	462.9			
NOVÉ LINEO 200 ES	17167	220 - 240	15.8	0.19	1380	560	90.2	IP45	50	4.6
			25.7	0.28	1700	700	141.2			
			52.8	0.53	2220	920	235.4			
			90	0.80	2680	1100	342.4			
NOVÉ LINEO 250 ES	17168	220 - 240	20	0.17	2270	755	107.9	IP45	50	5
			35	0.28	1695	935	165.7			
			75	0.61	1370	1235	283.4			
			126	1.00	2680	1475	396.2			
NOVÉ LINEO 315 ES	17169	220 - 240	45	0.37	1300	1415	143.2	IP45	50	9.2
			75	0.63	1600	1740	214.8			
			170	1.32	2130	2320	378.6			
			230	1.75	2370	2625	421.7			

* krytie platné pre ventilátory napojené na potrubie z oboch strán

HLUČNOSŤ - LINEO ES

AKUSTICKÝ VÝKON Lw dB (A)

Modely	Kód	NASÁVANIE				VÝFUK				DO OKOLIA			
		4V	6V	8V	10V	4V	6V	8V	10V	4V	6V	8V	10V
LINEO 100 ES	17159	63.3	69.4	78.2	82.6	62.1	68.4	77.5	82	35.5	39.5	47.8	52.3
LINEO 100 Q ES	17158	57.8	64.9	75.1	85.7	54.9	64.9	73.5	85.7	35.1	37.4	47.5	56.6
LINEO 125 ES	17178	64.1	68.2	76.7	81.4	63.6	68.6	77.5	81.5	36.8	40.5	48.8	52.2
LINEO 150 ES	17179	67.9	74.6	82.1	87.9	69.6	75.2	82.1	86.4	41.5	47.8	56.1	62.5
LINEO 160 ES	17183	68.4	76.4	83.1	87.5	69.1	76	82.8	86.9	42.4	49.4	57	62.3
LINEO 200 ES	17167	78.5	83.9	86.9	89.4	77.5	82.9	85.4	88.4	55.6	60.4	62.8	65
LINEO 250 ES	17168	74.2	79.1	85.1	88.9	74.4	79.2	84.9	88.5	49.5	54.3	61.4	64
LINEO 315 ES	17169	83.1	88	90.7	92.8	80.8	88.2	88.8	90	63	64.6	65.3	68.1

AKUSTICKÝ TLAK Lp dB(A)**

Modely	Kód	NASÁVANIE				VÝFUK				DO OKOLIA			
		4V	6V	8V	10V	4V	6V	8V	10V	4V	6V	8V	10V
LINEO 100 ES	17159	45.8	51.9	60.7	65.1	44.6	50.9	59.9	64.4	15	18.9	27.2	31.8
LINEO 100 Q ES	17158	40.2	47.3	57.6	68.2	37.3	47.4	56	68.1	14.6	16.9	27	36.1
LINEO 125 ES	17178	46.6	50.6	59.1	63.9	46	51.1	60	64	16.2	20	28.3	31.6
LINEO 150 ES	17179	50.4	57.1	64.6	70.3	52.1	57.7	64.5	68.9	21	27.2	35.5	41.9
LINEO 160 ES	17183	50.9	58.9	65.6	70	51.5	58.5	65.6	69.3	21.9	28.9	36.5	41.8
LINEO 200 ES	17167	60.9	66.4	69.4	71.9	60	65.3	67.9	70.8	35.1	39.9	42.3	44.5
LINEO 250 ES	17168	56.7	61.5	67.6	71.3	56.9	61.6	67.3	71	29	33.7	40.9	43.4
LINEO 315 ES	17169	65.6	70.4	73.2	75.3	63.3	70.6	71.2	72.4	42.5	44	44.8	47.5

** kalkulované vo voľnom priestore vo vzdialenosti 3m

ROZMERY - LINEO ES

Modely	Kód	A	B	C	Ø D	E	F	G	H	L	Ø M	N
LINEO 100 ES	17159	188.5	240	303	96	101.5	189	90	60	80	5.5	-
LINEO 100 Q ES	17158	156	205	231	96	82	152	95	51.5	47.5	4.5	-
LINEO 125 ES	17178	188.5	240	258	122	101.5	189	90	60	80	5.5	-
LINEO 150 ES	17179	214.5	265	294	146	112.5	212	110	60	80	5.5	-
LINEO 160 ES	17183	214.5	265	272.5	156	112.5	212	110	60	80	5.5	-
LINEO 200 ES	17167	270	372.5	396	194.5	195	330	190	120	155	5.5	280
LINEO 250 ES	17168	300	377.5	322	243	190	329	200	70	170	6.5	174.5
LINEO 315 ES	17169	373	506	420	307	224	398	309	110	255	8.5	259.5

VERZIA A

 LINEO 100 ES - LINEO 125 ES
 LINEO 150 ES - LINEO 160 ES

VERZIA B

LINEO 100 Q ES

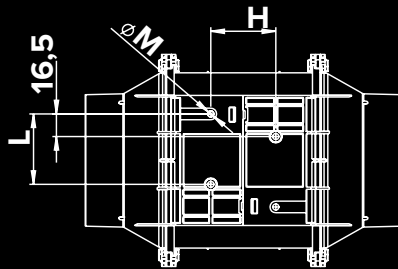
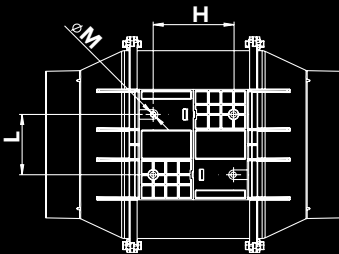
VERZIA C



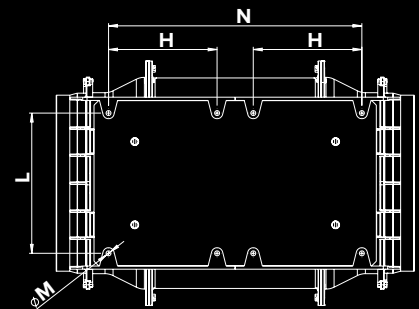
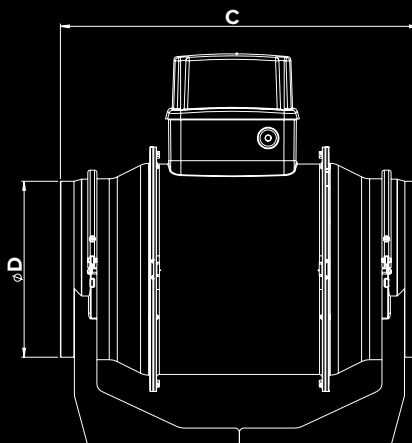
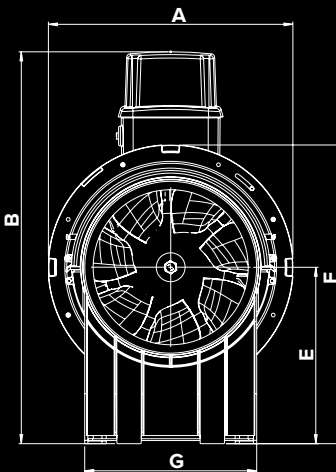

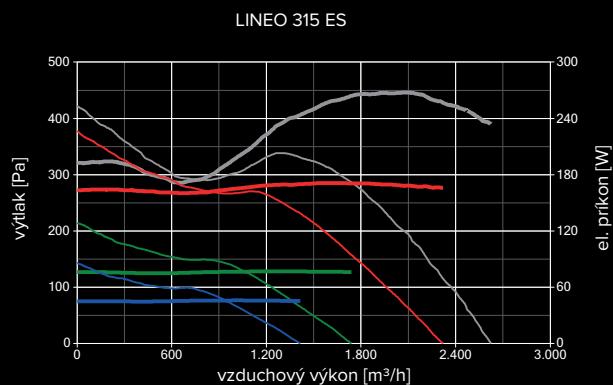
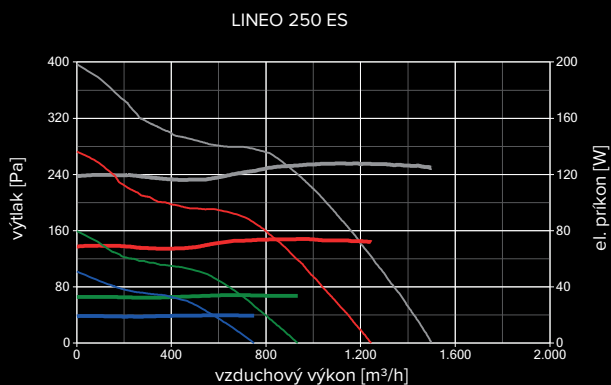
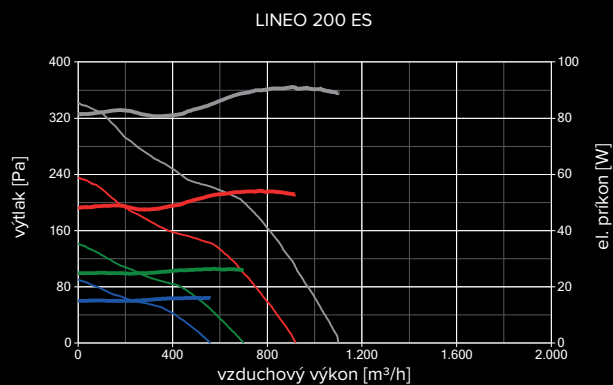
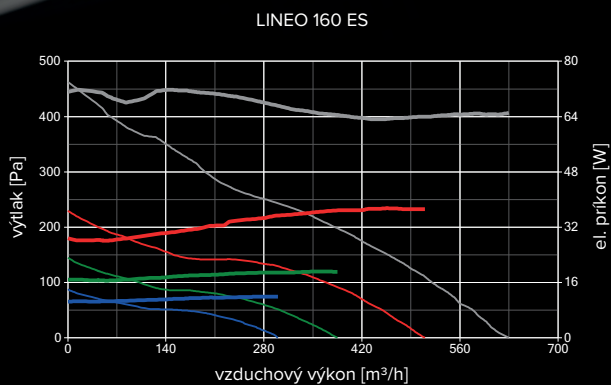
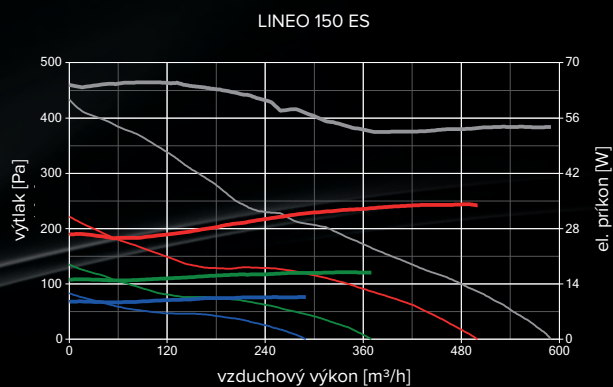
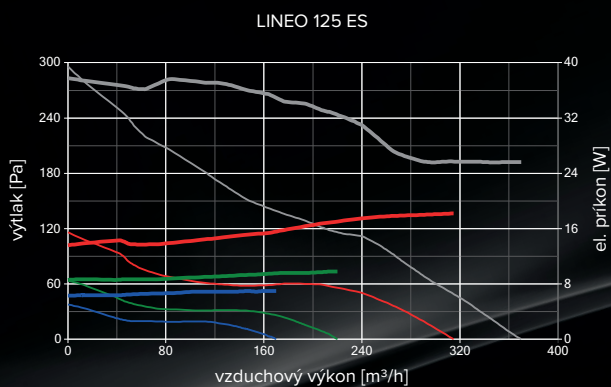
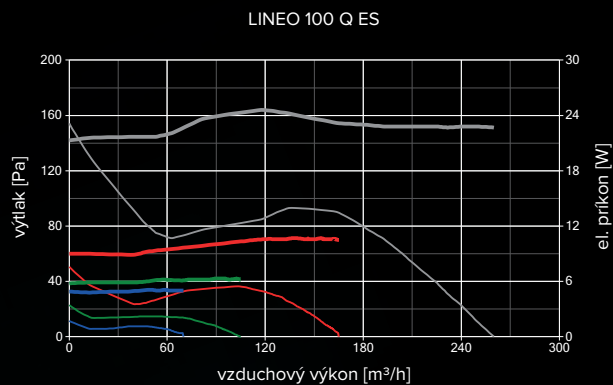
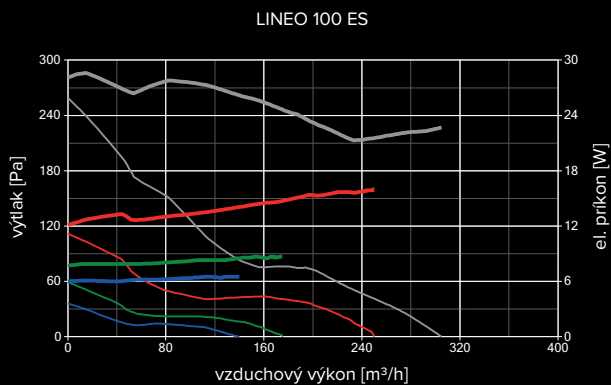

LINEO 200 ES - LINEO 250 ES - LINEO 315 ES



TLAKOVO-VÝKONOVÉ KRIVKY - LINEO ES



REGULÁTORY - LINEO

MODELY	POPIS	KÓD	KOMPATIBILITA
	C5 0.5 - (5-STUPŇOVÁ REGULÁCIA)	12987	17180
	C 1.5 (PLYNULÁ REGULÁCIA OTÁČOK, MAX 1.5 A)	12966	17180
	C 2.5 (PLYNULÁ REGULÁCIA OTÁČOK, MAX 2.5 A)	12967	17181 - 17182
	POT-IT - POTENCIOMETER 0-10V A PREPÍNAČ ZAP/VYP (VYŽADUJE KRABIČKU UNI 503)	12826	17158 - 17159 - 17179 - 17183 - 17187 17167 - 17168 - 17169
	POT - POTENCIOMETER 0-10V (VYŽADUJE KRABIČKU DIN)	12828	17158 - 17159 - 17179 - 17183 - 17187 17167 - 17168 - 17169
	TRIO-LINEO 503 - (3-STUPŇOVÁ REGULÁCIA)	12891	17181 - 17177 - 17182
	DUO - VYPÍNAČ A PREPÍNAČ OTÁČOK	22914	17144 - 17185 - 17143 - 17184 - 17145 17186 - 17146 - 17187 - 17147 - 1718 17148 - 17189 - 17149 - 17197
	C TEMP - SNÍMAČ TEPLoty	12992	VŠETKY MODELY
	C SMOKE - SNÍMAČ PACHOV	12993	VŠETKY MODELY
	C HCS - SNÍMAČ VLHKOSTI	12994	VŠETKY MODELY
	C PIR - SNÍMAČ POHYBU	12998	VŠETKY MODELY
	C TIMER - ČASOVAČ	12999	VŠETKY MODELY

VOLITEĽNÉ PRÍSLUŠENSTVO - LINEO

MODELY	POPIS	KÓD	KOMPATIBILITA	
	LINEO-C - SADA PRE MONTÁŽ 2 VENTILÁTOROV ZA SEBOU	100	22584	17159 - 17158
		125	22585	17178
		150	22586	17179
		160	22587	17183
		100	22577	17159 - 17158
	LINEO-PF - SADA PRE MONTÁŽ 2 VENTILÁTOROV VEDĽA SEBA	125	22578	17178
		150	22579	17179
		160	22581	17183
		17143 - 17184 - 17144 - 17185 - 17159 17158 - 17145 - 17186 - 17178 - 17146 17187 - 17179 - 17147 - 17188 - 17183 17148 - 17189 - 17180 - 17177 - 17167		
	LINEO-SF 500 - MONTÁŽNA PLATŇA	22593		
		22594		17149 - 17197 - 17168 - 17169
	LINEO-SF 700 - MONTÁŽNA PLATŇA	100	22701	17143 - 17184 - 17144 17185 - 17159 - 17158
		125	22702	17145 - 17186 - 17178
	LINEO-G - OCHRANNÁ MREŽKA	150	22703	17146 - 17187 - 17179
		160	22704	17147 - 17188 - 17183
		200	22705	17148 - 17189 - 17180 - 17177 - 17167
		250	22706	17149 - 17197 - 17168
		315	22707	17169







Predstavenie



Údržba a demontáž

Informácie v tomto katalógu sú orientačné a môžu byť zmenené bez predchádzajúceho upozornenia.

