

User's manual
(original instructions)

EN

Panasonic[®]

N421135A - Rev.01 - 10/2024

RAC Solo

P-MOG16* - P-MOZ20*
P-MOZ25* - P-MOZ30*

First of all, we would like to thank you for having chosen a device of our production.

We are sure you will be happy with it because it represents the state of the art in the technology of home air conditioning.

By following the suggestions contained in this manual, the product you have purchased will provide trouble free operation, giving you optimum room temperatures with minimum energy costs.

Panasonic Corporation

Conformity

Refer to the Installation Manual of the paired unit.

Markings



TABLE OF CONTENTS

1. Coding	4
1.1 Coding accessories.	4
2. General information	5
2.1 About the manual	5
2.2 General warnings	6
2.3 Disposal	6
3. Unit with touchpad and remote control	7
3.1 Interface	7
3.2 Main functions	8
3.3 Basic menu	10
3.4 Warnings.	11
4. Wall-mounted control PCZ-EEB749 / PCZ-EFB749	12
4.1 Interface	12
4.2 Main functions	13
4.3 Basic menu	14
4.4 Warnings.	15
5. Maintenance	16
5.1 Preliminary warnings	16
5.2 Routine maintenance	16
5.3 Long period shut-down	17
5.4 Suggestions for energy saving.	17
6. Troubleshooting	18
6.1 Troubleshooting table.	18
6.2 Troubleshooting	18
6.3 Maximum condensate collection level warning	18
6.4 Use of the appliance.	19
7. Technical information	20
7.1 Operating limits	20
7.2 RED Compliance Statement	20
7.3 Safety	20
7.4 FCC Declaration of Conformity.	20

1. CODING

⚠ The present manual refers to products in the RAC Solo range.





1.1 Coding accessories

	Accessory description	Combinable products	Code
Wall-mounted control panels			
Control panels			
	LED electronic control panel with touch interface, wall mounted complete with thermostat and room temperature and relative humidity probe. Cable connection. White colour	All	PCZ-EEB749
	LED electronic control panel with touch interface, wall-mounted complete with thermostat and room temperature and relative humidity probe with integrated Wi-Fi module. Cable connection. White colour	All	PCZ-EFB749

2. GENERAL INFORMATION

2.1 About the manual





This manual was written to provide all the explanations for the correct management of the appliance.

-  This instruction manual forms an integral part of the device and therefore must be carefully preserved and must ALWAYS travel with it, even if you transfer the device to another owner or relocate it to other premises. If the manual gets damaged or lost, download a copy from the website.
-  Read this manual carefully before proceeding with any operation and follow the instructions in the individual chapters.
-  The Manufacturer accepts no liability for damages to persons or property caused by failure to follow the instructions in this manual.
-  This document is restricted in use to the terms of the law and may not be copied or transferred to third parties without the express authorisation of the Manufacturer.

2.1.1 Editorial pictograms

The pictograms in the next chapter provide the necessary information for correct and safe use of the machine in a rapid and unmistakable way.

Related to security

-  **High risk warning (bold text)**
 - The operation described above presents a risk of serious physical injury, fatality, major damage to the appliance and/or to the environment if not carried out in compliance with safety regulations.
-  Low risk warning (plain text)
 - The operation described above presents a risk of minor physical injury or minor damage to the appliance and/or to the environment if not carried out in compliance with safety regulations.
-  Prohibition (plain text)
 - Refers to prohibited actions.
-  **Important information (bold text)**
 - This indicates important information that must be taken into account during the operations.



In the texts

- ▶ procedures
- lists

In the control panels

- ▶ actions required
- Expected responses following an action.*

In the figures

- 1 The numbers indicate the individual components.
- A The capital letters indicate component assemblies.
-  The white numbers in black marks indicate a series of actions to be carried out in sequence.
-  The black letter in white identifies an image when there are several images in the same figure.

2.1.2 Pictograms on the product

Symbols are used in some parts of the appliance:

Related to security



Read instruction manual

Read the instructions carefully before performing any work on the appliance.



Instruction manual

Read the information available in the technical documentation of the device.



Caution: electrical danger

- The concerned personnel is informed to the presence of electricity and the risk of suffering an electric shock.

2.1.3 Recipients

User

Non-expert person capable of operating the product in safe conditions for people, for the product itself and the environment, interpreting an elementary diagnostic of faults and abnormal operating conditions, carrying out simple adjustment, checking and maintenance operations.

Installer

Expert person qualified to position and connect (hydraulically, electrically, etc.) the unit to the plant; this person is responsible for handling and correct installation according to the instructions provided in this manual and the national standards currently in force.

Authorised Service Centre

Expert and qualified person authorised directly by the manufacturer to carry out all routine and supplementary maintenance operations, as well as every adjustment, check, repair and replacement of parts necessary during the life of the unit itself.

2.1.4 Manual organisation

The manual is divided into sections each dedicated to one or more target groups.

Coding

It addresses all recipients.
It contains the list of products and/or accessories referred to in the manual.

General information

It addresses all recipients.
It contains general information and important warnings that should be known before installing and using the appliance.

Control panels

It addresses all recipients.
It contains section by control mode and information on the use of the main functions.

Maintenance and Troubleshooting

It addresses all recipients.
It contains specific warnings and useful information for regular maintenance work.

2.2 General warnings

- ⚠ This instruction is an integral part of the booklet of the appliance.
- ⚠ The manufacturer reserves the right to make changes to its models at any time to improve its product, without prejudice to the essential characteristics described in this manual. The manufacturer is not obliged to add such modifications to machines previously manufactured, already delivered, or under construction.
- ⚠ All repair or maintenance interventions must be performed by an Authorised Service Centre or by professionally qualified personnel as foreseen in this booklet. Do not modify or intervene on the appliance as this could create dangerous situations and the Manufacturer will not be responsible for any damage caused.
- ⚠ Objects or structural obstacles (furniture, curtains, plants, leaves, blinds, etc.) must not obstruct the normal air flow both from the internal and from the external grilles.
- ⚠ Do not put any containers on top of the appliance, especially if they contain liquids, as this could cause a short circuit or cause damage to the appliance and/or be exposed to danger of electrocution.
- ⚠ Do not lean on the appliance.
- ⚠ In the event of water leaks, turn off the appliance and disconnect the electric power supply. Call an Authorised Service Centre.
- ⚠ In case of replacement of parts, use only original parts.
- ⚠ The unit can be used by children over the age of 8, and by people with reduced physical, sensory or mental capabilities, or with no experience or necessary knowledge, as long as they are monitored or after they have received instructions on the safe use of the unit and have understood the dangers involved. Children must not play with the appliance. The cleaning and maintenance that must be performed by the user should not be carried out by children without supervision.

2.3 Disposal



The symbol on the product or packaging indicates that the product must not be treated as normal household waste, but must be taken to the appropriate collection point for recycling of used electrical and electronic equipment and batteries.

Proper disposal of this product avoids harm to humans and the environment and promotes the reuse of valuable raw materials.

For more detailed information about the recycling of this product, contact your local authority, your household waste disposal service or the shop where you purchased the product.

Illegal disposal of the product by the user involves the application of the administrative sanctions provided for by the regulations in force.

This provision is valid in the EU Member States.



This symbol might be used in combination with a chemical symbol.

In this case, it complies with the requirement set by the Directive for the chemical involved.

3. UNIT WITH TOUCHPAD AND REMOTE CONTROL

⚠ The touchpad control is supplied as standard installed on the unit.

⚠ If the unit with touchpad and remote control is combined a wall control (Cod. PCZ-EEB749 - PCZ-EFB749), the change of functions is only possible via the wall control.

⚠ The on-board display works in display-only mode.

3.1 Interface

3.1.1 Description

The touchpad control is supplied as standard on board the unit, does not require any connections and enables:

- show the operating status
- show any alarms
- select the various functions

The remote control allows you to:

- select the various functions

⚠ The remote control supplied with the device is designed to provide maximum sturdiness and exceptional functionality, but should nonetheless.

⚠ The keys of the remote control and touch-screen display perform the same function.

⚠ Handle with care.

⚠ Warnings:

- do not expose the remote control to rain or contact with liquids
- do not expose the remote control to direct sunlight
- handle with care avoiding strong impacts or falling on hard surfaces
- do not place obstacles between the remote control and the device while you are using the remote

⚠ If other devices are being used within the premises that are operated by remote control (TVs, radios, stereos, etc.), you might experience some interference.

⚠ Electronic and fluorescent lamps can interfere with communications between the remote control and the device.

⚠ Electronic and fluorescent lamps can interfere with communications between the remote control and the device.

3.1.2 Touchscreen display

Keys and functions related.

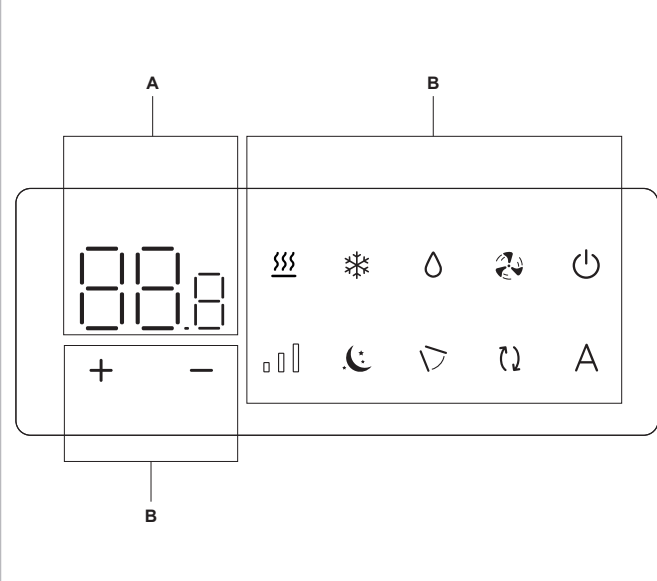

A	Display area
B	Keys area
	Setpoint
	Up key
	Down key
	Allows you to select the Heating mode of operation
	Allows you to select the Cooling mode of operation
	Allows you to activate the Dehumidification function
	Allows you to activate the Ventilation function
	This can be used to switch the unit on or off
	Allows you to control ventilation speed
	Enables the Night function
	Allows you to activate the Moving Deflector Control function
	Allows you to activate the Air Change function (not visible on base unit)
	Enables the Automatic function

3.1.3 Remote control

Keys and functions related.

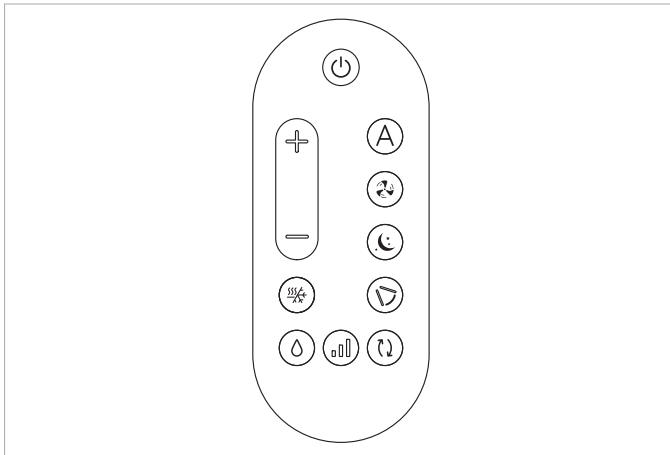

	Up key
	Down key
	This can be used to switch the unit on or off
	Enables the Automatic function
	Allows you to activate the Ventilation function
	Enables the Night function
	Allows you to activate the Moving Deflector Control function
	This can be used to select the operating mode (Cooling or Heating)
	Allows you to activate the Dehumidification function
	Allows you to control ventilation speed
	Allows you to activate the Air Change function (not visible on base unit)

Inserting the battery

⚠ Use only a dry 3 V lithium battery CR2430 (included) with the remote control.

To insert the battery:

- ▶ open the slot on the bottom of the remote control

- ▶ insert the battery according to the +/- polarity
- ▶ close the cover after inserting the battery

⚠ Used batteries must be disposed of appropriately through special waste collection centres provided by the local authorities.

3.2 Main functions

⚠ The keys of the remote control and touchpad perform the same function.

3.2.1 General start-up

Before the activation:

- ⚠** Make sure the device is connected to the power supply.
- ⚠** In case of a master switch on the power supply line, switch on the system by operating the switch.

To control the device with the remote control or touch-screen display:

- ▶ insert the power plug of the unit into the power socket of the system

To activate the touchpad

- ▶ press and hold for 2 seconds

The device turns on.

The preset set-point appears on the 3 digits of the display.

Correct use of the remote control:

- Point the front of the remote towards the unit's display, the buzzer will emit a beep and a message will appear on the display to confirm that the command has been enabled
- The maximum range to send commands is about 8 metres.

3.2.2 Operating mode set-up

to switch the operating mode

- ▶ press one of the following keys for about 2 seconds

The symbol on indicates the Heating function enable

⚠ The device heats the room with setpoint higher than the room temperature.

⚠ In this mode of operation, the appliance periodically performs a defrosting of the evaporation coil. During this phase, the appliance does not heat the room.

The symbol on indicate the Cooling function enable

⚠ The unit cools and dehumidifies the room with setpoint below room temperature.

⚠ Ventilation is maintained even if the setpoint is reached.

3.2.3 Put on stand-by

To put on stand-by

- ▶ press for 2 seconds

The device turns off.



⚠ If you plan to keep the device out of service for a prolonged time:

- ▶ disable the device
- ▶ disconnect the main breaker
- ▶ removing the power plug

⚠ The device is equipped with a memory so all settings will not be lost either in case of power off or in case of power failure.

3.2.4 Set room temperature



To set-up the temperature

- ▶ operate the   keys to decrease or increase the desired value
The value changes.

- ⚠ The room temperature set-point can range between 16 and 31 °C.
- ⚠ Setting temperatures too low or too high is detrimental to health and an unnecessary waste of energy.

3.2.5 Automatic Function







To select the Automatic function

- ▶ press  for 2 seconds
The symbol  on indicates the Automatic function enable.

- ⚠ Ventilation speed is automatically adjusted for optimal comfort. The unit automatically selects the operation mode and ventilation speed according to the set temperature.

3.2.6 Ventilation speed regulation



To adjust the ventilation speed

- ▶ press   in sequence to set the ventilation speed
 -  Minimum ventilation speed.
 -  Medium ventilation speed.
 -  Maximum ventilation speed.
 -  Flashing indicates Booster ventilation speed.

- ⚠ Booster ventilation speed:
 - is only available for Heating and Cooling operation
 - is only activated for 90 minutes
 - after 90 minutes, the Automatic function is set for 30 min and the Booster ventilation cannot be selected again
 - after 30 min you can select the Booster ventilation speed again
- ⚠ This function is not available for functions:
 - Dehumidification
 - Night

3.2.7 Dehumidification Function



To select the Dehumidification function

- ▶ press  for 2 seconds
The  symbol on indicates the Dehumidification function is activated.

- ⚠ In this mode, the device dehumidifies the room.
- ⚠ In this mode of operation, speed settings are ignored and the device operates only in minimum speed.

3.2.8 Ventilation Function



To select the Ventilation function

- ▶ press  for 2 seconds
The  symbol on indicates the Ventilation function is activated.

- ⚠ In this mode of operation, the compressor is never activated and the unit exerts no action on either temperature or humidity. The only action possible is the choice of ventilation speed.

3.2.9 Night function



To select the Night function

- ▶ press  for 2 seconds
The symbol  on indicate the Night function enable.

- ⚠ This mode of operation maximizes the quietness of the appliance, saving electricity and regulating nighttime well-being.
- ⚠ In this mode the fan is set to minimum speed.
- ⚠ The set temperature is automatically changed:
 - in Heating mode, decreases by - 1 °C after one hour and by another - 1 °C after two hours
 - in Cooling mode, increases by 1 °C after one hour and by another + 1 °C after two hours
 - after 2 hours the temperature set is no longer changed
 - after 6 hours, the device is put into standby mode
- ⚠ This function is not available for functions:
 - Dehumidification
 - Ventilation
 - Automatic
- ⚠ This function can be excluded at any time by pressing the button again.

3.2.10 Moving Deflector Control function active



To activate the Moving Deflector Control function

- ▶ press  for 2 seconds
*The symbol  on indicates the Moving Deflector Control function is activated.
The continuous swinging of the moving air outlet deflector is activated.*

- ⚠ Never force the flow deflector manually to move it.
- ⊖ It is forbidden to force the movement of the moving deflector manually.
- ⚠ In Heating or Cooling operation, the deflector position is reset every 30 minutes to prevent dew formation.



You can lock the moving deflector at the position you want to direct the airflow.

To lock the moving deflector and direct the air flow

- ▶ press  for 2 seconds
*The symbol  off indicates the Moving Deflector Control function is off.
The moving air outlet deflector locks in the desired position.*

3.2.11 Key lock

To set-up the key locking

- ▶ press  and  at the same time for about 5 seconds
 appears to confirm key lock.

Pressing any key on the display shows .

 Setting the key lock also locks the remote control.

 All settings are inhibited by the user.



 Repeat the sequence to unlock the control.

3.3 Basic menu



To access the basic menu

- ▶ press  for 10 seconds
Appears .

To move within the menu or change values

- ▶ use  



To select a menu item and to confirm the changes made

- ▶ press 
The menu item is selected and the settings are accessed.
Changes are confirmed when the symbol  appears.

To exit menu items without saving

- ▶ press 
You exit the selected menu item.

To exit the basic menu

- ▶ press once 
Appears --.
- ▶ press  again
You exit the basic menu.

 After a period of 30 seconds from the last action, the display turns off.

3.3.1 Menu items

CF: Scale

Ub: Buzzer volume

oH: Temperature offset in Heating

oC: Temperature offset in Cooling

Ht: Not used

ur: Wi-Fi reset

uP: Wi-Fi pairing

3.3.2 Scale

To change the temperature unit of measure

- ▶ select 
- ▶ select °C or °F
By default the temperature unit of measure is °C.

3.3.3 Buzzer volume

To change the volume

- ▶ select 
The volume setting range is from 00 (min) to 03 (max).

 The volume changes after change is confirmed.

3.3.4 Temperature offset in Heating

To set the temperature offset in Heating

- ▶ select 
The temperature offset setting range in Heating is from -9 °C (minimum) to 9 °C (maximum).

 The range for °F is smaller, equivalent to -5 °C/5 °C.

3.3.5 Temperature offset in Cooling









To set the temperature offset in Cooling

- ▶ select 
The temperature offset setting range in Cooling is from -9 °C (minimum) to 9 °C (maximum).

 The range for °F is smaller, equivalent to -5 °C/5 °C.









3.3.6 Wi-Fi reset

To reset the Wi-Fi credentials and return the device to its original configuration

- ▶ select 
- ▶ press  to change settings
- ▶ use the   icons in sequence
Appears .
- ▶ press 
- ▶  appears to reset Wi-Fi credentials.
- ▶ press  to confirm
Credentials have been reset.

3.3.7 Activate Wi-Fi

To activate Wi-Fi

- ▶ select 
- ▶ press  to change settings
- ▶ use the   icons in sequence
Appears .
- ▶ press 
- ▶  appears to enable Wi-Fi pairing.
- ▶ press  to confirm

 The device remains visible on Aquarea Home App for the first 15 minutes after the device is switched on.

3.4 Warnings

3.4.1 Operating the unit if the remote control is not available

If you lose the remote control, the batteries run out or the remote stops working, you can operate the device with the keys on the touch-screen display on-board the machine.

3.4.2 Visualisation of alarms on display

⚠ In the event of an alarm, the device still maintains active functions.

⚠ A flashing  symbol and alarm code are displayed on the touchpad to indicate alarms.

Alarm codes

- ▶ Er01 Room temperature sensor disconnected or faulty
- ▶ Er02 Internal heat exchanger temperature error
- ▶ Er03 Source fluid temperature sensor error
- ▶ Er04 Source heat exchanger temperature sensor error
- ▶ Er05 Internal fan speed out of range (min/max)
- ▶ Er06 External fan speed out of range (min/max)
- ▶ Er07 Driver Communication failure
- ▶ Er08 Delivery temperature probe error
- ▶ Er09 Remote function error
- ▶ Er10 Condensate level in the bowl too high
- ▶ CP CP contact activation
- ▶ Er12 Compressor driver failure
- ▶ Er16 No refrigerant / 4-way valve malfunction
- ▶ Er17 Driver malfunction / Compressor mismatch
- ▶ Er19 Heating element temperature probe error
- ▶ Er20 Error second temperature probe of the external exchanger
- ▶ Er22 Incorrect power supply
- ▶ Er23 UV lamp error

4. WALL-MOUNTED CONTROL PCZ-EEB749 / PCZ-EFB749

4.1 Interface

4.1.1 Description

LED electronic control panels with touch interface for wall installation allow:

- room temperature control
- management of the main functions of the device
- temperature and humidity measurement
- fan speed regulation

They are fitted with:

- internal memory with data saving even in case of shut-down or power outage

⚠ After 20 seconds after the last action the panel brightness is reduced, only the room temperature is seen on the display.

⚠ The maximum brightness is restored to the pressure of any key.

⚠ For wall control coding PCZ-EFB749, the Aquarea Home App is available.

4.1.2 Display

Status and active alarms on display.

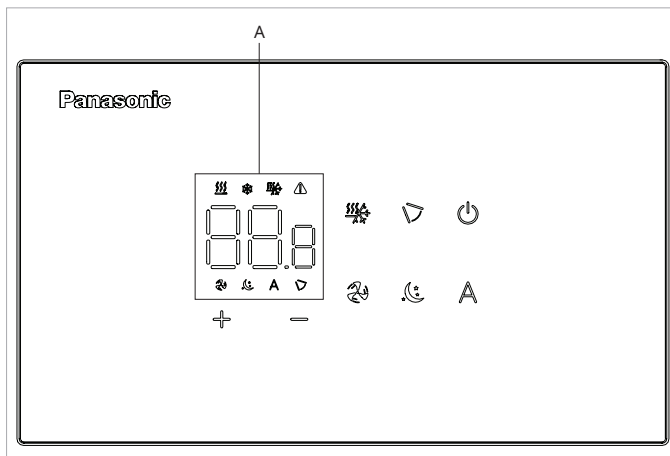

A	Display area
888	Setpoint
⚠	Alarm signals
↙	Moving Deflector Control function active
🌀	Active ventilation function
🔥	Heating / Cooling (Cannot be used)
❄️	Cooling operating mode active
🔥	Heating operating mode active
⌂	Automatic function active
🌙	Night function active

4.1.3 Keys functions

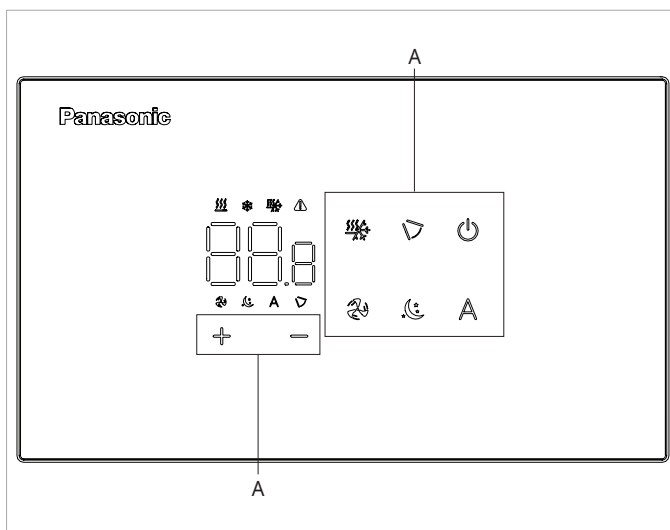

A	Keys area
+	Up key
-	Down key
⏻	This can be used to switch the unit on or off
↙	Allows you to activate the Moving Deflector Control function
🌀	Allows you to control ventilation speed
🔥/❄️	This can be used to select the operating mode (Cooling or Heating) or Autochangeover
⌂	Enables the Automatic function
🌙	Enables the Night function



4.2 Main functions

4.2.1 General start-up

Before the activation:



- ⚠ Make sure that the remote control is connected to the mains.
- ⚠ In case of a master switch on the power supply line, switch on the system by operating the switch.

To activate

- ▶ press  for 2 seconds
- ▶  appears on the screen.
- ▶ The device turns on.

4.2.2 Put on stand-by

To put on stand-by

- ▶ press  for 2 seconds
- ▶  appears on the screen.
- ▶ The control goes out.

- ⚠ In stand-by mode, the control guarantees antifreeze protection.
- ⚠ In case of temperature <5 °C, the hot water solenoid valve outputs and boiler consent are activated automatically.

4.2.3 Set room temperature



To set-up the temperature

- ▶ operate the  keys to decrease or increase the desired value
- ▶ The value changes.

- ⚠ The room temperature set-point can range between 16 and 31 °C.
- ⚠ Setting temperatures too low or too high is detrimental to health and an unnecessary waste of energy.

4.2.4 Heating operation



To select the Heating operation

- ▶ press  for about 2 seconds
- ▶ The symbol  on indicates the Heating function enable

- ⚠ In heating function the symbol is alight with setpoint higher than the room temperature.



4.2.5 Cooling Operation

To select the Cooling operation

- ▶ press  for about 2 seconds
- ▶ The symbol  on indicate the Cooling function enable.

- ⚠ In cooling function the symbol is alight with setpoint lower than the room temperature.



4.2.6 Automatic change of heating/cooling operation mode

- ▶ press  until the  symbol appears on the display
- ▶ the symbol of the active operation mode appears
- ▶ the device independently decides the correct mode of operation

- ⚠ Changing from one operation mode to the other involves a waiting time of 40 minutes.

4.2.7 Selection of ventilation power level

To adjust the power level

- ▶ press the  key in sequence
- ▶ L1 minimum power level
- ▶ L2 average power level
- ▶ L3 maximum power level
- ▶ L4 booster power level
- ▶ When the  symbol is pressed, the letters L1/L2/L3/L4 appear for a few seconds, indicating which ventilation power level the device is at



- ⚠ Each power level corresponds to a matched ventilation speed.

- ⚠ When the wall control is connected to the appliance, the on-board display shows the ventilation power level via the  symbol. Refer to the "Ventilation speed regulation" p. 9 section for more guidance.

4.2.8 Functioning in automatic mode

- ⚠ The power output level and ventilation speed are adjusted independently according to the temperature difference between the set temperature and the temperature detected in the room.



To select functioning in automatic mode

- ▶ press the key 
- ▶ The  symbol on the display indicates that the device is operating in automatic mode.

- ⚠ If automatic adjustment is on, the level and power are automatically selected based on the distance and time to the setpoint.

4.2.9 Functions in night mode

To select the Night function

- ▶ press the key 
- ▶ The symbol  on the display indicates that the fan is operating in minimum mode.

- ⚠ This mode of operation maximizes the quietness of the appliance, saving electricity and regulating nighttime well-being.

- ⚠ In this mode the fan is set to minimum speed.

- ⚠ This function can be excluded at any time by pressing the button again.

4.2.10 Set the key lock

To set-up the key locking

- ▶ press and at the same time for about 5 seconds
 appears to confirm key lock.

Pressing any key on the display shows .

- ⚠ Setting the key lock also locks the remote control.
- ⚠ All settings are inhibited by the user.
- ⚠ Repeat the sequence to unlock the control.

4.3 Basic menu

To access the basic menu

- ▶ with the display off, hold down for 10 seconds
The device turns on and appears
- ▶ keep pressed until the indication appears
- ▶ release the key
The symbol appears

To navigate in the menu

- ▶ use the icons

To select a menu item and to confirm the changes made

- ▶ press the icon
Confirming the change takes you to the next item.

To exit the menu

- ▶ press the icon for 10 seconds
- ▶ or wait 30 seconds the automatic shutdown

- ⚠ After a period of 30 seconds from the last action, the display turns off.

4.3.1 Menu items

ot: AIR probe offset (air probe setting)

ur: Value read by the R.H. sensor

ut: Probe Offset PT4

uS: Humidity setpoint

uI: Humidity hysteresis

CF: Scale

ub: Buzzer volume

uu: Wi-Fi reset

up: Wi-Fi pairing

- ⚠ Menu items uu and up are visible only on the command with Wi-Fi link code PCZ-EFB749.

4.3.2 Set AIR probe offset

To set the air probe offset

- ▶ select
- ▶ press to change settings
- ▶ increase or decrease the value with the icons
- ▶ press to confirm
*By default it is set to -2,5°C.
The setting range is from a minimum of -12.0 °C to a maximum of 12.0 °C.*

4.3.3 Set probe offset RH

- ⚠ Modify only after real deviations from an actual measurement has been established with professional equipment.

To set the RH probe offset

- ▶ select
- ▶ press to change settings
- ▶ increase or decrease the value with the icons
- ▶ press to confirm
By default it is set to -2.

4.3.4 Set the humidity setpoint

To set the humidity setpoint

- ▶ select
- ▶ press to change settings
- ▶ increase or decrease the value with the icons
- ▶ press to confirm
*By default it is set to 50.
The setting range is from 20.0% to 90.0%.*

4.3.5 Setting the humidity hysteresis

To set the humidity hysteresis

- ▶ select
- ▶ press to change settings
- ▶ increase or decrease the value with the icons
- ▶ press to confirm
*By default it is set to 5.
The setting range is from 1 (min) to 30 (max).*





4.3.6 Scale

To change the temperature unit of measure

- ▶ select
- ▶ press to change settings
- ▶ select °C or °F
- ▶ press to confirm
By default the temperature unit of measure is ° C.

4.3.7 Adjusting the volume





To change the volume



- ▶ select 
- ▶ press  to change settings
- ▶ increase or decrease the value with the icons  
- ▶ press  to confirm
By default it is set to 1.
The volume setting range is from 00 (min) to 03 (max).

 The volume changes after confirming the modification.

4.3.8 Wi-Fi reset

To reset the Wi-Fi credentials and return the device to its original configuration

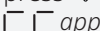







- ▶ select 
- ▶ press  to change settings
- ▶ use the   icons in sequence
Appears 

- ▶ press 
-  appears to reset Wi-Fi credentials.
- ▶ press  to confirm
Credentials have been reset.

 The function is only available for wall controls with Wi-Fi connection code PCZ-EFB749.

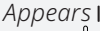
4.3.9 Activate Wi-Fi

To activate Wi-Fi

- ▶ select 
- ▶ press  to change settings
- ▶ use the   icons in sequence
Appears 
- ▶ press 
-  appears to enable Wi-Fi pairing.
- ▶ press  to confirm

 The device remains visible on Aquarea Home App for the first 15 minutes after the device is switched on.



 The function is only available for wall controls with Wi-Fi connection code PCZ-EFB749.

4.4 Warnings

4.4.1 In case of blockage

 This procedure should only be carried out in the event that the control locks and no longer responds to commands.

In case of control blockage

- ▶ press both keys  and  for 10 seconds
 appears on the display accompanied by a beep.
The device has been reset.

4.4.2 Alarm display on wall control panel

 In the event of an alarm, the device still maintains active functions.

 Alarm codes are shown on the on-board display. Refer to the "Visualisation of alarms on display" *p. 11* chapter for the complete list.

5. MAINTENANCE

5.1 Preliminary warnings

Before each cleaning and maintenance intervention:

- ▶ disconnect the device from the power supply by turning the system main switch to "OFF"
- ▶ wait for the components to cool down in order to avoid any burns
- ⊖ Carrying out any technical or cleaning work before disconnecting the unit from the power supply is forbidden.
- ⚠ Make sure that there is no voltage before operating.
- ⚠ After completing the maintenance work, the unit must be restored its original condition.
- ⚠ Handle refrigerant with care. Leaking refrigerant can cause freezing.

5.2 Routine maintenance

The routine maintenance plan includes the following cleaning operations.

5.2.1 External cleaning

Clean the external surfaces with a soft damp cloth.

- ⚠ Disconnect the unit from the power supply before each cleaning and maintenance intervention by setting the main power supply switch to off.
- ⚠ Do not use abrasive sponges, or abrasive or corrosive detergents, as you might damage the painted surfaces.

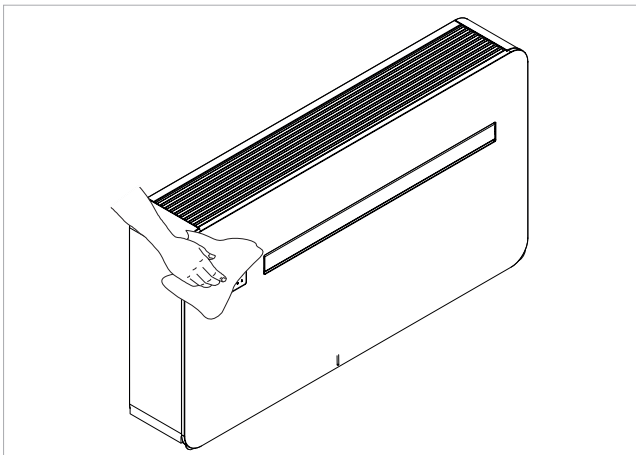

5.2.2 Cleaning the filters

Clean the air filter after a period of continuous use and according to the concentration of impurities in the air, or when you wish to start-up the appliance after a period of inactivity.

- ⚠ The filter is located in the bottom part of the appliance.

5.1.1 Specific warnings R32

- ⚠ R32 refrigerant gas is mildly flammable and odourless.
- ⚠ Check that there are no sources of ignition in continuous operation (open flames, gas appliances, electric stoves, lighted cigarettes, etc.).
- ⊖ Smoking in the vicinity of the appliance is prohibited.
- ⊖ Using a mobile phone near the appliance is prohibited.
- ⊖ Using leak detectors with halogen lamps is prohibited.

- ⚠ Wait for the components to cool down in order to avoid any burns.

- ⚠ Pay attention to the sharp edges.

To extract the filter

- ▶ lift the fin grille slightly
- ▶ rotate the fin grille until it comes completely out of the housing
- ▶ remove the grille
- ▶ extract the filter by lifting it

To clean the filter:

- ▶ use a vacuum cleaner
- ▶ aspirate dust

If the quantity of dust is considerable:

- ▶ wash the filter under running water (max. 40 °C)
- ▶ allow to dry in an area out of direct sunlight

- ⚠ Exposure to the sun or washing water temperatures above 40 °C can shrink the filters.

- ⊖ It is forbidden to use detergents or solvents to clean the filter.

To reassemble the filter:

- ▶ bring the filter closer to the unit
- ▶ insert the filter into its housing
- ▶ bring the finned grille closer
- ▶ insert the grille into the appropriate slots
- ▶ rotating the grille
- ▶ hooking the grille

- ⚠ After filter cleaning check if the panel is properly mounted.

- ⊖ It is forbidden to use the device without mesh filter.

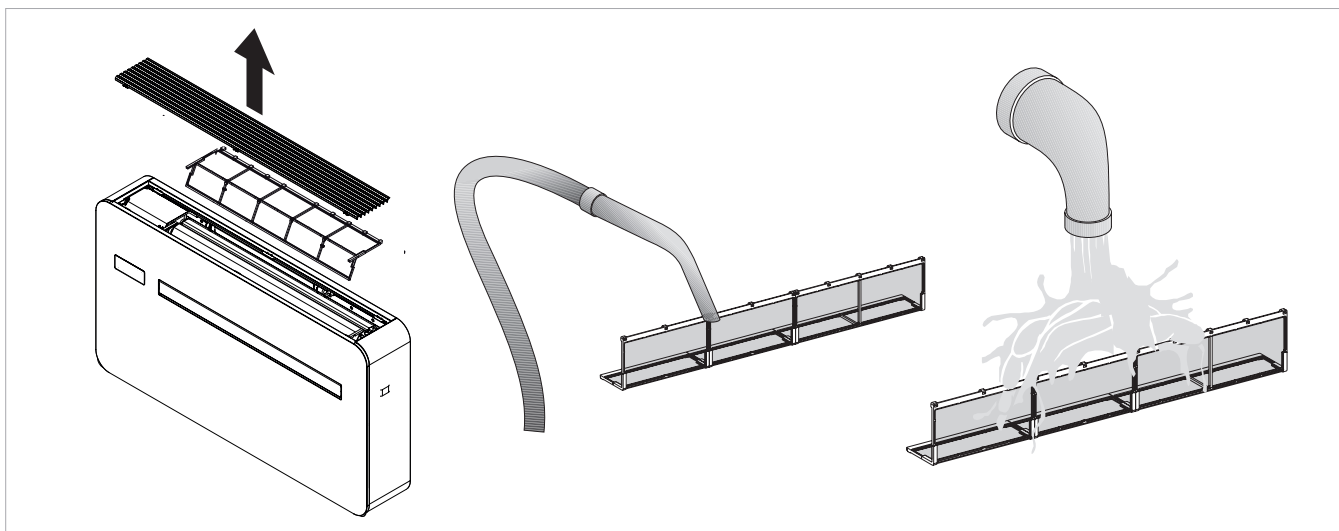

5.3 Long period shut-down

For seasonal shutdowns or for long periods:

- ▶ disable the device

- ▶ set the main system switch to "OFF"

⚠ The antifreeze function is not on.

5.4 Suggestions for energy saving

- Keep filters clean at all times.
- Keep doors and windows of rooms to be air-conditioned closed.
- Avoid direct sun rays.
- Do not obstruct the airflow in and out of the device.

6. TROUBLESHOOTING

6.1 Troubleshooting table

In the event of a malfunction, please refer to the following table. If, after performing the suggested checks, the prob-

lem is not solved, please contact the Authorised Technical Assistance.

Anomalies	Possible causes	Remedies
The appliance doesn't switch on	No power supply	Check there is power supply (by turning a light on, for example). Check that the thermal-magnetic circuit breaker used exclusively to protect the appliance has not been tripped (if it has, reset it). If the problem repeats immediately, please call the Service Centre and avoid trying to make the appliance work.
	Remote control batteries have run out	Check that the appliance can be turned on using the touch-screen display and substitute the batteries.
The appliance does not cool/heat adequately.	The temperature set is too high or too low.	Check and, if necessary, adjust the temperature setting on the remote control
	The air filter is clogged	Check the air filter and clean it if necessary
	Check that there are no other obstacles to the air flow both inside and outside the appliance.	Remove anything that might block the air flow.
	The heating and cooling load has increased (for example, a door or a window has been left open or an appliance has been installed in the room which generates a lot of heat).	Try to reduce the heating and cooling load of the room following instructions below: Cover large windows exposed to sunlight with curtains or with external maskings (blinds, porches, reflecting films, etc.); The air conditioned room must remain closed for as long as possible; Avoid turning on halogen lamps or other high energy consumption appliances such as small ovens, steam irons, hot plates etc.).

6.2 Troubleshooting

For the user it is important to distinguish any malfunction or performance levels that differ from the system's standard operating values (see technical specifications). The most common problems can be easily solved by the user by performing certain simple tasks (see the Troubleshooting paragraph), while some system alarms require that you contact an Authorised Service Centre.

⚠ Please keep in mind that any attempt by unauthorised staff to repair the device automatically voids any form of warranty.

6.2.1 Functional aspects not to be interpreted as faults

- The compressor restarts 3 minutes after the last stop. This delay protects the compressor from too frequent activations.
- During Heating operation, air output may be delayed a few minutes after compressor activation. This delay prevents the possible delivery of cold air by allowing the unit to run at capacity and deliver warm air into the room.

6.2.2 Open CP contact

If the CP contact is not closed, the device does not start and the CP alarm appears on the display.

6.3 Maximum condensate collection level warning

In heating operation, condensate drains free through the appropriate pipe.

In case of an OF alarm, check that the condensation drain line is not bent or obstructed to prevent water from draining out.

In cooling or dehumidification function, in extreme operating condition (high temperature and high humidity) the unit may not be able to automatically dispose of the produced condensate, in this case the display will show OF.

The OF sign, is not an error, but an alarm indicating that the water has reached the maximum level of the condensate drip tray.

In this case, it is necessary to drain the condensate manually:

- ▶ place a drip pan (not provided) below the condensate drain pipe
- ▶ drain the water using the cap on the condensate drain pipe

- ⚠ If after performing the procedure, the OF alarm remains, you should contact the Technical Service Center.

6.4 Use of the appliance

- ⚠ Objects or structural obstacles (furniture, curtains, plants, leaves, blinds, etc.) must not obstruct the normal air flow both from the internal and from the external grids.
- ⚠ Do not lean against, or worse sit on, the body of the conditioner, this would damage the appliance.
- ⚠ Do not move the horizontal air outlet flap manually. Always use the remote control to perform such operation.
- ⚠ In the event of water leaks, turn off the appliance and disconnect the electric power supply. Call the nearest service centre.
- ⚠ During heating mode, the conditioner eliminates periodically any ice formed on the external battery. In such situation, the machine keeps on working, but it does not dispense warm air to the room. This phase can last from 3 up to maximum 10 minutes.
- ⚠ The appliance must not be installed in rooms where explosive gases develop or where there are humidity and temperature conditions that exceed the maximum levels reported on the installation manual.
- ⚠ Clean the air filter regularly as described in the specific paragraph.

7. TECHNICAL INFORMATION

7.1 Operating limits

Operating limits

	u.d.m.	Heating	Cooling
Minimum room relative humidity	%	15	15
Maximum room relative humidity	%	80	80
Minimum room air temperature	°C	-10	-10
Maximum room air temperature	°C	50	50

7.2 RED Compliance Statement

Compliance with 2014/53/EU Radio Equipment Directive (RED).

In accordance with Article 10.8(a) and 10.8(b) of the RED, the following table provides information on the frequency

Frequency range (MHz)	Max. Transmit Power
2400-2472	<20

Hereby, the company declares that the device is in compliance with Directive 2014/53/EU.

⚠ For declarations of conformity, certificates and other certification details please consult the website.

bands used and the maximum RF transmit power of the product for sale in the EU:

This equipment should be installed and operated with a minimum distance of 20 centimeters between the radiator and your body.

7.3 Safety

This equipment is designed with the utmost care for the safety of those who install and use it. However, special attention must be paid to the dangers of electric shock and static electricity when working with electrical equipment.

All guidelines must therefore be allowed at all times to ensure safe use of the equipment.

7.4 FCC Declaration of Conformity

This equipment complies with FCC radiation exposure limits set forth for an uncontrolled environment. To avoid the possibility of exceeding the exposure limits, maintain a distance of not less than 0.5 cm between the antenna and the person during normal operation.

⚠ This equipment complies with the limits for a Class B digital device, pursuant to FCC Rules.

⚠ The limits are designed to provide reasonable protection against harmful interference in a residential installation.

7.4.1 Warnings

⚠ This wireless device uses and can radiate radio frequency energy and, if not installed and used in accordance with the instructions, may cause harmful interference to radio communications.

⚠ This device must not be placed or used in conjunction with any other antenna or transmitter.

7.4.2 Notes on Wi-Fi communication

This equipment complies with the limits for a Class B digital device, pursuant to FCC Rules.

In case of interference:

- increase the distance between the object and the receiver
- immediately contact an Authorised Service Centre or suitably qualified personnel

EU countries intended for use

The version of this device is intended for home and business use in Austria, Belgium, Bulgaria, Cyprus, Czech Republic, Denmark, Estonia, Finland, France, Germany, Greece, Hungary, Ireland, Italy, Latvia, Lithuania, Luxembourg, Malta, the Netherlands, Poland, Portugal, Romania, Slovakia, Slovenia, Spain, Sweden, Turkey and the United Kingdom and is also authorised in the EFTA Member States: Iceland, Liechtenstein, Norway and Switzerland.

EU countries not intended for use

None.

Panasonic®

Panasonic Corporation
1006 Kadoma, Kadoma City, Osaka, Japan