

# ACCESSORIES



# ACCESSORIES

## QUICK GUIDE

### PRODUCTS SUITABILITY

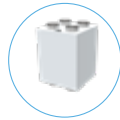

SILENCER

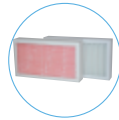

FILTERS



WATER HEATING COILS



PRE/AFTER HEATERS



HCV



RCV



HCC



HCH



# ACCESSORIES

## QUICK GUIDE

### PRODUCTS SUITABILITY

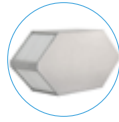

ENTHALPY HEAT EXCHANGERS



PLUGS AND CABLES



INSTALLATION ACCESSORIES



DISPLAY KITS



HCV



RCV



HCC



HCH



# ACCESSORIES

## SILENCER

The HCV 400-460 Silencer Box reduces fan and air flow noise before it is carried into the duct system. It is made of Aluzinc painted in colour RAL 9016. The ends of the sound attenuators are fitted with coupling connections and can be mounted directly on top of the HCV 400 or HCV 460 residential ventilation units.

Illustration	Accessory	Description	HCV 300	HCV 400	HCV 460	HCV 500	HCV 700	HCH 5	HCH 8	RCV 320	HCC 2	HCC 260 P1	HCC 360 E1
	096978	<b>Silencer Box</b> The HCV 400-460 Silencer Box reduces fan and air flow noise before it is carried into the duct system.		•	•								



HCV 400 with Silencer Box

### Key features

- Discreet design with same width, depth and colour as HCV 400 unit
- Significant sound attenuation is achieved on all four ducts
- Plug-and-Play solution that fits direct to the top of the HCV 400 unit
- All four ducts in the Silencer Box are thermally and acoustically insulated and prepared for HCV 400 left and right configuration of duct work to reduce installation time
- Easy cabling at the top of the HCV 400 unit, because the front lid of the silencer can be removed
- Pressure loss is negligible
- Includes circular sound attenuators made of perforated aluminium surrounded with glass wool insulation and a PE vapour barrier

### DIMENSIONS

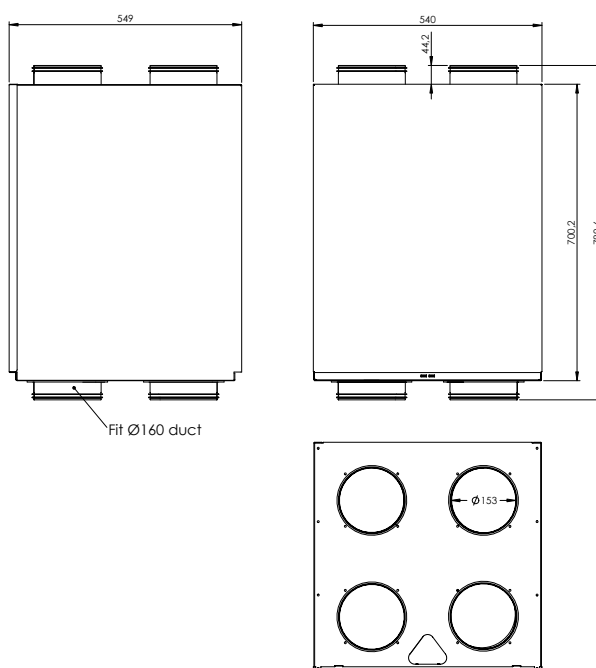

# ACCESSORIES

## SILENCER

The HCV 400-460 Silencer Box significantly reduces fan and air flow noise. The tables below illustrate the sound data with the Silencer Box installed, and can be compared with the sound data tables of the respective products in the wall-mounted units section of this catalogue.

### HCV 400<sub>P1</sub> SOUND DATA WITH G4/G4 FILTERS AND SILENCER BOX

Air flow	Pressure	Operational point	Sound effect Lw for centre frequency (1/1 octave)								Total sound power Lw(A)	Sound pressure 1m distance L <sub>p</sub> (A)	Sound pressure 2m distance L <sub>p</sub> (A)
			63Hz	125Hz	250Hz	500Hz	1000Hz	2000Hz	4000Hz	8000Hz			
m <sup>3</sup> /h	Pa		dB								dB(A)		
130	70	Supply	18.3	31.4	33.4	29.5	17.8	12.1	13.7	4.8	36.7		
		Extract	33.8	35.1	33.1	30.1	21.6	17.6	17.0	9.1	39.5		
		Outdoor	33.8	35.1	33.1	30.1	21.6	17.6	17.0	9.1	39.5		
		Exhaust	18.3	31.4	33.4	29.5	17.8	12.1	13.7	4.8	36.7		
		Cabinet										36.2	35.2
150	70	Supply	20.3	32.4	35.4	31.5	18.8	13.1	15.7	6.8	38.4		
		Extract	34.8	35.1	38.1	32.1	22.6	18.6	18.0	10.1	41.7		
		Outdoor	34.8	35.1	38.1	32.1	22.6	18.6	18.0	10.1	41.7		
		Exhaust	20.3	32.4	35.4	31.5	18.8	13.1	15.7	6.8	38.4		
		Cabinet										38.1	36.2
150	100	Supply	21.3	34.4	36.4	32.5	21.8	16.1	19.7	10.8	39.7		
		Extract	37.8	37.1	39.1	34.1	25.6	21.6	23.0	16.1	43.5		
		Outdoor	37.8	37.1	39.1	34.1	25.6	21.6	23.0	16.1	43.5		
		Exhaust	21.3	34.4	36.4	32.5	21.8	16.1	19.7	10.8	39.7		
		Cabinet										41.1	38.1
225	70	Supply	23.3	35.4	35.4	33.5	23.8	17.1	21.7	12.8	39.9		
		Extract	37.8	38.1	39.1	34.1	26.6	22.6	24.0	18.1	43.8		
		Outdoor	37.8	38.1	39.1	34.1	26.6	22.6	24.0	18.1	43.8		
		Exhaust	23.3	35.4	35.4	33.5	23.8	17.1	21.7	12.8	39.9		
		Cabinet										41.8	39.3
225	100	Supply	26.3	39.4	40.4	35.5	25.8	20.1	23.7	15.8	43.9		
		Extract	39.8	41.1	44.1	37.1	29.6	24.6	27.0	22.1	47.4		
		Outdoor	39.8	41.1	44.1	37.1	29.6	24.6	27.0	22.1	47.4		
		Exhaust	26.3	39.4	40.4	35.5	25.8	20.1	23.7	15.8	43.9		
		Cabinet										43.5	41.2
300	100	Supply	28.3	40.4	39.4	40.5	29.8	23.1	27.7	19.8	45.2		
		Extract	42.8	43.1	44.1	41.1	32.6	28.6	31.0	27.1	49.2		
		Outdoor	42.8	43.1	44.1	41.1	32.6	28.6	31.0	27.1	49.2		
		Exhaust	28.3	40.4	39.4	40.5	29.8	23.1	27.7	19.8	45.2		
												46.5	44.5

# ACCESSORIES

## SILENCER

### HCV 400<sub>P2</sub> SOUND DATA WITH G4/G4 FILTERS AND SILENCER BOX

Air flow	Pressure	Operational point	Sound effect Lw for centre frequency (1/1 octave)								Total sound power Lw(A)	Sound pressure 1m distance	Sound pressure 2m distance
			63Hz	125Hz	250Hz	500Hz	1000Hz	2000Hz	4000Hz	8000Hz			
m <sup>3</sup> /h	Pa		dB								dB(A)		
100	80	Supply	19.4	36.7	25.0	21.6	11.7	4.8	17.6	8.5	37.2		
		Extract	32.9	39.1	24.6	25.7	13.7	9.4	18.2	16.5	40.4		
		Outdoor	32.9	39.1	24.6	25.7	13.7	9.4	18.2	16.5	40.4		
		Exhaust	19.4	36.7	25.0	21.6	11.7	4.8	17.6	8.5	37.2		
		Cabinet										33.4	31.2
150	100	Supply	27.6	37.3	38.0	32.0	21.3	14.0	18.7	16.5	41.5		
		Extract	40.5	41.3	38.0	36.3	23.0	15.9	19.2	16.5	45.5		
		Outdoor	40.5	41.3	38.0	36.3	23.0	15.9	19.2	16.5	45.5		
		Exhaust	27.6	37.3	38.0	32.0	21.3	14.0	18.7	16.5	41.5		
		Cabinet										40.9	38.3
240	200	Supply	34.0	40.2	47.9	41.8	30.4	22.1	21.2	19.8			
		Extract	47.0	46.9	47.2	44.1	32.5	24.5	24.9	21.0			
		Outdoor	47.0	46.9	47.2	44.1	32.5	24.5	24.9	21.0			
		Exhaust	34.0	40.2	47.9	41.8	30.4	22.1	21.2	19.8			
		Cabinet											

### HCV 400<sub>E1</sub> SOUND DATA WITH G4/G4 FILTERS AND SILENCER BOX

Air flow	Pressure	Operational point	Sound effect Lw for centre frequency (1/1 octave)								Total sound power Lw(A)	Sound pressure 1m distance	Sound pressure 2m distance
			63Hz	125Hz	250Hz	500Hz	1000Hz	2000Hz	4000Hz	8000Hz			
m <sup>3</sup> /h	Pa		dB								dB(A)		
100	80	Supply	17.0	36.2	33.7	26.5	16.9	10.0	16.1	0.0	38.5		
		Extract	35.9	37.3	30.9	30.0	19.7	16.0	16.6	7.9	40.7		
		Outdoor	35.9	37.3	30.9	30.0	19.7	16.0	16.6	7.9	40.7		
		Exhaust	17.0	36.2	33.7	26.5	16.9	10.0	16.1	0.0	38.5		
		Cabinet										33.7	32.8
150	100	Supply	21.8	35.9	39.0	30.5	21.5	13.9	18.3	11.7	41.2		
		Extract	38.8	39.5	42.3	35.9	23.0	17.1	18.7	11.6	45.8		
		Outdoor	38.8	39.5	42.3	35.9	23.0	17.1	18.7	11.6	45.8		
		Exhaust	21.8	35.9	39.0	30.5	21.5	13.9	18.3	11.7	41.2		
		Cabinet										40.7	39
240	200	Supply	30.2	39.0	41.6	39.4	28.9	20.5	20.6	20.7	45.2		
		Extract	41.8	43.5	47.1	41.5	31.0	23.9	22.7	22.8	50.2		
		Outdoor	41.8	43.5	47.1	41.5	31.0	23.9	22.7	22.8	50.2		
		Exhaust	30.2	39.0	41.6	39.4	28.9	20.5	20.6	20.7	45.2		
		Cabinet										48.6	46.5



# ACCESSORIES FILTERS

BUY ONLINE  
shop.dantherm.com



Most models use 50mm **G4 cartridge** filters as standard for both supply air and extract air. This will cater to the majority of air cleaning needs. The advantage of compact filters is that they have a considerably larger filter surface area than fibrous filters and small bag filters. The filter thus works for longer and under normal conditions it will not need changing more often than twice a year, equivalent to the filter timer setting.

**F7 filters (pollen filters):** If necessary, F7 filters are available as accessories, which ensure that allergens do not enter the home through the ventilation system.











All filters are available to buy online, including those for out-phased units.

Illustration	Accessory	Description	HCV 300	HCV 400	HCV 460	HCV 500	HCV 700	HCH 5	HCH 8	RCV 320	HCC 2	HCC 260P1	HCC 360E1	HCC 360P2
	093844	<b>HCV 300 – Panel filter set, F7/G4</b> One F7 filter and one G4 filter.	•											
	093845	<b>HCV 300 – Panel filter set, G4</b> Two G4 filters.	•											
	098346	<b>HCV 400 – Panel filter set, F7/G4</b> One F7 filter and one G4 filter.		•	•									
	098347	<b>HCV 400 – Panel filter set, G4</b> Two G4 filters.		•	•									
	096393	<b>HCV 500 – Panel filter set, F7/G4</b> One F7 filter and one G4 filter.				•								
	087342	<b>HCV 500 – Panel filter set, G4</b> Two G4 filters.				•								
	093479	<b>HCV 700 – Panel filter set, F7/G4</b> One F7 filter and one G4 filter.					•							
	093478	<b>HCV 700 – Panel filter set, G4</b> Two G4 filters.					•							
	063448	<b>HCH 5 – Panel filter set, F7/G4</b> One F7 filter and one G4 filter.						•						
	063470	<b>HCH 5 – Panel filter set, G4</b> Two G4 filters.						•						
	063449	<b>HCH 8 – Panel filter set, F7/G4</b> One F7 filter and one G4 filter.							•					
	063471	<b>HCH 8 – Panel filter set, G4</b> Two G4 filters.							•					
	087998	<b>HCC 2 – Panel filter set, F7/G4</b> One F7 filter and one G4 filter.									•	•	•	•
	087997	<b>HCC 2 – Panel filter set, G4</b> Two G4 filters.									•	•	•	•
	111174	<b>RCV 320 – Panel filter set, G4</b> Two G4 filters.								•				
	111175	<b>RCV 320 – Panel filter set, F7/G4</b> One F7 filter and one G4 filter.								•				

ACCESSORIES

# PRE/AFTER WATER HEATING COILS

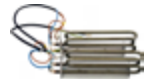
Pre- and after-heating coils are effective solutions to regulate the air temperature, with preheating coils an excellent choice for preventing ice building up in the heat exchanger at low temperatures, and post-heating coils effective at increasing the supply air temperature.

Illustration	Accessory	Description	HCV 300	HCV 400	HCV 460	HCV 500	HCV 700	HCH 5	HCH 8	RCV 320 P2	HCC 2	HCC 260 P1	HCC 360 E1	HCC 360P2
	063843	<b>Water heating coil set, Ø125mm</b> The set includes water heating coils with 2RR, two-way water valve, 0-10V servo motor, 230/24V VAC trafo, duct sensor and tube sensor for frost protection. To be controlled by the accessory control HAC.	•							•	•	•	•	•
 Servo motor	063851	<b>Water heating coil set, Ø160mm</b> The set includes water heating coils with 2RR, two-way water valve, 0-10V servo motor, 230/24V VAC trafo, duct sensor and tube sensor for frost protection. To be controlled by the accessory control HAC.		•	•	•		•		•	•	•	•	•
 Two-way water valve	063852	<b>Water heating coil set, Ø250mm</b> The set includes water heating coils with 2RR, two-way water valve, 0-10V servo motor, 230/24V VAC trafo, duct sensor and tube sensor for frost protection. To be controlled by the accessory control HAC.					•		•					
 230/24 V VAC trafo														
	076107	<b>Preheating coil, 700W</b> For building into the unit.	•											
	098268	<b>Preheating coil, 1400W</b> For building into the unit.		•										
	108639	<b>Preheating coil, 1850W</b> For building into the unit.			•									
	115124	<b>Preheating coil, 1400W</b> For building into the unit.				•		•						
	076108	<b>Preheating coil, 2 x 600W</b> For building into the unit.				•								
	076109	<b>Preheating coil, 2 x 800W</b> For building into the unit.					•							
	110459	<b>Preheating coil, 1 x 900W</b> For building into the unit.								•				



# PRE/AFTER WATER HEATING COILS FEATURES



## Water heating coils

The water heating coil kit includes 2RR, 2-way water valve, 0-10V servo motor, 230/24VAC trafo, duct sensor and tube sensor for frost protection. It is controlled by the accessory control HAC 2.

CWW 125-2-2.5		Max capacity						Supply air temperature 21°C					
		80°C/60°C			60°C/40°C			80°C/60°C			60°C/40°C		
Air volume	m³/h	85	150	215	85	150	215	85	150	215	85	150	215
Air temperature out	°C	40	36	34	28	25	23	21	21	21	21	21	21
Pressure loss	Pa	11	28	51	11	28	51	11	28	51	11	28	51
Capacity	kW	0.7	1.1	1.4	0.4	0.5	0.6	0.2	0.3	0.5	0.2	0.3	0.5
Water flow	L/h	36	36	72	36	36	36	9	10	23	17	22	28
Pressure loss, max.	KPa	0.5	0.5	1	0.5	0.5	0.5	0.2	0.2	0.4	0.3	0.4	0.5

CWW 160-2-2.5**		Max capacity						Supply air temperature 21°C					
		80°C/60°C			60°C/40°C			80°C/60°C			60°C/40°C		
Air volume	m³/h	145	250	335	145	250	335	145	250	335	145	250	335
Air temperature out	°C	47	43	40	33	31	29	21	21	21	21	21	21
Pressure loss	Pa	6	15	27	6	15	27	6	15	27	6	15	27
Capacity	kW	1.6	2.4	3.0	0.9	1.3	1.7	0.3	0.5	0.7	0.3	0.5	0.7
Water flow	L/h	72	108	144	36	72	72	14	24	35	12	28	30
Pressure loss, max.	KPa	1	3	4	0.5	1	2	0.2	0.4	0.5	0.1	0.4	0.5

CWW 250-2-2.5***		Max capacity						Supply air temperature 21°C			
		80°C/60°C		60°C/40°C		80°C/60°C		60°C/40°C			
Air volume	m³/h	360	630	630	360	360	630	360	630		
Air temperature out	°C	44	40	31	29	21	21	21	21		
Pressure loss	Pa	10	25	10	25	10	25	10	25		
Capacity	kW	3.6	5.3	2.0	3.0	0.74	1.29	0.74	1.28		
Water flow	L/h	72144	252	108	144	30	61	40	61		
Pressure loss, max.	KPa	1	3	1	2	0.5	1.0	0.7	1.0		

\*Air in 15°C.

\*\* Please note that this heater coil has 160mm duct connections, so 2 pcs of Ø160/200mm duct reduction parts are needed for installation with a HCV 700 (Ø200).

\*\*\* Please note that this heater coil has 250mm duct connections, so 2 pcs of Ø200/250mm duct reduction parts are needed for installation with a HCV 700 (Ø200).

# PRE/AFTER WATER HEATING COILS FEATURES

## WEIGHT





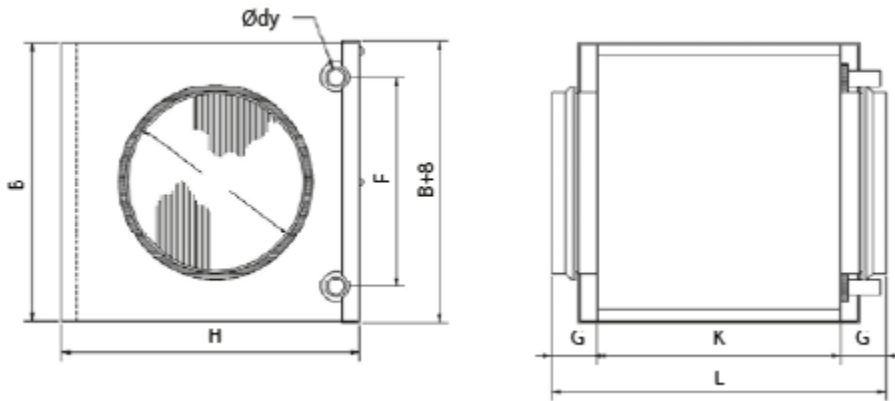

	Ød	B	H	Ødy	F	G	K	L	Weight
	mm								
CWW 125-2-2.5	125	238	180	10	137	40	276	356	3.5
CWW 160-2-2.5	160	313	255	10	212	40	276	356	5.4
CWW 250-2-2.5	250	398	330	10	250	40	276	356	7.7

## DIMENSIONS



ACCESSORIES

# PRE/AFTER HEATERS

Illustration	Accessory	Description	HCV 300	HCV 400	HCV 460	HCV 500	HCV 700	HCH 5	HCH 8	RCV 320 P1	HCC 2	HCC 260 P1	HCC 360
	063853	<b>Electric pre-/after heating coil, Ø125mm, 900W stand-alone</b> The set includes a 900W electric heater with duct sensor and built-in thermostat control. Direct control by the built-in thermostat, with no connection to the ventilation unit.	▼							▼	▼	▼	▼
	063854	<b>Electric pre-/after heating coil, Ø160mm, 1200W stand-alone</b> The set includes a 1200W electric heater with duct sensor and built-in thermostat control. Direct control by the built-in thermostat, with no connection to the ventilation unit.		▼		▼	▼	●					
	063855	<b>Electric pre-/after heating coil, Ø250mm, 1800W stand-alone</b> The set includes a 1800W electric heater with duct sensor and built-in thermostat control. Direct control by the built-in thermostat, with no connection to the ventilation unit.					▼		●				
	063898	<b>Electrical pre-/after heater kit, Ø125mm, 900W, 0-10V controlled</b> The set includes a 900W heater, integrated 0-10V regulation and a duct sensor. Must be controlled from the accessory control HAC.	▼							▼			
	063899	<b>Electrical pre-/after heater kit, Ø160mm, 1200W, 0-10V controlled</b> The set includes a 1200W heater, integrated 0-10V regulation and a duct sensor. Must be controlled from the accessory control HAC.		▼	▼	▼	▼	●					
	063900	<b>Electrical pre-/after heater kit, Ø250mm, 1800W, 0-10V controlled</b> The set includes a 1800W heater, integrated 0-10V regulation and a duct sensor. Must be controlled from the accessory control HAC.					▼		●				
	086877	<b>External electric preheating coil, 900W</b> The set includes a 900W heater and a power cable. The heater is controlled and powered by the main PCB of the HCC unit.									●	●	●
		<b>External electric preheating coil, 1200W</b> The set includes a 1200W heater and a power cable. The heater is controlled and powered by the main PCB of the unit.								●			

▼ Only used for after heating.

# PRE/AFTER HEATERS FEATURES



### Circular electric duct heater for reheating of supply air

The electric duct heater is designed for installation in the supply air duct. The duct heater is provided with duct connections with a rubber sealing gasket. The duct heater is not suitable for outdoor installation. The control current is connected to the accessory control HAC 2. Connection to supply voltage 230V is made separately. The duct heater is controlled by a stepless regulation via the accessory control HAC 2.

### Circular electric duct heater, direct control by the built-in thermostat

This duct heater is controlled by the built-in thermostat. Both heaters are supplied with a duct sensor.

### Capacity, dimensions and weight

The duct heaters are without fins and therefore the resulting air pressure loss is negligible.

Specifications	Units	063853	063854	063855
Air volume	m <sup>3</sup> /h	180	300	450
Heat output	kW	0.9	1.2	1.8
Temperature rise	°C	16.8	14.2	3.4
Power consumption, 1 x 230V	A	4.1	5.5	8.2
Duct connection	Ø mm	125	160	250
Weight	kg	3.0	3.5	5.0

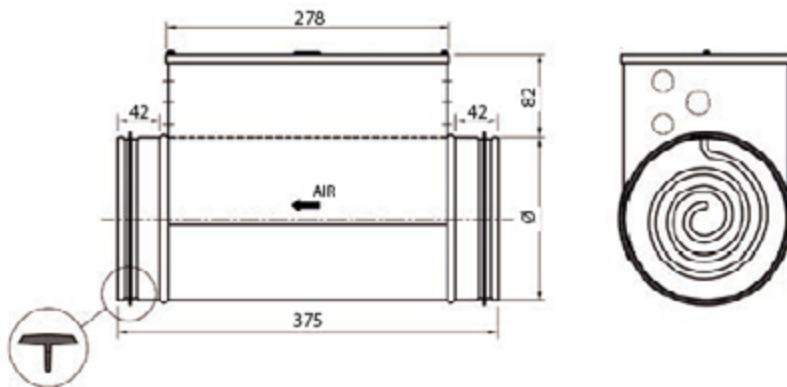

## DIMENSIONS



## ACCESSORIES

# ENTHALPY HEAT EXCHANGERS











Heat recovery takes place in a highly efficient counter-flow heat exchanger, which is able to achieve optimum efficiency with the least possible loss of pressure in connection with the low air volumes used in housing. Transferring the humidity from the extract air to the fresh supply air prevents a dry indoor climate during wintertime. In the summer, when the relative humidity of the outdoor air is high, supply air will be dehumidified when passing through the enthalpy exchanger. This makes the supply air feel comfortably cold. Because of their superb ability to recover both heat and humidity, enthalpy exchangers are known to reduce heating costs substantially.

Illustration	Accessory	Description	HCV 300	HCV 400 P1-P2	HCV 460P2	HCV 500	HCV 700	HCH 5	HCH 8	RCV 320	HCC 2	HCC 260P1	HCC 360P2
	099183	<b>Enthalpy heat exchanger</b> For SWOP solution. Separate box including installation, labelling, flow chart etc.		•	•					•			
	099229	<b>Enthalpy heat exchanger</b> For SWOP solution. Separate box including installation, labelling, flow chart etc.									•	•	•

When the heat exchanger has been swapped, you need to use the PC Tool to change the unit type to the right enthalpy variant (E1). To ensure correct air balance, you will subsequently have to recalibrate the unit.











# ACCESSORIES

## PLUGS AND CABLES

Illustration	Accessory	Description	HCV 300	HCV 400	HCV 460	HCV 500	HCV 700	HCH 5	HCH 8	RCV 320	HCC 2	HCC 260 P1	HCC 360
	087353	<b>Condensate pump kit</b> This condensate pump kit is designed for mounting on HCC 2 units where there is no safe drain with fall to a drainage or on units where the drain is too far away. The kit is furnished with a bracket for fixing it to the HCC 2 unit, a power supply cable for connection to the HCC 2 unit, pressure equalisation hose and drain hose.									•		
	108625	<b>Condensate pump kit</b> This condensate pump kit is designed for mounting on HCC 260 and HCC 360 units where there is no safe drain with fall to a drainage or on units where the drain is too far away.										•	•
	064885	<b>Power supply, 230VAC - 24VDC for duct control</b> The 24VDC power supply is used together with HAC if the ventilation unit is controlling duct damper motors.	•	•	•	•	•	•	•	•	•	•	•
	086861	<b>Digital plug, 25 pcs</b> This digital plug is connected to the control of the unit. This allows to override the following fan speed, fire/smoke/negative pressure/stop+alarm and high water level stop.	•	•	•	•	•			•	•	•	•
	087619	<b>USB cable, 3m</b> USB cable to be used in connection with software update of units and Dantherm PC Tool (HPT 1).	•	•	•	•	•			•	•	•	•
	099104	<b>Cable for HCP 11, 20m</b> Extension cable for the wired HCP 11 control.	•	•	•	•	•			•	•	•	•
	086853	<b>Calibration set, 10 pcs</b> Calibration set for air flow calibration. Including 3m silicone tube, suction cups and fittings.	•	•	•	•	•			•	•	•	•
	062737	<b>Siphon trap kit</b> Including 2m 3/4" hose.						•	•				
	064807	<b>Heat cable, 3m</b> 230V, 10W/m including 5°C thermostat. For frost protection of condensate hose.						•	•				
	063887	<b>Communication cable, 30m</b> Cable with plug for connection of control panel to the HCH unit.						•	•				
	096427	<b>Communication cable, 10m</b> Cable with plug for connection of control panel to the HCH unit.						•	•				





# INSTALLATION ACCESSORIES

Illustration	Accessory	Description	HCV 300	HCV 400	HCV 460	HCV 500	HCV 700	HCH 5	HCH 8	RCV 320	HCC 2	HCC 260 P1	HCC 360
	053730	<b>Floor stand</b> Height 230mm and adjustable feet. RAL 9016 Traffic white.	•										
	099220	<b>Floor stand</b> Height 120mm and adjustable feet. RAL 9016 Traffic white.		•	•					•			
		<b>Floor stand</b> Alu-zink.		•	•					•			
	052423	<b>Floor stand</b> Height 230mm and adjustable feet. RAL 9016 Traffic white.				•	•						
	098251	<b>Mounting attrap, 2 sets</b> To indicate the mounting dimensions in advance, without using the real unit. Includes 2 x mounting attrap + 2 x wall rails.		•	•								
	098426	<b>Mounting attrap</b> To indicate the mounting dimensions in advance, without using the real unit. Includes 2 x mounting attrap + 2 x wall rails.	•										
	052250	<b>Inspection door</b> <b>730 x 1200mm</b> Mat white RAL 9016 with key.									•	•	•
	052251	<b>Inspection door with sound insulation</b> <b>730 x 1200mm</b> Mat white RAL 9016 with key.									•	•	•
	052252	<b>Inspection door</b> <b>730 x 1500mm</b> Mat white RAL 9016 with key.									•	•	•
	052254	<b>Inspection door with sound insulation</b> <b>730 x 1500mm</b> Mat white RAL 9016 with key.									•	•	•
	111176	<b>Oval duct adaptor</b> PE-HD adaptor to connect an oval duct. The integrated lip seal provides an airtight connection between the pipe and the adaptor. The oval duct adaptor is suitable for supply air.								•			

# ACCESSORIES

## DISPLAY KITS

Illustration	Accessory	Description	HCV 300	HCV 400	HCV 460	HCV 500	HCV 700	HCH 5	HCH 8	RCV 320	HCC 2	HCC 260 P1	HCC 360
	051958	<b>Display kit</b> Kit including polycarbonate and mounting parts, flow chart and instructions.		•	•								
	051956	<b>Display kit</b> Kit including polycarbonate and mounting parts, flow chart and instructions.									•	•	•
	111173	<b>Display kit</b> Kit including polycarbonate and mounting parts, flow chart and instructions.							•				

# CONTROLS



# CONTROLS

## CONTROLS RANGE

### QUICK GUIDE

#### PRODUCTS SUITABILITY



EMBEDDED CONTROL



FOIL PANEL



WIRELESS CONTROL



WIRED CONTROL



PC TOOL



MOBILE APP



HCV



RCV



HCC



HCH



# CONTROLS PLATFORM SET UP

## PLATFORM 2:

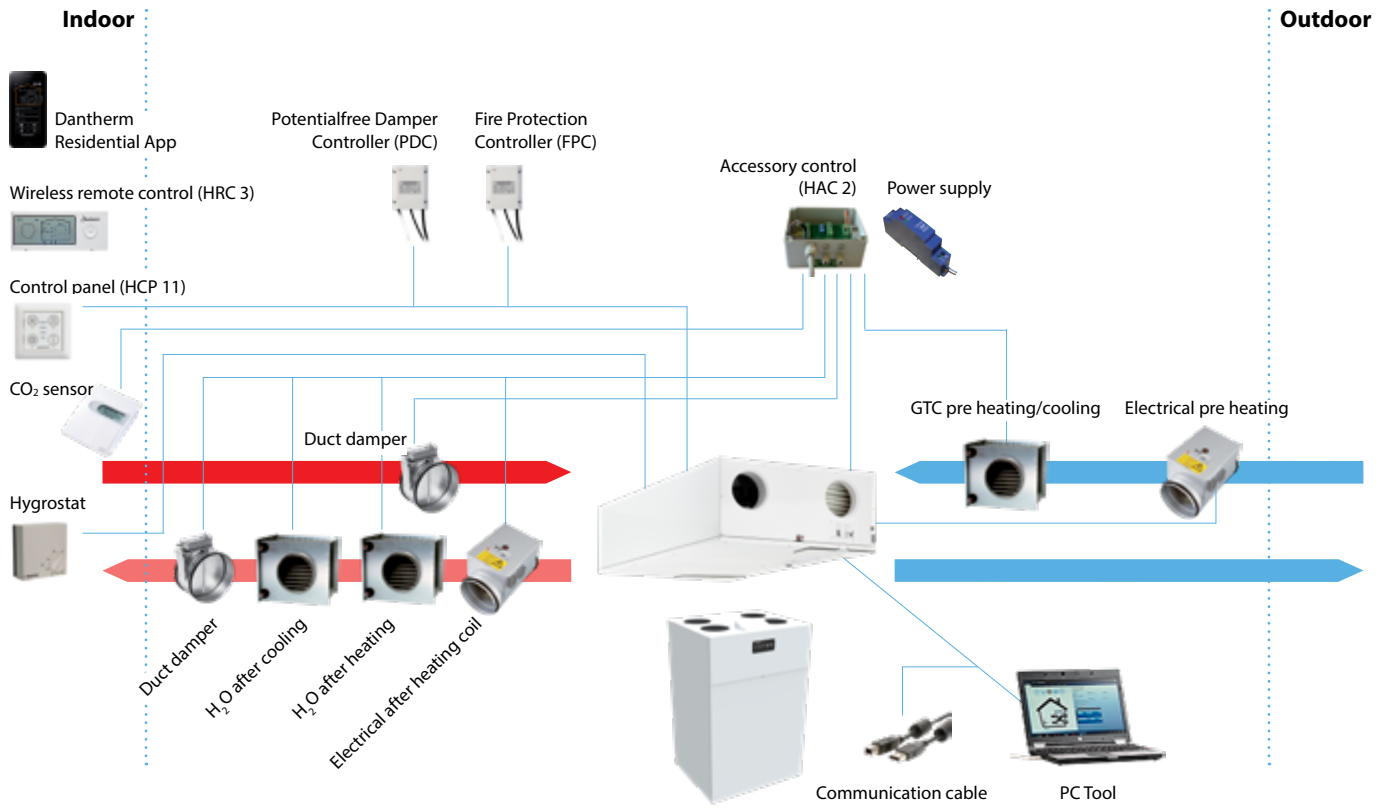

## CONTROLS RANGE

# EMBEDDED CONTROLS

HCV and HCC units have an embedded control which measures and adjusts all parameters continuously in order to maintain a correct ventilation level at the lowest possible energy consumption. The controller has a wide range of connections for both internal and external accessories.



Platform 2

The controller has a wide range of connections for both internal and external accessories.

For external connections, you will find:

- Wired LAN interface that supplies data communication to ModBus over TCP/IP
- Ideal for connection to external building management systems (BMS/CTS)
- ModBus over RS485: For HAC accessory control or wired control (HCP 11)
- Antenna socket for the wireless remote control antenna
- Two additional digital inputs that can be used for e.g. forced operation controlled by the hygrostat, cooker hood, fire protection or similarly

For more on internal accessories, please see the “Accessories” chapter.

The USB connection of the controller enables professional installers to carry out all adjustments and settings using the Dantherm PC Tool. The PC Tool is also capable of displaying both live and historic data for all unit components. This is crucially important in connection with maintenance, service and troubleshooting.

The USB port offers firmware update option.

The HCV units are secured against incorrect and uneconomical operation for long periods of time. Several of the functions return to default after four hours as a means of preventing excessive energy consumption, for instance if a unit is left running at maximum fan speed or in manual bypass mode. If you switch off the installation, it will automatically restart after four hours to ensure proper ventilation and to keep condensation from forming in the ducts and in the unit.

In emergency situations where there is a warning message about switching off ventilation systems and closing doors and windows, the supply current to the system must be interrupted by a safety switch or similarly.



# CONTROLS RANGE

## EMBEDDED CONTROLS

### Control panel

The HCV unit has a built-in control panel with four buttons for controls, and nine LED feedback signals.

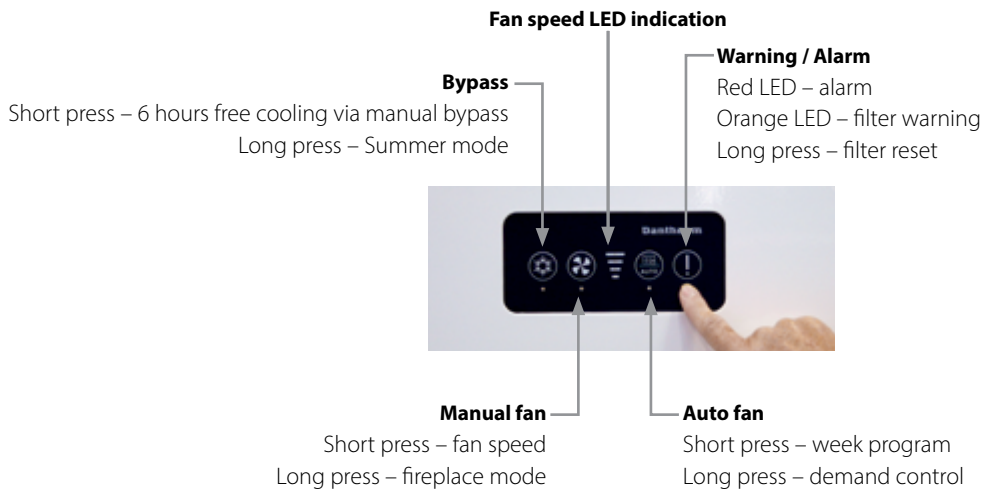

### Fan control

During initial calibration, fan speed no. 3 is set on the control panel to the nominal air volume the house requires under normal usage.

The correlation between the four fan speeds on the control panel is as follows:

- Fan speed 0 = both fans stopped for 4 hours
- Fan speed 1 = 30% lower than fan speed 2
- Fan speed 2 = 30% lower than fan speed 3
- Fan speed 3 = nominal air change, set by installer during the initial calibration
- Fan speed 4 = 30% higher than fan speed 3 (4-hour time-out)

In demand-controlled mode with integrated humidity sensor, the maximum speed is step 3.

In demand-controlled mode with integrated VOC sensor or CO<sub>2</sub> sensor connected to the HAC 2, the maximum speed is step 4.

### Filter control

The filter pressure is expected to increase between filter change intervals. To compensate for the reduced air volumes over time, the two fans run faster and faster until the filter alarm is triggered and the filter timer has been reset.

# CONTROLS RANGE

## WIRELESS REMOTE CONTROL

We offer a wireless remote control option, which can be mounted on the wall or placed on a shelf. The remote control is designed for the user, but also includes a special installer menu, allowing the installer to do extensive settings without the use of the PC Tool.

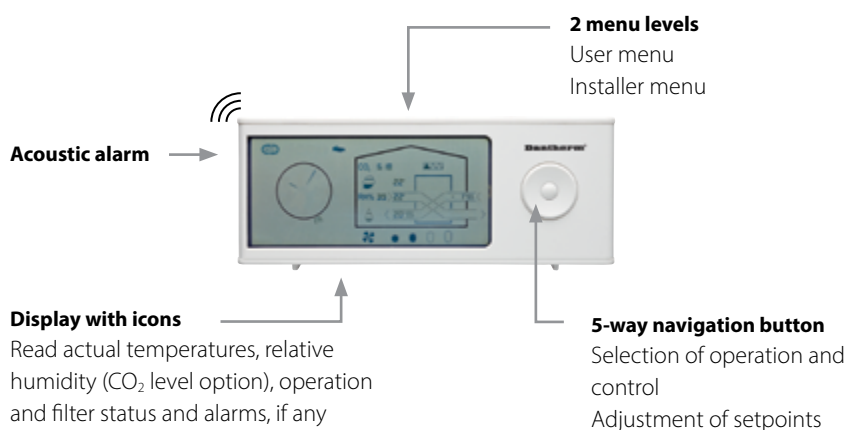

The user features are:

- Select fan speed in manual mode
- Select demand mode
- Select week mode, as well as selecting week program 1-11
- Manually activated by-pass
- Enable fireplace boost mode – seven minutes with overpressure inside the house for easy ignition of a fireplace
- Enable/disable away mode – the unit decreases permanently to fan speed 1
- Enable/disable night mode – the unit decreases to fan speed 1. The hour for enable/disable can be adjusted.
- Adjust filter timer duration
- Reset filter timer after filter exchange
- Reading air temperatures in the duct connections, including the remote controls embedded temperature sensor
- Setting time and date

The remote control has a visual/acoustic alarm that will sound when the filter needs to be inspected or replaced. This ensures correct maintenance even when the unit is set to demand mode and your attention is not at the remote control.

The wireless remote control uses two AAA alkaline batteries. Battery lifetime of up to two years is possible, as the display and remote shifts to hibernation mode after two minutes without user interaction. In addition, the remote is shut down at night.

Illustration	Code	Description	HCV 300	HCV 400	HCV 460	HCV 500	HCV 700	RCV 320	HCH 5	HCH 8	HCC 2	HCC 260 P1	HCC 360
	087953	<b>Wireless remote control, HRC 3</b> Remote control with manual operation, demand-controlled operation, week program, away operation, night operation, readings and installer menu.	•	•	•	•	•	•	•	•	•	•	•

# CONTROLS RANGE

## WIRED CONTROL

### Wired control (HCP)

This wired control comes with a white plastic frame and a metal frame for fastening into a standard junction box as well as a 6m communication cable. Alternatively, Dantherm can supply a box for fixing to the wall in an appropriate place.

The HCP 11 wired control gives the user the following possibilities :

- Manual control of air change (step 0-4)
- Control of air change with week program
- Demand controlled air change (when RH and VOC sensors are connected)
- Enable summer cooling mode (only extract air)
- Enable free cooling with bypass
- Enable fireplace mode
- Reading and resetting of alarms, including filter alarm

The installer can use the wired HCP 11 to adjust air volumes during commissioning.



Illustration	Code	Description	HCV 300	HCV 400	HCV 460	HCV 500	HCV 700	HCH 5	HCH 8	RCV 320	HCC 2	HCC 260 P1	HCC 360
	052539	<b>Wired control, HCP 11</b> With acoustic alarm. Fire protection control compatible. Wired control with manual control, week program, demand control, summer cooling mode, free cooling with bypass, fireplace mode as well as air flow settings. Including 6m cable.	•	•	•	•	•	•	•	•	•	•	•

# CONTROLS RANGE PC TOOL



**CALIBRATION VIA PC TOOL**



**CALIBRATION USING CONTROL PANEL**



**FILTER TIMER RESET**

The Dantherm PC Tool is available for all units. Though its installer menu, the installer can easily adjust the unit, connect extra accessories, adjust various user settings, read and reset alarms, if any.

It also has a user menu, where the user can read and adjust various settings, such as week programs, set points, alarms and historical data about temperatures and air quality (accessory).



# CONTROLS RANGE

## DANTHERM APP

The Dantherm App, which is available for iOS and Android via the App store and Google play, offers a user-friendly and intuitive way to control the residential ventilation unit. The App is connected to the Wi-Fi router of the house. It is available for all HCV and HCC units.

The control options include:

- Demand control operation
- Manual operation
- Week program operation
- Night operation
- Manual bypass cooling
- Summer cooling.
- Fireplace mode
- Alarms
- Settings menu





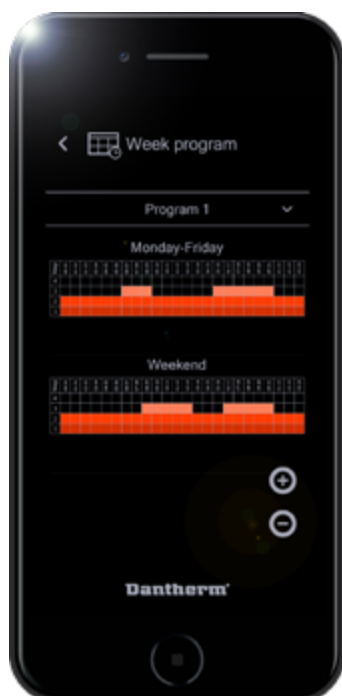







Easy to use! You can download it on Google Play or the App Store. Demo mode included.



CONTROLS ACCESSORIES

# CONTROL ACCESSORIES RANGE

A wide range of additional control accessories are available in order to cover any specific need for control and system optimisation.

Illustration	Accessory	Description	HCV 300	HCV 400	HCV 460	HCV 500	HCV 700	HCH 5	HCH 8	RCV 320	HCC 2	HCC 260 PT	HCC 360
	516301	<b>Hygrostat</b> The hygrostat measures the humidity in wet rooms. Ideal for high-humidity rooms requiring an increased air change, for instance bathrooms.	●	●	●	●	●	▼	▼	●	●	●	●
	113118-2	<b>Humidity sensor, 700mm</b> The RH% demand sensor will continuously monitor the humidity of the extract air and adjust the air flow level accordingly.									●	●	●
	111635-2	<b>Air quality sensor, 700mm</b> The VOC sensor will continuously monitor the level of artificial as well as natural organic fumes in the air and adjust the air flow level accordingly.									●	●	●
	113114-2	<b>Humidity sensor, 480mm</b> The RH% demand sensor will continuously monitor the humidity of the extract air and adjust the air flow level accordingly.	●	●	●	●	●	●	●	●			
	111633-2	<b>Air quality sensor, 480mm</b> The VOC sensor will continuously monitor the level of artificial as well as natural organic fumes in the air and adjust the air flow level accordingly.	●	●	●	●	●	●	●	●	●	●	●
	063874	<b>CO<sub>2</sub> sensor</b> For control of air change accordance with the CO <sub>2</sub> level in a given room.	●	●	●	●	●	●	●	●	●	●	●
	096984	<b>Antenna extender</b> 5m.		●	●								
	098084	<b>Potentialfree Damper Controller (PDC)</b> For potential free ON/OFF control of damper motor. Up to 4 PDC per ventilation unit.	●	●	●	●	●	●	●	●	●	●	●
	098083	<b>Fire Protection Controller (FPC)</b> For connection of fire and smoke damper or smoke damper. Up to 4 FPC per ventilation unit.	●	●	●	●	●	●	●	●	●	●	●
	077138	<b>Accessory control, HAC 2</b> For control of heating coils, geothermal pre-cooling/heating coils, duct dampers, stop function input, fire thermostat, CO <sub>2</sub> sensor, hygrostat and alarms. Including 3m cable.	●	●	●	●	●	●	●	●	●	●	●

▼ Unit needs a HAC 1 to connect the hygrostat.



## CONTROLS ACCESSORIES

# HAC AND SENSORS



Accessory control HAC 2

### Accessory control HAC 2

One or more of the following functions can be connected to the accessory control:

- After heating coils for water or electricity
- Geothermal preheating/pre-cooling coils
- 24 VDC duct damper outlet
- Stop function inlet
- Fire/smoke detector inlet
- External CO<sub>2</sub> sensor for demand control
- External hygrostat
- Filter alarm outlet
- General alarm

HAC 2 comes with 3m cable.



VOC air quality demand sensor

### VOC air quality demand sensors

The unit can be fitted with a VOC air quality sensor. This sensor will continuously monitor the level of artificial as well as natural organic fumes in the air.

Examples of included fumes:

- Natural fumes, e.g. formaldehyde from building materials
- Chemical fumes from sprays, e.g. hair spray or perfumes
- Indoor pollution e.g. from smoking and printing with laser printer
- Fumes from fire-retardant substances in carpets, paint and furniture

Using the VOC sensor in demand mode will result in the correct level of ventilation with the lowest possible power consumption. If a wireless remote control or App is connected, the actual VOC level will be shown in the display using a 3 level icon.



Humidity sensor

### Humidity RH% demand sensor

The ventilation units can be fitted with a humidity sensor (RH%). This sensor will continuously monitor the humidity of the extract air and adjust the air flow level in accordance with the demand of the home. Using demand mode will ensure the correct level of ventilation at the lowest possible electrical power consumption. The level of humidity is indicated in the Dantherm App as well as the wireless remote control (if connected). If VOC, CO<sub>2</sub> and RH% sensors have been fitted, the ventilation level will be determined by the sensor that detects the highest demand.

## CONTROLS ACCESSORIES

# FIRE PROTECTION CONTROLLER (FPC)

The Fire Protection Controller (FPC) is a unit that controls a fire damper for fire and smoke protection purposes. The unit has been designed for Belimo or similar fire damper actuators fitted with spring-return and position feedback. The fire damper actuator is connected directly to the FPC, and then controlled via the ventilation system. Each FPC is to be addressed individually. Up to four FPCs can be connected to one ventilation unit.

The FPC is fitted with LED lamps indicating the damper position and status, and a digital input socket for surveillance if so required in your installation, for instance for a thermostat or a smoke detector.



Fire Protection Controller (FPC)

### Features

- Easy cable installation
- Individual alarm and damper status
- Digital input for thermostat or smoke detector for surveillance where required
- LED lamps indicate damper position and status
- Weekly or monthly self-test

For decentralised ventilation applications, the most frequently used solution is to lead exhaust air from each apartment and to the roof through separate air ducts. The ducts are fireproofed and joined in one exhaust air cowl. Such a solution often requires more ventilation shaft space than available, particularly in connection with renovation projects. Instead, the exhaust air can be removed using one joint air duct. But that requires fire and smoke dampers, fire thermostats and external automatic fire protection. Until now, this has dramatically increased the price of renovation projects.

Keeping installation costs for projects with joint air ducts at a very competitive level, Dantherm's new residential ventilation units have been fully prepared for control of fire and smoke dampers by means of the FPC.

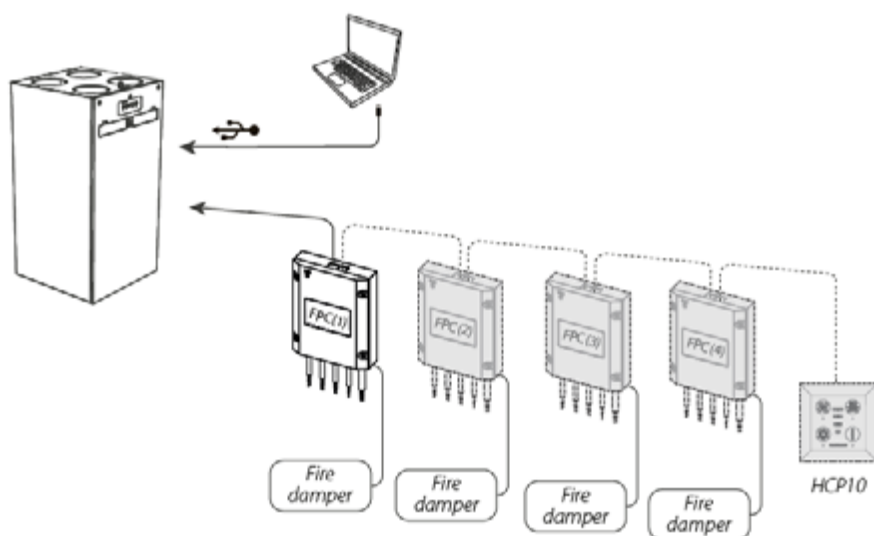

Fire Protection Controller set-up



Dimensions

# FIRE PROTECTION CONTROLLER (FPC)

The ventilation unit controls the FPC which in turn controls the fire and smoke dampers by means of the connected fire thermostats and smoke sensors. When a fire is detected, the ventilation unit is shut down and the fire and smoke dampers are closed. That stops smoke from spreading to other apartments. The ventilation keeps running in apartments where there is no fire.

**Fire control features:**

Activation of the digital input, for instance if fire or smoke is detected

- The ventilation unit is shut down
- The fire and smoke damper is closed

Loss of power or stopped ventilation unit

- The fire and smoke damper is closed

Faulty components, wiring and bus communication

- The ventilation unit is shut down
- The fire and smoke damper is closed
- The ventilation unit displays an FPC error and logs it in the alarm log

Weekly or monthly self-test

- Shuts down the ventilation unit, closes the fire and smoke damper and tests the position feedback
- Opens the fire and smoke damper, tests the position feedback and powers up the ventilation unit
- If faults are registered, the fire damper is closed, the ventilation unit is shut down and the display will report an error which will be registered in the alarm log

Manual test activated using the PC Tool in connection with

- Annual testing of automatic control as well as fire and smoke dampers
- Testing before apartment occupancy

After faults, the ventilation units must be reset manually using the control panel. Automatic and manual tests are registered in the alarm log of the unit.

Power	Unit	Connection
<b>Damper motor supply</b>	24V/230V AC	Terminal 1&2 Wago cage clamp
<b>Position feedback</b> Digital input for dry contact use SPDT connections for open/close feedback	12V/12mA	Terminal S1-S6 Wago cage clamp
Thermostat/smoke detector For dry contact use	12V/12mA	Terminal 10-11 Wago cage clamp
RS 485 communication ModBus RTU protocol	12V/A-B	RJ11 696C
Power consumption		Max 100mA