

NÁSTREŠNÉ VENTILÁTORY TORRETTE TR E-V

S VERTIKÁLNYM VÝFUKOM

www.vortice.sk

- Odsávacie ventilátory vhodné pre montáž na strechy obytných, komerčných a priemyselných budov.
- 20 modelov s vertikálnym výfukom a výkonom až 18000m³/h.
- Ventilátory s asynchrónnym indukčným motorom, s triedou ochrany IP55 a guľôčkovými ložiskami.
- Kryt ventilátora vyrobený z ocele s epoxidovým povrchovým náterom pre zabezpečenie odolnosti voči korózii a predĺženie životnosti.
- Aerodynamicky tvarovaný nasávací otvor z ocelového plechu s polyestrovou povrchovou úpravou.
- Obežné koleso z pozinkovanej ocele so samočistiteľnými, dozadu zahnutými lopatkami, chránené ochrannou mriežkou z nehrdzavejúcej ocele.
- Zariadenie je určené pre odsávanie čistého vzduchu - bez prachu, mastných častíc, sadzí, chemických a korozívnych čínidiel alebo výbušných či horľavých zmesí a ďalších znečistení vznikajúcich z výrobného procesu (napr. piliny...).
- Bezpečnostné lanko pre ukotvenie ventilátora k montážnemu základu.
- Závesné oká pre jednoduchú manipuláciu pri zdvíhaní a transporte.
- Zariadenie musí byť uzemnené.



Príklady montáže

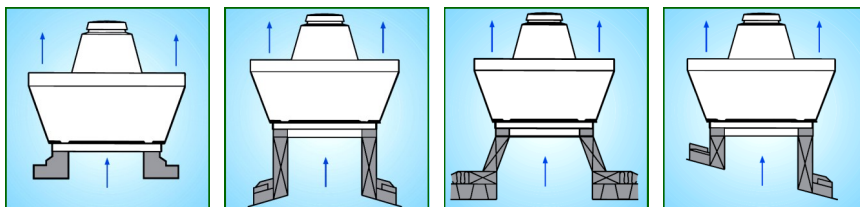

Jednoduchá a ľahká montáž na akýkoľvek typ strechy.

Technické parametre

	Kód	El. napájanie V~50 Hz	El. príkon [kW]	Prúd [A]	Póly	[Ot/min]	Vzduchový výkon		Výtlak [Pa]	Akustický tlak Lp (3m) [dB(A)]	Hmotnosť [kg]	Krytie IP	Max. teplota [°C]
							[m ³ /h]	[l/s]					
TRM 10 E-V 4P	15180	230	0,1	0,5	4	1400	1100	306	216	56	23	55	90
TRM 15 E-V 4P	15182	230	0,15	0,7	4	1400	1400	389	255	58,5	24	55	80
TRM 20 E-V 4P	15197	230	0,28	1,3	4	1415	2600	722	353	62	43	55	85
TRM 30 E-V 4P	15198	230	0,4	1,8	4	1425	3300	917	432	67	45	55	70
TRM 50 E-V 4P	15199	230	0,8	3,7	4	1480	4800	1333	540	72,5	51	55	80
TRM 70 E-V 4P	15188	230	1,0	4,35	4	1415	6400	1778	662	77	105	55	90
TRT 10 E-V 4P	15181	400	0,1	0,3	4	1400	1100	306	216	56	23	55	90
TRT 15 E-V 4P	15183	400	0,15	0,3	4	1400	1400	389	255	58,5	24	55	90
TRT 20 E-V 4P	15184	400	0,3	0,6	4	1400	2700	750	343	62	43	55	90
TRT 30 E-V 4P	15185	400	0,4	0,75	4	1400	3200	889	451	67	45	55	90
TRT 50 E-V 4P	15186	400	0,8	1,45	4	1400	4900	1361	598	72,5	51	55	90
TRT 70 E-V 4P	15187	400	0,95	1,85	4	1440	6400	1778	677	77	103	55	90
TRT 70 E-V 6P	15189	400	0,6	1,3	6	950	7000	1944	373	74	106	55	90
TRT 100 E-V 4P	15190	400	1,9	3,25	4	1420	10000	2778	829	84	107	55	70
TRT 100 E-V 6P	15191	400	1,1	2,3	6	950	10800	3000	471	77	161	55	85
TRT 100 E-V 8P	15192	400	0,93	2,1	8	715	11000	3056	334	71	171	55	80
TRT 150 E-V 6P	15193	400	1,93	3,45	6	930	15000	4167	598	80	172	55	80
TRT 150 E-V 8P	15194	400	1,6	3,1	8	715	15000	4167	441	74	176	55	75
TRT 180 E-V 6P	15195	400	3,1	5,95	6	970	16000	4444	775	83	174	55	80
TRT 210 E-V 6P	15196	400	3,4	6,4	6	980	18000	5000	775	84	176	55	70

Rozměry (mm)

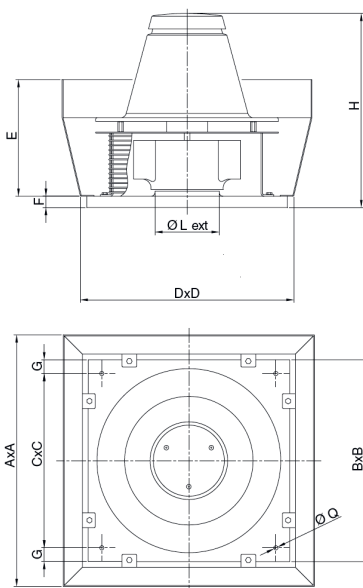

	kód	A	B	C	D	E	F	G	H	$\varnothing L$	$\varnothing Q$
TRM 10 E-V 4P	15180	652	410	357	440	328	38	26,5	502	170	11
TRM 15 E-V 4P	15182	652	410	357	440	328	38	26,5	502	182	11
TRM 20 E-V 4P	15197	907	550	500	580	432	38	25	586	219	11
TRM 30 E-V 4P	15198	907	550	500	580	432	38	25	604	244	11
TRM 50 E-V 4P	15199	907	550	500	580	432	38	25	631	278	11
TRM 70 E-V 4P	15188	1144	830	750	860	491	38	40	723	328	12
TRT 10 E-V 4P	15181	652	410	357	440	328	38	26,5	502	170	11
TRT 15 E-V 4P	15183	652	410	357	440	328	38	26,5	502	182	11
TRT 20 E-V 4P	15184	907	550	500	580	432	38	25	586	219	11
TRT 30 E-V 4P	15185	907	550	500	580	432	38	25	604	244	11
TRT 50 E-V 4P	15186	907	550	500	580	432	38	25	631	278	11
TRT 70 E-V 4P	15187	1144	830	750	860	491	38	40	723	328	12
TRT 70 E-V 6P	15189	1144	830	750	860	491	38	40	723	365	12
TRT 100 E-V 4P	15190	1144	830	750	860	491	38	40	723	365	12
TRT 100 E-V 6P	15191	1462	980	900	1010	595	38	40	903	415	12
TRT 100 E-V 8P	15192	1462	980	900	1010	595	38	40	903	415	12
TRT 150 E-V 6P	15193	1462	980	900	1010	595	38	40	903	415	12
TRT 150 E-V 8P	15194	1462	980	900	1010	595	38	40	903	415	12
TRT 180 E-V 6P	15195	1462	980	900	1010	595	38	40	903	415	12
TRT 210 E-V 6P	15196	1462	980	900	1010	595	38	40	903	415	12

Tlakovo - výkonové křivky

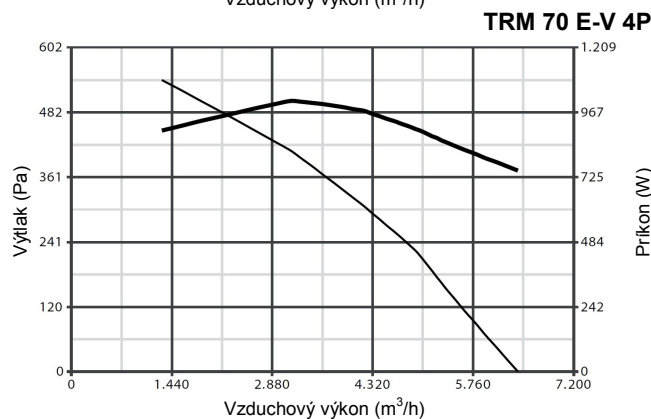
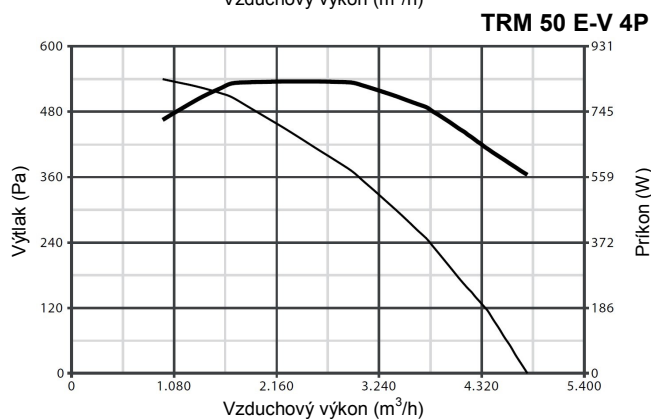
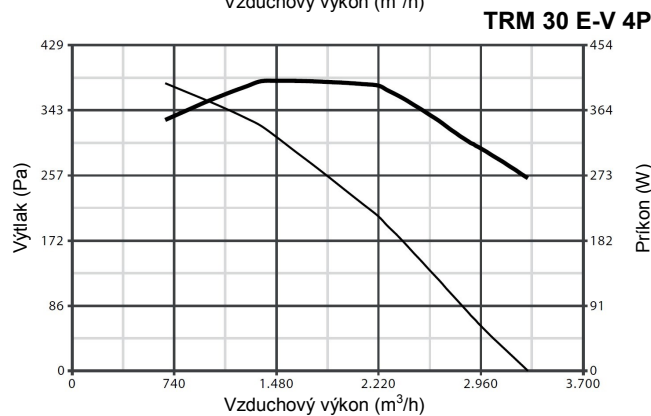
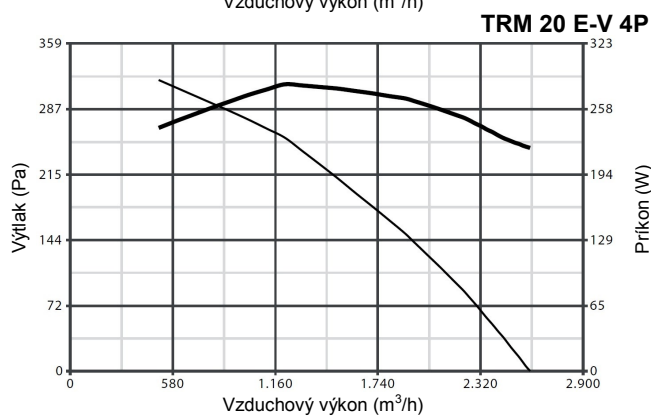
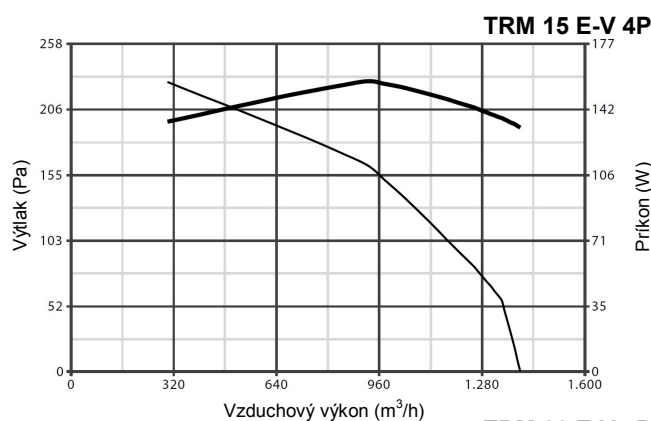
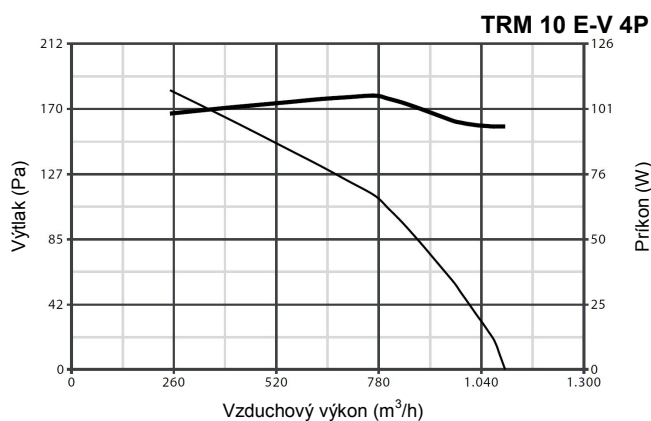

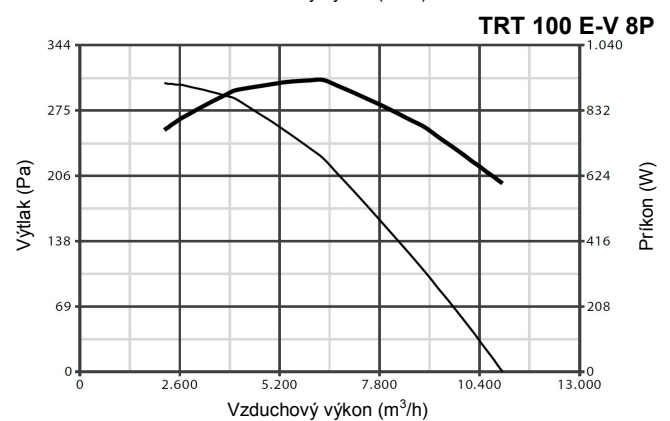
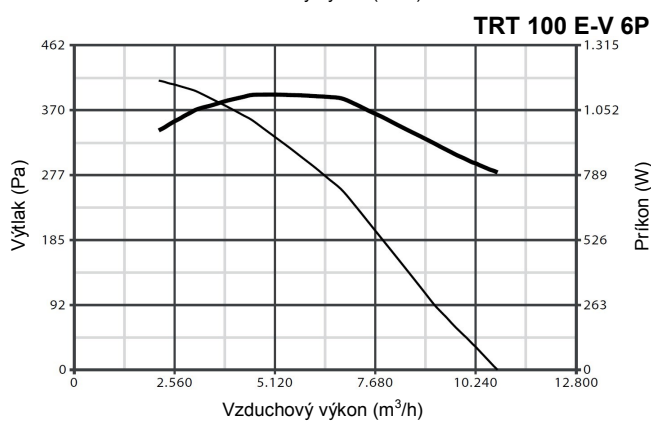
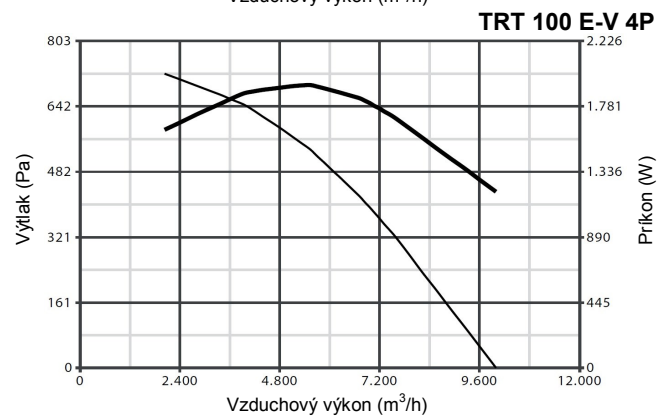
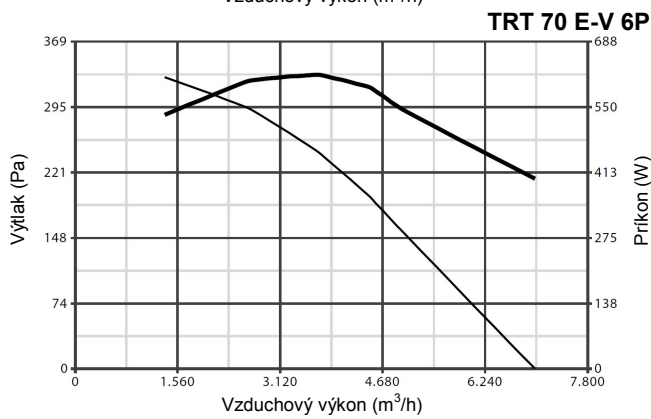
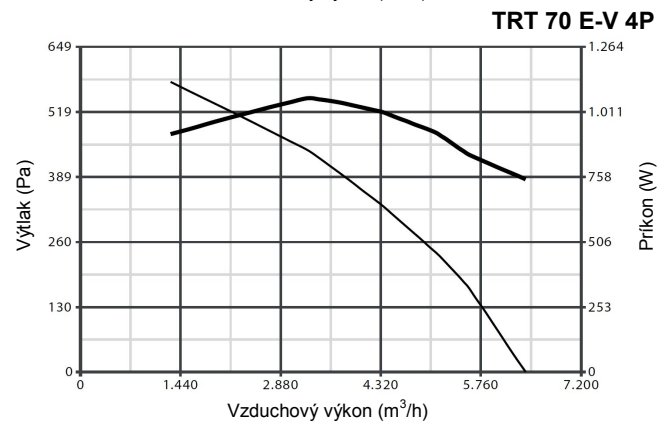
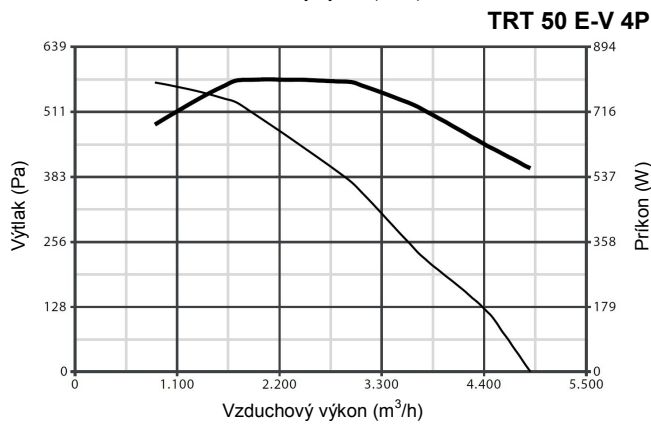
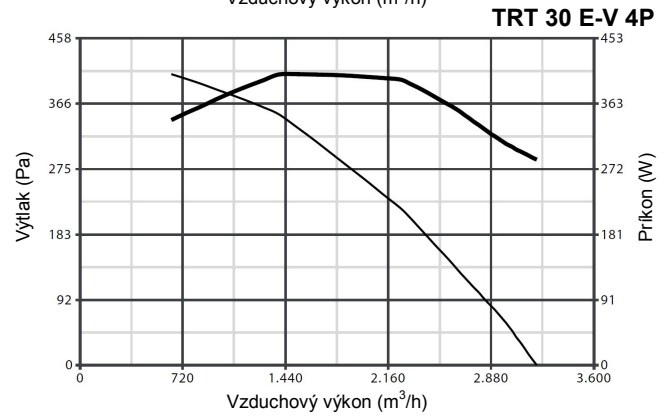
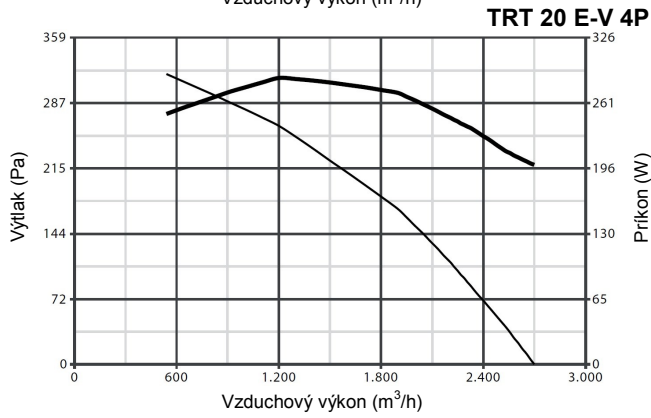
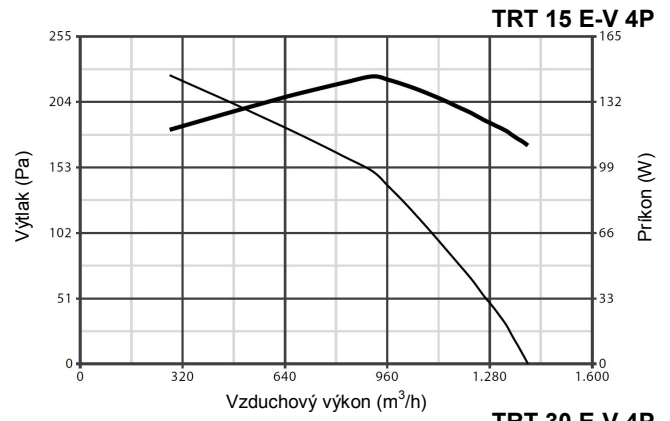
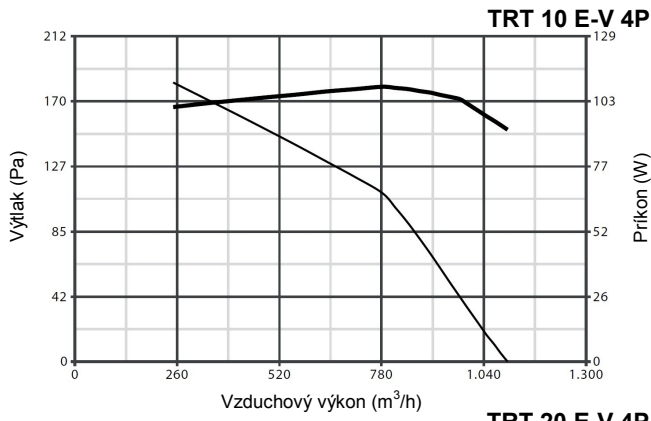

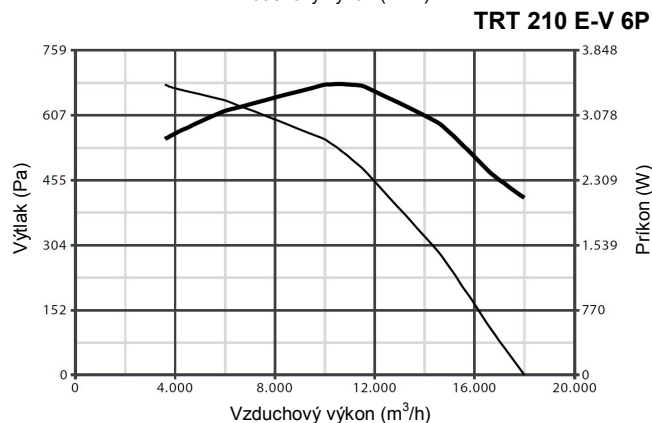
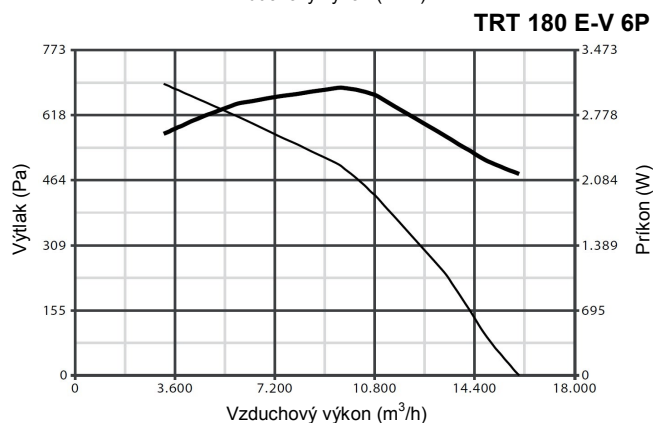
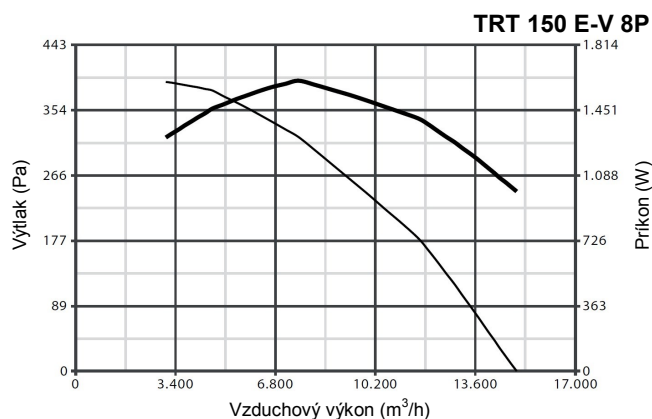
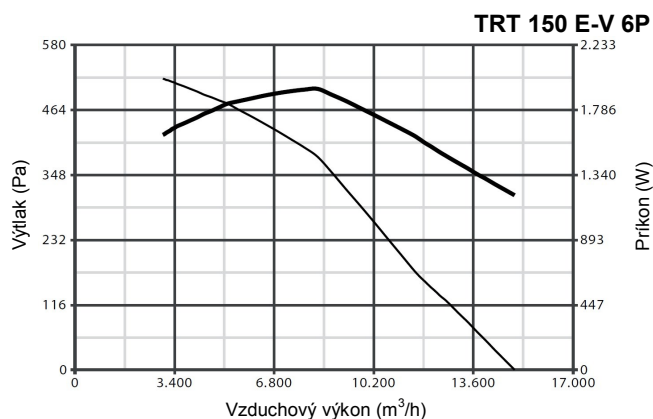

— Tlakovo - výkonová krivka
 — Krivka príkonu zariadenia

Kompatibilita ventilátorov a regulátorov otáčok

	Kód	C1.5	IRM 30	IRM 40	IRM 50	IRT 15	IRT 35	IRT 40	IREM 3	IREM 5	IREM 9	IRET 6	IREM INVERTER 1.4	IREM INVERTER 4.2	IREM INVERTER 7	IRET INVERTER 1.2	IRET INVERTER 2.2	IRET INVERTER 5	IRET INVERTER 8
TRM 10 E-V 4P	15180	X	X						X	X	X								
TRM 15 E-V 4P	15182	X	X						X	X	X								
TRM 20 E-V 4P	15197			X					X										
TRM 30 E-V 4P	15198			X					X										
TRM 50 E-V 4P	15199				X					X									
TRM 70 E-V 4P	15188									X	X								
TRT 10 E-V 4P	15181					X							X			X			
TRT 15 E-V 4P	15183					X							X			X			
TRT 20 E-V 4P	15184					X							X			X			
TRT 30 E-V 4P	15185						X						X			X			
TRT 50 E-V 4P	15186						X							X			X		
TRT 70 E-V 4P	15187							X				X					X		
TRT 70 E-V 6P	15189						X					X		X			X		
TRT 100 E-V 4P	15190							X				X			X			X	
TRT 100 E-V 6P	15191							X				X		X			X		
TRT 100 E-V 8P	15192						X					X		X			X		
TRT 150 E-V 6P	15193							X				X			X			X	
TRT 150 E-V 8P	15194							X				X			X			X	
TRT 180 E-V 6P	15195																		X
TRT 210 E-V 6P	15196																		X

Voliteľné príslušenstvo

- C1.5 jednofázový regulátor otáčok
- IRM (30, 40, 50) jednofázový regulátor otáčok
- IRT (15, 35, 40) trojfázový regulátor otáčok
- IREM (3, 5, 9) jednofázový regulátor otáčok
- IRET 9 trojfázový regulátor otáčok
- IREM INVERTER (1.4, 4.2, 7) - frekvenčný menič pre trojfázové modely
- IRET INVERTER (1.2, 2.2, 5, 8) - frekvenčný menič pre trojfázové modely
- TR-CU - základový rám
- TR-G - ochranná mriežka
- TR-S - spätná klapka
- TR-B - sací nástavec



Všetky výkonové údaje sú overené nezávislou skúšobňou, čo potvrdzuje štítok kvality a osvedčenie IMQ. Podlieha norme 2012/19/EU-WEEE.