

*Vortice main company's philosophy is the concept that "air is our life". Our mission is always to provide effective solutions for improved air quality using the latest technology to develop and manufacture effective products worldwide.*

Our current Vortice Headquarters have been located in Tribiano (Milan) since 1972.

Vortice has achieved European market leadership by dedicating their efforts to the production of products for ventilation, climate control, heating, extraction, purification and the treatment of air, for domestic, commercial and industrial applications. Since 1954 Vortice has been synonymous with quality and excellence and continues to make significant improvements by investing in continuous research to improve the efficiency and quality of its products.

## VORTICE IN THE WORLD

FRANCE



Founded in 1974, Vortice France is located at Créteil about 10 Km from Paris.

ENGLAND



Founded in 1977, Vortice Limited is located at Burton on Trent in the East Midlands.

CHINA



Founded in 2012, Vortice Ventilation System is located about 200 Km from Shanghai.

SOUTH AMERICA



Founded in 2012, Vortice Latam is located in San José, Costa Rica.





# INDEX

05	<b>LEGEND</b>	54	<b>VORTEX® RANGE</b> Cooker hoods
06	<b>PUNTO RANGE</b> Wall/window axial fans	58	<b>ARIETT RANGE</b> Centrifugal duct fans
12	<b>PUNTO FILO RANGE</b> Wall axial fans	62	<b>ARIETT HABITAT RANGE</b> Centrifugal duct fans
16	<b>PUNTO FOUR RANGE</b> Wall axial fans	64	<b>ARIETT I RANGE</b> Centrifugal duct fans for flush mounting
20	<b>PUNTO GHOST RANGE</b> In-line axial fans	70	<b>VORT PRESS RANGE</b> Centrifugal duct fans
24	<b>PUNTO EVO FLEXO RANGE</b> Wall axial fans	74	<b>VORT PRESS HABITAT RANGE</b> Centrifugal duct fans
28	<b>PUNTO EVO RANGE</b> Wall axial fans	78	<b>VORT PRESS I RANGE</b> Centrifugal duct fans for flush mounting
34	<b>PUNTO EVO ES RANGE</b> Wall axial fans energy savings	82	<b>VORT QUADRO RANGE</b> Centrifugal duct fans
38	<b>PUNTO EVO GOLD RANGE</b> Wall axial fans	88	<b>VORT QUADRO I RANGE</b> Centrifugal duct fans for flush mounting
42	<b>VORTICE VARIO RANGE</b> Wall/window axial fans	94	<b>VORT QUADRO EVO RANGE</b> Residential centrifugal extractor fans
46	<b>VORTICE VARIO I RANGE</b> Flush mounted axial fans	102	<b>VORT NOTUS RANGE</b> De-centralised continuous axial fans
50	<b>K RANGE</b> In-line centrifugal fans for kitchen cabinet	106	<b>RESIDENTIAL VENTILATION ACCESSORIES</b>

## CE MARKING

Residential Ventilation products comply with the following European Directives:

2006/95/EC Low Voltage Directive (LVD)  
2004/108/EC Electromagnetic Compatibility Directive (EMC)

According to the following state-of-the-art Standards:

### Safety

EN 60335-1, EN 60335-2-80, EN 60335-2-40, EN 622233

### Electromagnetic Compatibility

EN 55014-1; EN 55014-2; EN 61000-3-2; EN 61000-3-3



We work to promote life quality  
and to contribute to the social evolution  
through eco-friendly products  
that move air **safely and efficiency.**



[vortice.com](http://vortice.com)





# LEGEND



## SILENT RUNNING AND CERTIFIED, GUARANTEED PERFORMANCE

IMQ PERFORMANCE is an independent quality mark which certifies, according to international standards, performances (air flow and pressure) and noise levels of the product.



## SAFE

Safety, power rating, enclosure protection rating (IP44 to EN 60529) and electrical insulation are certified by IMQ (Quality Mark Institute), the Italian national certifying agency. The IMQ mark certifies that the product is manufactured in compliance with the provisions of relevant established safety standards and directives: (EN 60335-1, EN 60335-2-80 and EN 62333) Low Voltage Directive (LVD) and Electromagnetic Compatibility Directive (EMC). IMQ also guarantees regular, constant monitoring of production quality.



## ENERGY SAVING

ES label means that the appliance is fitted with EC Brushless motor and provides high energy savings, thanks to a wide range of speed regulation options and very low consumption levels.



## ERP COMPLIANT

The ErP compliant logo indicates that the appliance is ecocompatible and adheres to the ErP directive 2009/125/CE.

**LONG LIFE 30.000 h**

## LONG LIFE 30.000 H

The Long Life 30,000 h label certifies that the appliance is guaranteed to continuously run at max operating temperature for 30,000 hours without mechanical failure thanks to its motor, equipped with ball bearings.

**STANDARD**

## STANDARD

All models are manufactured with shielded poles and have bronze bearings for a long life

**AUTOMATIC**

## AUTOMATIC

The integral shutters positioned behind the front grille automatically open and close slowly when the unit is operated. The shutters are made from shockproof, anti-UV-treated, plastic.

**TIMER**

## TIMER

The timer comes on when the light is switched on. When the light is turned off, the unit continues to operate for 3 to 20 minutes, depending on the timer setting.

**PIR** Passive Infrared

## PIR

The unit turns on a few seconds after the person has entered the room (sensor is located in an inclined position to increase sensitivity), and continues to operate during the person's presence. When the person leaves the room, the unit will continue to run from between 3 to 20 minutes depending on the timer setting.

**T-HCS** Humidity Control System - Timer

## T-HCS

The appliance features a relative humidity sensor that is factory set at 60%. When relative humidity exceeds that level, the appliance automatically starts up. This threshold setting can however be modified by the installer to 4 levels: 60%, 70%, 80%, and 90%. The unit turns off when the RH drops back to 60% and when the light is switched off, the unit continues to run between 3 to 20 minutes depending on the timer setting.

**12 V** Power Supply Unit

## 12 V

A power supply unit is needed wherever the use of low-voltage equipment is required. The two available low-voltage fans - one with and one without automatic shutter - can be used in combination with any of the power supply units.

**PULLCORD**

## PULLCORD

The unit is switched on by pulling the insulated pull cord.



Design: F. Trabucco & Associates



## PUNTO RANGE

Wall/window axial fans **LONG LIFE 30.000 h**

For intermittent or continuous ventilation of bathrooms, toilets, kitchens or utility rooms in domestic or commercial properties.

- **53 models:** from Ø 100 to 150 available with or without the option of automatic shutters, timer, pull cord, humidistat, electronic microprocessor and Passive infrared.
- Motor with shielded poles, either with bronze or ball bearings, and with thermal cut-out.
- Motor support and grille made of anti-UV ABS.
- High airflow rate, low operating noise level and low power consumption due to the wing profile blades and motor support.
- The standard models can be speed regulated.
- Protection rating: IPX4.
- Insulation class: II .

### Punto 12V.

- **8 models:** available with or without automatic shutters; In the automatic version the shutters positioned behind the front grille automatically open and close slowly when the unit is operated.
- The shutters are made from shockproof, anti-UV-treated plastic.
- 12V motor with shielded poles, bronze bearings and thermal cut-out.
- Insulation: Selv CI.III.

### Punto PIR

- **12 models:** The unit turns on a few seconds after the person has entered the room (sensor is located in an inclined position to increase sensitivity), and continues to operate during the person's presence. When the person leaves the room, the unit will continue to run from between 3 to 20 minutes depending on the timer setting.

### Punto T-HCS.

- **3 models:** adjustable RH threshold at 60%, 70%, 80%, 90% by mean of a slide switch during installation.
- Smart working mode: the product automatically switches on when the indoor relative humidity level exceeds the pre-set value. A timer automatically switches off the product when the relative humidity decreases under the pre-set limit.





## RANGE

Diam.	BASIC	TIMER	PIR	BASE AUTOMATIC	TIMER AUTOMATIC	PIR AUTOMATIC
Ø100	<b>11201</b> M 100/4" <b>11641</b> M 100/4" P	<b>11211</b> M 100/4" T	<b>11681</b> M 100/4" PIR	<b>11221</b> M 100/4" A <b>11646</b> M 100/4" AP	<b>11231</b> M 100/4" AT	<b>11683</b> M 100/4" A PIR
Ø120	<b>11301</b> M 120/5" <b>11741</b> M 120/5" P	<b>11311</b> M 120/5" T	<b>11781</b> M 120/5" PIR	<b>11321</b> M 120/5" A <b>11746</b> M 120/5" AP	<b>11331</b> M 120/5" AT	<b>11783</b> M 120/5" A PIR
Ø150	<b>11401</b> M 150/6" <b>11851</b> M 150/6" P	<b>11411</b> M 150/6" T	<b>11881</b> M 150/6" PIR	<b>11421</b> M 150/6" A <b>11856</b> M 150/6" AP	<b>11431</b> M 150/6" AT	<b>11883</b> M 150/6" A PIR

Diam.	BASIC LONG LIFE	TIMER LONG LIFE	PIR LONG LIFE	LONG LIFE AUTOMATIC	TIMER AUTOMATIC LONG LIFE	PIR AUTOMATIC LONG LIFE	TIMER AUTOMATIC HCS LONG LIFE
Ø100	<b>11202</b> M 100/4" LL	<b>11212</b> M 100/4" T LL	<b>11682</b> M 100/4" PIR LL	<b>11222</b> M 100/4" A LL	<b>11232</b> M 100/4" AT LL	<b>11684</b> M 100/4" A PIR LL	<b>11616</b> M 100/4" AT HCS LL
Ø120	<b>11302</b> M 120/5" LL	<b>11312</b> M 120/5" T LL	<b>11782</b> M 120/5" PIR LL	<b>11322</b> M 120/5" A LL	<b>11332</b> M 120/5" AT LL	<b>11784</b> M 120/5" A PIR LL	<b>11692</b> M 120/5" AT HCS LL
Ø150	<b>11402</b> M 150/6" LL	<b>11412</b> M 150/6" T LL	<b>11882</b> M 150/6" PIR LL	<b>11422</b> M 150/6" A LL	<b>11432</b> M 150/6" AT LL	<b>11884</b> M 150/6" A PIR LL	<b>11698</b> M 150/6" AT HCS LL

Diam.	BASIC 12 V	TIMER 12V	BASE AUTOMATIC 12 V	TIMER AUTOMATIC 12V
Ø100	<b>11203</b> M 100/4" 12V <b>22150</b> GA 12V	<b>11203</b> M 100/4" 12V <b>22150</b> GA 12V T	<b>11223</b> M 100/4" A 12V <b>22150</b> GA 12V	<b>11223</b> M 100/4" A 12V <b>22151</b> GA 12V T

## TECHNICAL DATA

MODELS	V~50HZ	W max	A max	RPM max	MAX AIRFLOW		MAX PRESSURE		Lp dB(A) 3m max	MAX °C	KG
					m³/h	l/s	mmH <sub>2</sub> O	Pa			
M 100/4"	220-240	18	0.10	2300	90	25	3	29	37.5	50	0.60
M 120/5"	220-240	20	0.12	2100	175	48.6	4.5	44	39.5	50	0.80
M 150/6"	220-240	30	0.15	2100	335	93.1	6	59	46.0	50	1.10



## RESIDENTIAL VENTILATION

### PUNTO RANGE

#### PUNTO RANGE | TECHNICAL DATA FOR REGULATION N° 1254/2014/UE

	UNIT OF MEASURE	M 90/3.5"	M 100/4"	M 120/5"	M 150/6"
Supplier's name or trade mark	-	Vortice	Vortice	Vortice	Vortice
Specific Energy Consumption class SEC in average climate zone	-	NA*	NA*	NA*	NA*
Specific Energy Consumption class SEC average		-4.1	-6.6	-8.0	-9.7
Specific Energy Consumption class SEC cold	kWh/m <sup>2</sup> year	-17.5	-20.0	-21.3	-23.0
Specific Energy Consumption class SEC warm		3.5	1.0	-0.3	-20
Declared typology	-	RVU-U*	RVU-U*	RVU-U*	RVU-U*
Type of drive	-	NA	NA	NA	NA
Type of heat recovery system HRS	-	none	none	none	none
Thermal efficiency of heat recovery at reference air flow	%	NA*	NA*	NA*	NA*
Maximum flow rate	m <sup>3</sup> /h	67	89	164	324
Electric power input of the fan drive, including any motor control equipment, at maximum flow rate	W	13.3	13.7	20.6	27.8
Sound power level LWA	LWA [DB(A)]	60	58	60	67
Reference flow rate	m <sup>3</sup> /s	0.0129	0.173	0.0319	0.630
Reference pressure difference	Pa	20	15	20	28
SPI	W/(m <sup>3</sup> /h)	0.28571	0.21348	0.17422	0.12434
Control factor CTRL	-	1	1	1	1
Control typology	-	manual	manual	manual	manual
Maximum internal leakage rates	%	NA	NA	NA	NA
Maximum external leakage rates	%	NA	NA	NA	NA
Mixing rate	-	NA	NA	NA	NA
Position and description of visual filter warning	-	NA	NA	NA	NA
Airflow sensitivity to pressure variations at + 20 Pa and - 20 Pa	-	NA	NA	NA	NA
Indoor/outdoor air tightness	m <sup>3</sup> /h	NA	NA	NA	NA
Annual electricity consumption (AEC)	kWh electricity/year	394	294	240	171
AHS average Annual heating saved		1397	1397	1397	1397
AHS cold Annual heating saved	kWh primary energy/year	2732	2732	2732	2732
AHS warm Annual heating saved		632	632	632	632

\* RVU-U: Unit Ventilation Residential - Unidirectional

\*\* NRVU-U: Unit Ventilation Non Residential - Unidirectional

\*\*\* MSD: Multi-Speed Drive

NA: Not applicable





DIMENSIONS

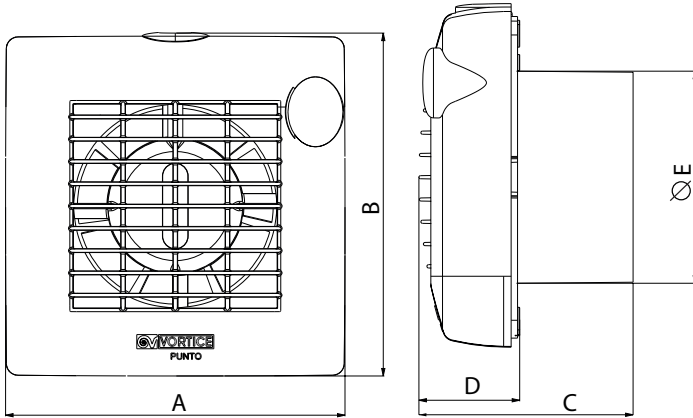

MODELS	A	B	C	D	∅E
M 100/4"	159	160	100	47	99
M 120/5"	179	181	110	47	119
M 150/6"	214	215	117	47	156

Dimensions (mm)

PERFORMANCE CURVES

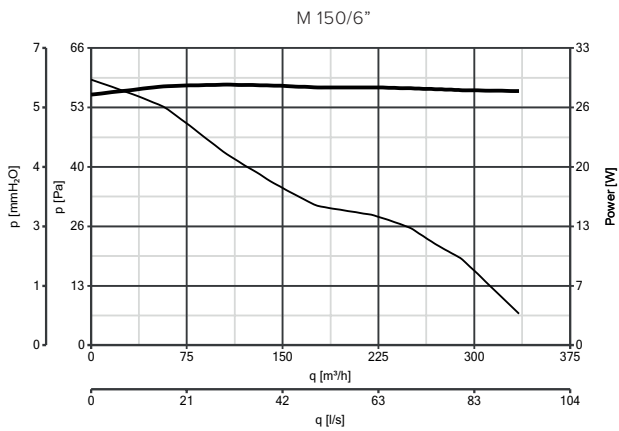
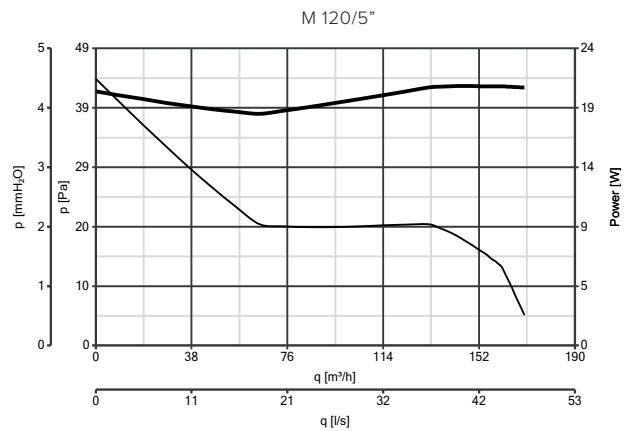
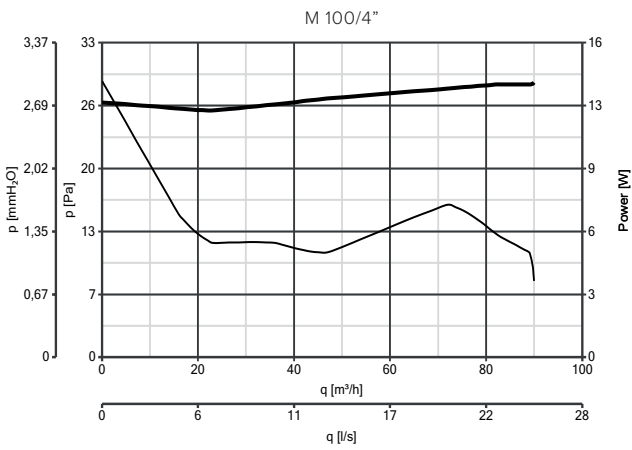



— Power consumption  
— Delivery





## RESIDENTIAL VENTILATION

PUNTO RANGE

### CONTROLLER

MODELS	DESCRIPTION	CODE	PRODUCT
	<b>IREM 30</b> - Single phase speed controller	12912	All products
	<b>C 1.5</b> - Electronic speed controller 1.5 A	12966	11201- 11202 - 11222 - 11301 - 11302 11321 - 11322 - 11401 - 11402 - 11421 - 11422
	<b>SCNRB</b> - Electronic speed controller built-in	12971	11201- 11202 - 11221 - 11222 - 11301 11302 - 11321 - 11322 - 11401 - 11402 - 11421 11422
	<b>SCB KIT</b> - Built-in controller adaptor for C 1.5	22481	12966

### ACCESSORIES ON REQUEST

MODELS	DESCRIPTION	CODE	PRODUCT
		100/4"	11201 - 11202 - 11203 - 11211 - 11212 - 11681 - 11682 - 11221 - 11222 - 11223 - 11231 - 11232 - 11683 - 11684 - 11616
	<b>F KIT</b> - Kit to window-mount	120/5"	11783 - 11321 - 11322 - 11331 - 11332 - 11781 - 11782 - 11784 - 11692
		150/6"	11401 - 11402 - 11411 - 11412 - 11881 - 11882 - 11421 - 11422 - 11431 - 11432 - 11883 - 11884 - 11698
		100/4"	11201 - 11202 - 11203 - 11211 11212 - 11681 - 11682 - 11221 - 11222 - 11223 11231 - 11232 - 11683 - 11684 - 11616
	<b>S KIT</b> - Ceiling kit	120/5"	11301 - 11302 - 11311 - 11312 - 11781 - 11782 - 11783 - 11321 - 11322 - 11331 - 11332 - 11784 - 11692
		150/6"	11401 - 11402 - 11411 - 11412 - 11881 - 11882 - 11421 - 11422 - 11431 - 11432 - 11883 - 11884 - 11698
	<b>GA</b>	12V	11203 - 11223
		12V T	11203 - 11223

### F KIT - KIT TO WINDOW-MOUNT TECHNICAL DATA AND DIMENSIONS OF THE "PRODUCT+KIT".

MODELS	KIT	CODE	W	A	RPM	MAX AIRFLOW		LP DB(A) 3m	MAX °C	KG
						m³/h	l/s			
M 100/4"	F 100/4"	22131	18	0.10	2300	85	23.6	38	50	0.85
M 120/5"	F 120/5"	22132	20	0.12	2000	140	38.9	40.5	50	1.15
M 150/6"	F 150/6"	22133	30	0.15	1950	280	77.8	44.5	50	1.56

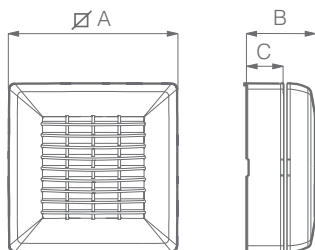

MODELS	Ø A	B	C	Ø GLASS HOLE	THICKNESS
M 100/4"	158	69	22	123 ÷ 128	20
M 120/5"	179	80	33	143 ÷ 148	20
M 150/6"	213	87	40	178 ÷ 183	20

Dimensions (mm)





APPLICATIONS





Design: F. Trabucco &amp; Associates



## PUNTO FILO RANGE

 Wall axial fans **LONG LIFE 30.000h**

For intermittent or continuous ventilation of bathrooms, toilets, kitchens or utility rooms in domestic or commercial properties.

- **21 models:** from 90 to 150 diameters, standard, timer, long life versions.
- Integral backdraught shutter: already installed on the appliance, it prevents unwanted air from getting back in when the appliance is switched off.
- Very silent.
- Quick and easy installation.
- Eco-Friendly: it guarantees a low environmental impact.
- Only 17 mm thickness.
- **Punto Filo T-HCS:** 3 models.  
Adjustable Relative Humidity threshold at 60%, 70%, 80%, 90% by mean of a slide switch during installation.
- Protection rating: IPX4.
- Insulation class: II

### RANGE

Diam.	BASIC	TIMER	LONG LIFE	TIMER LONG LIFE	TIMER HCS LONG LIFE	PIR LONG LIFE
Ø90	<b>11122</b> MF 90/3.5"	<b>11126</b> MF 90/3.5" T	-	-	<b>11138</b> MF 90/3.5" THCS LL	-
Ø100	<b>11123</b> MF 100/4"	<b>11127</b> MF 100/4" T	<b>11131</b> MF 100/4" LL	<b>11135</b> MF 100/4" T LL	<b>11139</b> MF 100/4" THCS LL	<b>11185</b> MF 100/4" PIR LL
Ø120	<b>11124</b> MF 120/5"	<b>11128</b> MF 120/5" T	<b>11132</b> MF 120/5" LL	<b>11136</b> MF 120/5" T LL	<b>11149</b> MF 120/5" THCS LL	<b>11186</b> MF 120/5" PIR LL
Ø150	<b>11125</b> MF 150/6"	<b>11129</b> MF 150/6" T	<b>11133</b> MF 150/6" LL	<b>11137</b> MF 150/6" T LL	<b>11176</b> MF 150/6" THCS LL	<b>11187</b> MF 150/6" PIR LL

### TECHNICAL DATA

MODELS	V~50HZ	W max	A max	RPM max	MAX AIRFLOW		MAX PRESSURE		Lp dB(A) 3m max	MAX °C	KG
					m³/h	l/s	mmH <sub>2</sub> O	Pa			
MF 90/3.5"	220-240	14	0.08	2500	65	18	2.5	25	28.8	50	0.50
MF 100/4"	220-240	15	0.09	2400	85	24	3	29	31.0	50	0.51
MF 120/5"	220-240	20	0.12	2150	175	49	5	49	34.4	50	0.61
MF 150/6"	220-240	28	0.15	2100	335	93	6	59	40.1	50	0.97



## PUNTO FILO RANGE | TECHNICAL DATA FOR REGULATION N° 1254/2014/UE

	UNIT OF MEASURE	MF 90/3.5"	MF 100/4"	MF 120/5"	MF 150/6"
Supplier's name or trade mark	-	Vortice	Vortice	Vortice	Vortice
Specific Energy Consumption class SEC in average climate zone	-	NA*	NA*	NA*	NA*
Specific Energy Consumption class SEC average		-2.5	-5.4	-8.8	-9.9
Specific Energy Consumption class SEC cold	kWh/m <sup>2</sup> year	-15.9	-18.7	-22.1	-23.2
Specific Energy Consumption class SEC warm		5.1	2.3	1.1	-2.2
Declared typology	-	RVU-U*	RVU-U*	RVU-U*	RVU-U*
Type of drive	-	NA	NA	NA	NA
Type of heat recovery system HRS	-	none	none	none	none
Thermal efficiency of heat recovery at reference air flow	%	NA	NA	NA	NA
Maximum flow rate	m <sup>3</sup> /h	55	78	173	332
Electric power input of the fan drive, including any motor control equipment, at maximum flow rate	W	12.9	14.1	21.4	26.7
Sound power level LWA	LWA [DB(A)]	49	52	60	61
Reference flow rate	m <sup>3</sup> /s	0.0107	0.0152	0.0336	0.0646
Reference pressure difference	Pa	19	17	24	32
SPI	W/(m <sup>3</sup> /h)	0.33247	0.24908	0.15111	0.11833
Control factor CTRL	-	1	1	1	1
Control typology	-	manual	manual	manual	manual
Maximum internal leakage rates	%	NA	NA	NA	NA
Maximum external leakage rates	%	NA	NA	NA	NA
Mixing rate	-	NA	NA	NA	NA
Position and description of visual filter warning	-	NA	NA	NA	NA
Airflow sensitivity to pressure variations at + 20 Pa and - 20 Pa	-	NA	NA	NA	NA
Indoor/outdoor air tightness	m <sup>3</sup> /h	NA	NA	NA	NA
Annual electricity consumption (AEC)	kWh electricity/year	458	343	208	163
AHS average Annual heating saved		1397	1397	1397	1397
AHS cold Annual heating saved	kWh primary energy/year	2732	2732	2732	2732
AHS warm Annual heating saved		632	632	632	632

\* RVU-U: Unit Ventilation Residential - Unidirectional

\*\* NRVU-U: Unit Ventilation Non Residential - Unidirectional

\*\*\* MSD: Multi-Speed Drive

NA: Not applicable



# RESIDENTIAL VENTILATION

PUNTO FILO RANGE

## DIMENSIONS

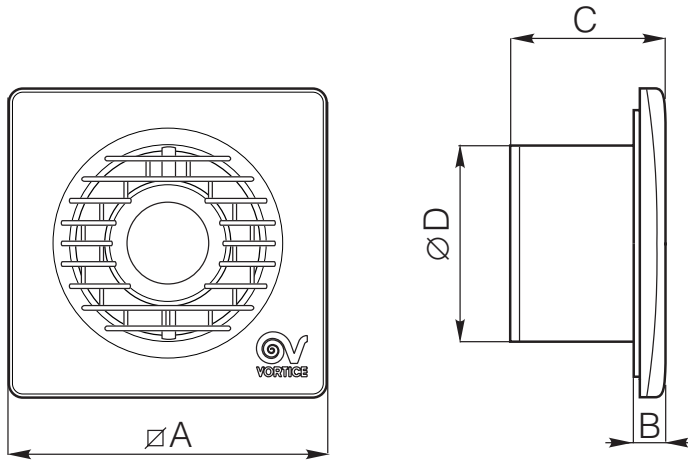

MODELS	Ø A	B	C	Ø D
MF 90/3.5"	159	17	77	92.5
MF 100/4"	159	17	77	98
MF 120/5"	179	17	89	119
MF 150/6"	214	17	96	156

Dimensions (mm)

## PERFORMANCE CURVES

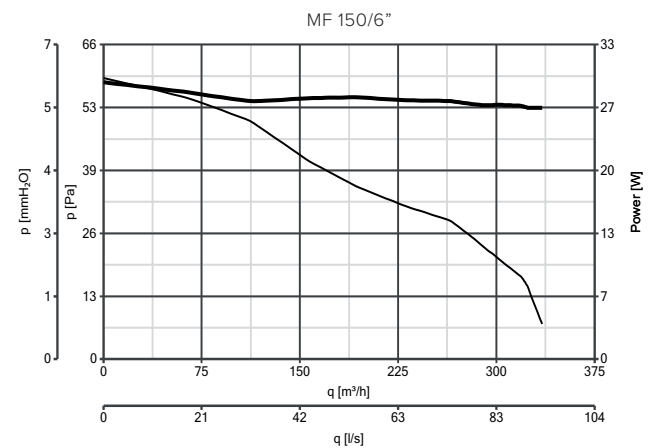
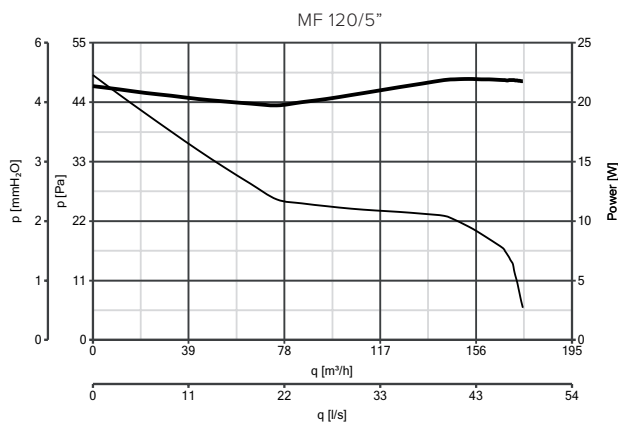
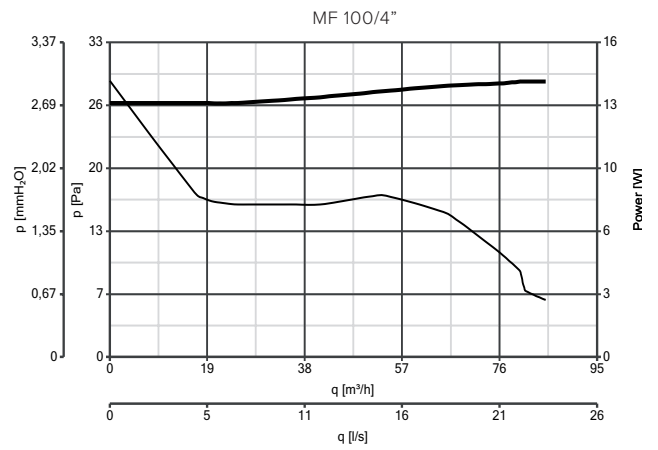
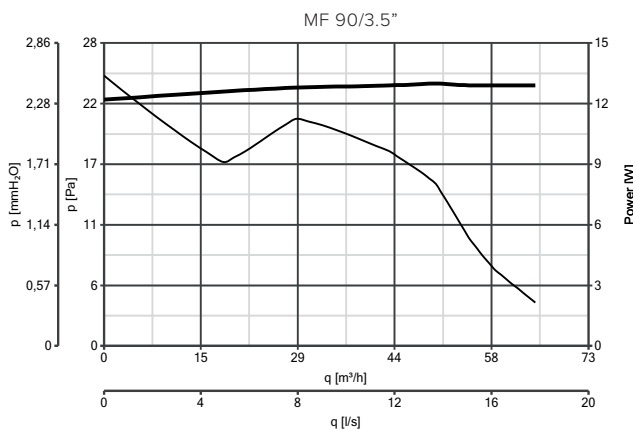



— Power consumption — Delivery





CONTROLLER

MODELS	DESCRIPTION	CODE	PRODUCT
	<b>C 1.5</b> - Electronic speed controller 1.5 A	12966	11122 - 11123 - 11131 - 11124 - 11132 11125 - 11133
	<b>SCB KIT</b> - Built-in controller adaptor for C 1.5	22481	12966

ACCESSORIES ON REQUEST

MODELS	DESCRIPTION	CODE	PRODUCT
	<b>SF KIT</b> - Ceiling kit	90 - 100	22162 11122 - 11126 - 11138 - 11123 - 11131 - 11127 - 11135 - 11185 - 11139
		120	22163 11124 - 11132 - 11128 - 11136 - 11186 - 11149
		150	22164 11125 - 11133 - 11129 - 11137 - 11187 - 11176

APPLICATIONS

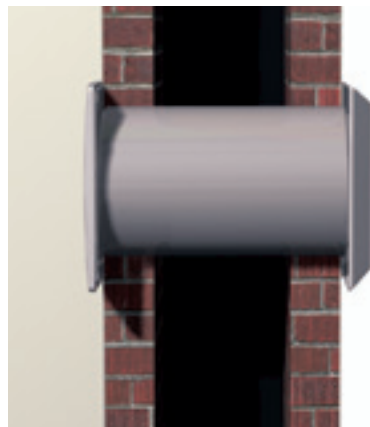



Design: F. Trabucco & Associates



## PUNTO FOUR RANGE

Wall axial fans

For intermittent or continuous ventilation of bathrooms, toilets, kitchens or utility rooms in domestic or commercial properties.

- **6 models:** from 90 to 120 diameters, with or without timer.
- Body made of ABS plastic anti-UV.
- Integral backdraught shutter.
- Timer models adjustable between 3 and 20 minutes.
- Standard models can be speed regulated.
- Easy to clean and to maintain.
- Ceiling installation and wall installation.
- Protection rating: IPX4.
- Insulation class: II

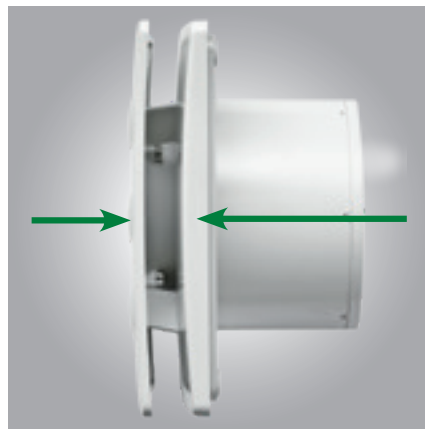

### TECHNICAL DATA

MODELS	CODE		V~50HZ	W max	A max	RPM max	MAX AIRFLOW		MAX PRESSURE		Lp dB(A) 3m max	MAX °C	KG
	BASIC	TIMER					m³/h	l/s	mmH₂O	Pa			
MFO 90/3.5"	11143	11144	220-240	14	0.08	2540	65	18	2.5	25	29.6	50	0.55
MFO 100/4"	11145	11146	220-240	15	0.09	2400	85	24	3.0	29	33.1	50	0.55
MFO 120/5"	11147	11148	220-240	20	0.12	2240	175	49	5.0	49	39.1	50	0.78



## PUNTO FOUR RANGE | TECHNICAL DATA FOR REGULATION N° 1254/2014/UE

	UNIT OF MEASURE	MFO 90/3.5"	MFO 100/4"	MFO 120/5"
Supplier's name or trade mark	-	Vortice	Vortice	Vortice
Specific Energy Consumption class SEC in average climate zone	-	NA*	NA*	NA*
Specific Energy Consumption class SEC average	-	-2.1	-4.1	-8.9
Specific Energy Consumption class SEC cold	kWh/m <sup>2</sup> year	-15.5	-17.5	-22.3
Specific Energy Consumption class SEC warm	-	5.6	3.5	1.3
Declared typology	-	RVU-U*	RVU-U*	RVU-U*
Type of drive	-	NA	NA	NA
Type of heat recovery system HRS	-	none	none	none
Thermal efficiency of heat recovery at reference air flow	%	NA	NA	NA
Maximum flow rate	m <sup>3</sup> /h	54	68	171
Electric power input of the fan drive, including any motor control equipment, at maximum flow rate	W	12.9	14.0	18.5
Sound power level LWA	LWA [DB(A)]	50	54	60
Reference flow rate	m <sup>3</sup> /s	0.0104	0.0132	0.0333
Reference pressure difference	Pa	19	14	19
SPI	W/(m <sup>3</sup> /h)	0.34446	0.28571	0.14620
Control factor CTRL	-	1	1	1
Control typology	-	manual	manual	manual
Maximum internal leakage rates	%	NA	NA	NA
Maximum external leakage rates	%	NA	NA	NA
Mixing rate	-	NA	NA	NA
Position and description of visual filter warning	-	NA	NA	NA
Airflow sensitivity to pressure variations at + 20 Pa and - 20 Pa	-	NA	NA	NA
Indoor/outdoor air tightness	m <sup>3</sup> /h	NA	NA	NA
Annual electricity consumption (AEC)	kWh electricity/year	475	394	201
AHS average Annual heating saved	-	1397	1397	1397
AHS cold Annual heating saved	kWh primary energy/year	2732	2732	2732
AHS warm Annual heating saved	-	632	632	632

\* RVU-U: Unit Ventilation Residential - Unidirectional

\*\* NRVU-U: Unit Ventilation Non Residential - Unidirectional

\*\*\* MSD: Multi-Speed Drive

NA: Not applicable



## RESIDENTIAL VENTILATION

### PUNTO FOUR RANGE

#### DIMENSIONS

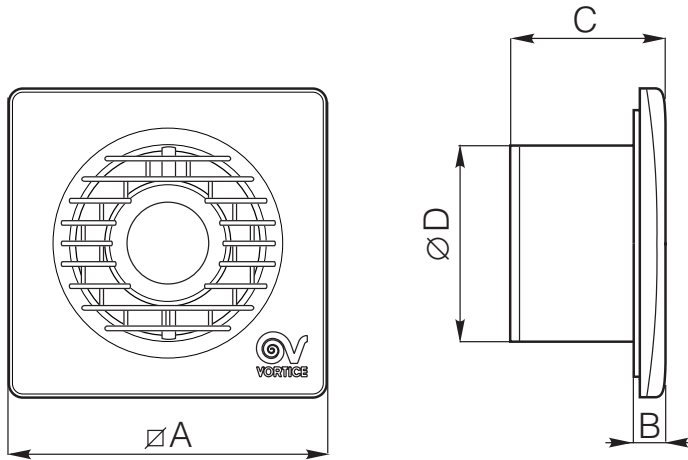

MODELS	Ø A	B	C	Ø D
MFO 90/3.5"	158	37	97	92.4
MFO 100/4"	158	37	97	98.4
MFO 120/5"	178	42.3	114	118.9

Dimensions (mm)

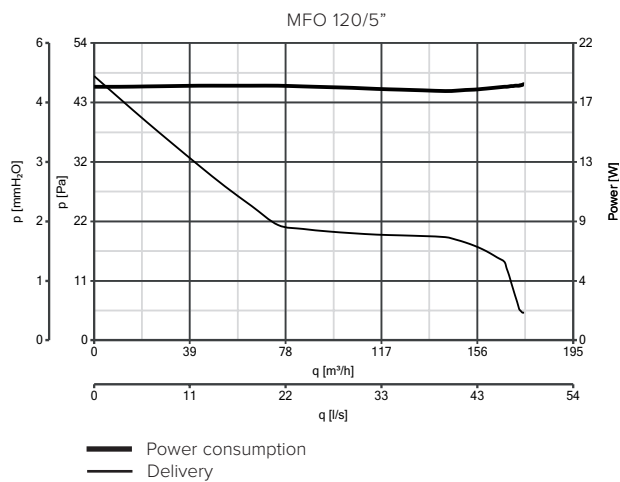
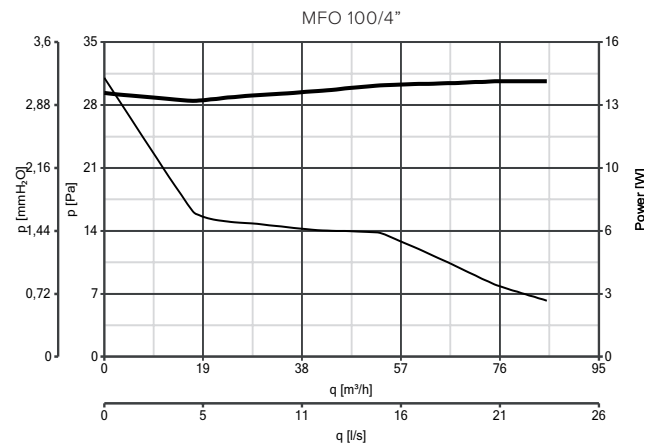
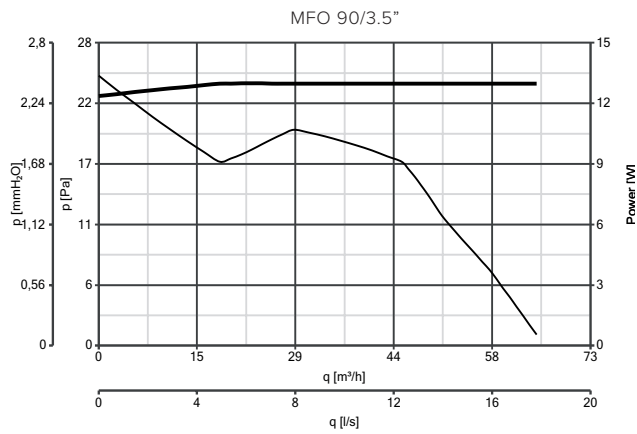

#### PERFORMANCE CURVES







## CONTROLLER

MODELS	DESCRIPTION	CODE	PRODUCT
	<b>C 1.5</b> - Electronic speed controller 1.5 A	12966	11143 - 11145 - 11147
	<b>SCB KIT</b> - Built-in controller adaptor for C 1.5	22481	12966

## ACCESSORIES ON REQUEST

MODELS	DESCRIPTION	CODE	PRODUCT	
	<b>SF KIT</b> - Ceiling kit	90 - 100	22162	11143 - 11144 - 11145 - 11146
		120	22163	11147 - 11148

## APPLICATIONS



## PUNTO GHOST RANGE

In-line axial fans **LONG LIFE 30.000 h**



Design: F. Trabucco & Associates



Suitable for installation in walls, ceilings/false ceilings, lofts, internal walls.

- **10 models:** from Ø 90 to 150 available with or without timer.
- Can be used as temperature blenders in adjacent rooms.
- Motor with shielded poles and ball bearings (30.000 h guaranteed continuous operation) with thermal cut-out. Except codes (11110- 11111 -11116-11117).
- Complies with the requirements of Part F1 of the Building Regulations even when connected on 3 m flexible aluminium duct (with 2 x 90° bends).
- Protection rating: IPX4.
- Insulation class: II □.

### TECHNICAL DATA

MODELS	CODE		V~50HZ	W max	A max	RPM max	MAX AIRFLOW		MAX PRESSURE		Lp dB(A) 3m max	MAX °C	KG
	BASIC	TIMER					m³/h	l/s	mmH <sub>2</sub> O	Pa			
MG 90/3.5"	11110	11111	220-240	18	0,10	2450	65	18	2,1	21	38	40	0,40
MG 100/4" LL	11100	11101	220-240	18	0,10	2415	80	22,2	2,6	25	39	40	0,43
MGK 100/4" LL	11106	-	220-240	18	0,10	2415	80	22,2	2,6	25	39	40	0,90
MG 120/5"	11116	-	220-240	20	0,12	2250	160	44	4,5	44	43	50	0,56
MG 120/5" LL	11102	11103	220-240	20	0,12	2250	160	44,4	4,5	44	43	50	0,56
MG 150/6"	11117	-	220-240	30	0,18	2200	89	89	7,0	69	48	50	0,80
MG 150/6" LL	11104	11105	220-240	30	0,18	2200	88,9	88,9	7,0	69	48	50	0,80



## PUNTO GHOST RANGE | TECHNICAL DATA FOR REGULATION N° 1254/2014/UE

	UNIT OF MEASURE	MG 90/3.5" MG 100/4"	MG 120/5"	MFO 150/6"
Supplier's name or trade mark	-	Vortice	Vortice	Vortice
Specific Energy Consumption class SEC in average climate zone	-	NA*	NA*	NA*
Specific Energy Consumption class SEC average		-5,4	-7,6	-10,0
Specific Energy Consumption class SEC cold	kWh/m <sup>2</sup> year	-18,8	-21,0	-23,4
Specific Energy Consumption class SEC warm		2,2	0,0	-2,4
Declared typology	-	RVU-U*	RVU-U*	RVU-U*
Type of drive	-	NA	NA	NA
Type of heat recovery system HRS	-	none	none	none
Thermal efficiency of heat recovery at reference air flow	%	NA*	NA*	NA*
Maximum flow rate	m <sup>3</sup> /h	77	157	311
Electric power input of the fan drive, including any motor control equipment, at maximum flow rate	W	13,7	20,5	25,0
Sound power level LWA	LWA [DB(A)]	60	64	69
Reference flow rate	m <sup>3</sup> /s	0,0150	0,0305	0,0605
Reference pressure difference	Pa	14	18	30
SPI	W/(m <sup>3</sup> /h)	0,24861	0,18471	0,11484
Control factor CTRL	-	1	1	1
Control typology	-	manual	manual	manual
Maximum internal leakage rates	%	NA	NA	NA
Maximum external leakage rates	%	NA	NA	NA
Mixing rate	-	NA	NA	NA
Position and description of visual filter warning	-	NA	NA	NA
Airflow sensitivity to pressure variations at + 20 Pa and - 20 Pa	-	NA	NA	NA
Indoor/outdoor air tightness	m <sup>3</sup> /h	NA	NA	NA
Annual electricity consumption (AEC)	kWh electricity/year	343	255	158
AHS average Annual heating saved		1397	1397	1397
AHS cold Annual heating saved	kWh primary energy/year	2732	2732	2732
AHS warm Annual heating saved		632	632	632

\* RVU-U: Unit Ventilation Residential - Unidirectional

\*\* NRVU-U: Unit Ventilation Non Residential - Unidirectional

\*\*\* MSD: Multi-Speed Drive

NA: Not applicable



## RESIDENTIAL VENTILATION

PUNTO GHOST RANGE

### DIMENSIONS

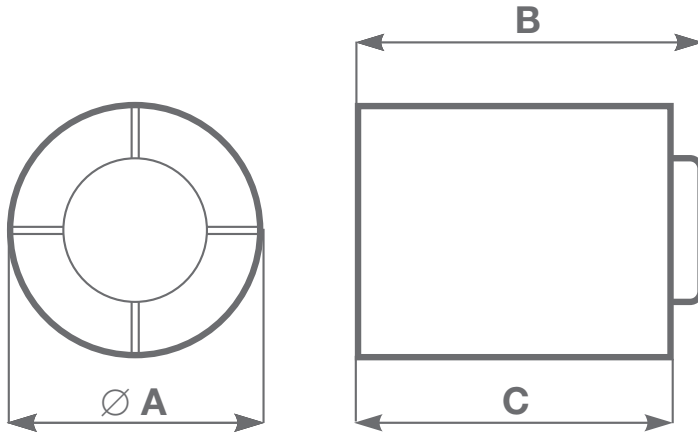

MODELS	$\varnothing A$	B	C
MG 90/3.5"	92.5	92	89
MG 90/3.5" T	92.5	96.5	89
MG 120/5"	119	103	100
MG 150/6"	155	110	107

Dimensions (mm)

### PERFORMANCE CURVES

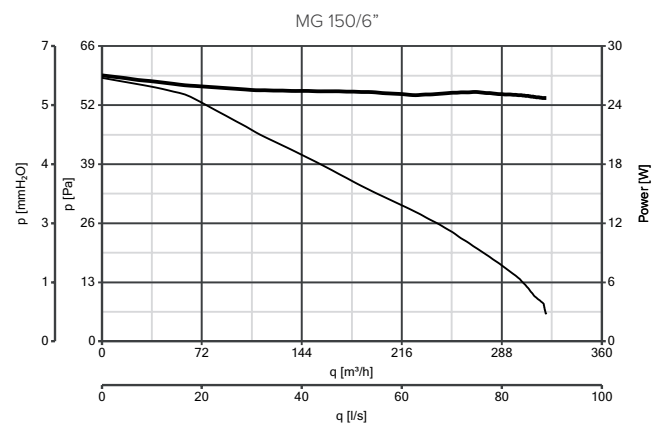
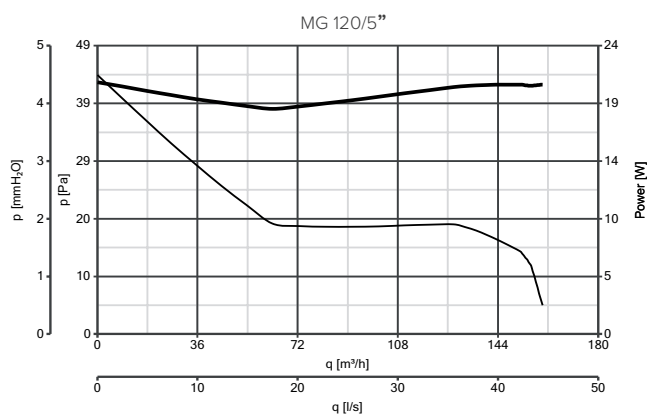
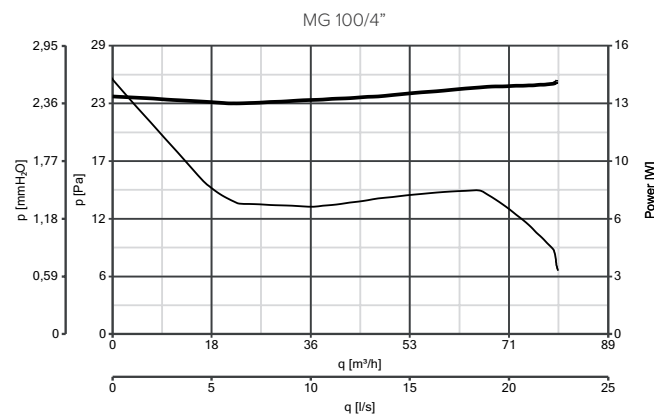
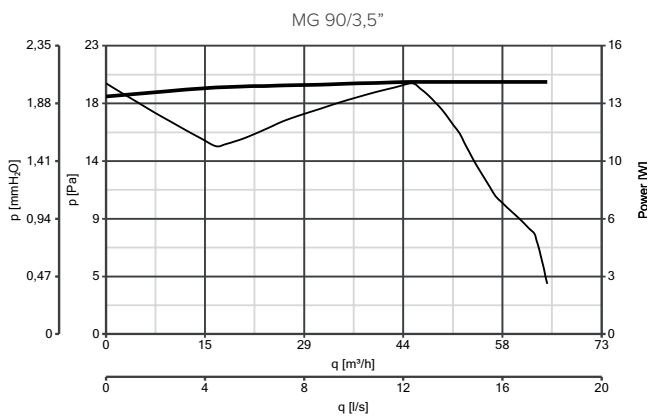



— Power consumption — Delivery







## CONTROLLER

MODELS	DESCRIPTION	CODE	PRODUCT
	<b>C 1.5</b> - Electronic speed controller 1.5 A	12966	11110 - 11100 - 11116 - 11102 - 11117 - 11104
	<b>SCNRB</b> - Electronic speed controller built-in	12971	11110 - 11116 - 11117
	<b>SCB KIT</b> - Built-in controller adaptor for C 1.5	22481	12966

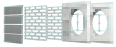
## ACCESSORIES ON REQUEST

MODELS	DESCRIPTION	CODE	PRODUCTS	
	<b>LOFT MOUNTING BRACKETS</b>	Ø 90/100	22259	11110 - 11111 - 11100 - 11101
		Ø 120/5	22260	11116 - 11102 - 11103
		Ø 150/6	22261	11117 - 11104 - 11105
	<b>INSTALLATION KIT COMP.</b>	Ø 90/3	22265	11110 - 11111
		Ø 100/4	22140	11100 - 11101
		Ø 120/5	22263	11116
		Ø 150/6	22264	11117
	<b>FLEXIBLE DUCT</b>	Ø 90/100	22250	11110 - 11111
		Ø 120/5	22251	11116 - 11102 - 11103
		Ø 150/6	22252	11117 - 11104 - 11105
	<b>TELESCOPIC WALL LINER</b>	Ø 100/4	22256	11110 - 11111
		Ø 120/5	22257	11116 - 11102 - 11103
		Ø 150/6	22258	11117 - 11104 - 11105

## APPLICATIONS

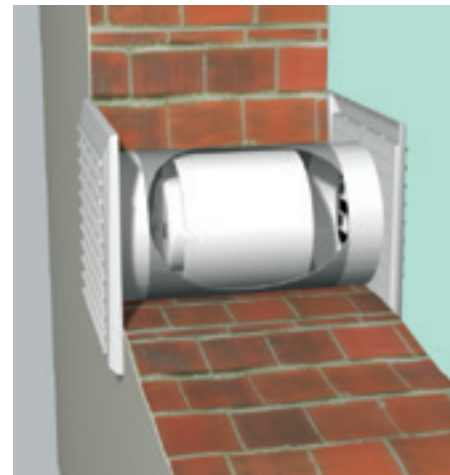



## PUNTO EVO FLEXP RANGE

Wall axial fans **LONG LIFE 30.000h**

Suitable for wall and ceiling installation; designed for stile air extraction through walls or short ducts.

- **2 versions: Standard, Timer (T).**
- 2 nominal diameters: 100 mm and 120 mm.
- For intermittent or continuous ventilation.
- Front panel, motor holder and integrated backdraught shutter made of ABS thermoplastic shockproof and anti-UV resin.
- Helico-centrifugal mixed-flow impellers made of PP resin.
- Impellers and motor holder specifically designed for high performance, low power consumption and low noise emissions.
- Integrated butterfly backdraught shutter designed to prevent unwanted air inflows when the appliance is switched off.
- Designed to provide a low environmental impact, using recyclable materials and following the new “Design for Disassembly” technique to achieve easy and environmentally friendly disposal of components.
- Typical wall/panel, false wall, ceiling and false ceiling installations.
- The reduced mounting depth makes it ideal to fit even when the installation space is limited due to the proximity of elbow bends (90°).
- Unique anch stylish design.
- Compact size.
- Reduced depth: 61,5 mm for models Ø 100 e 71 mm for models Ø 120.
- Protection rating: IPX5 and IP45.
- Insulation class: II

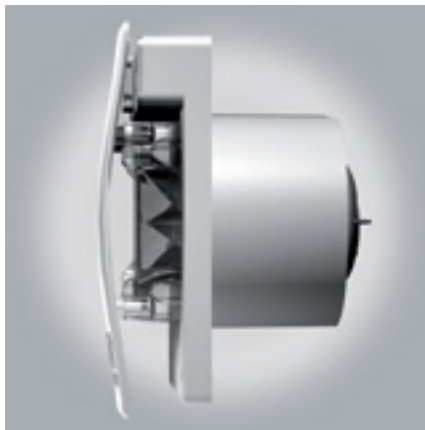

### TECHNICAL DATA

MODELS	CODE		V~50HZ	W max	A max	RPM max	MAX AIRFLOW		MAX PRESSURE		Lp dB(A) 3m max	MAX °C	KG
	BASIC	TIMER					m³/h	l/s	mmH <sub>2</sub> O	Pa			
MEX 100/4" LL 1S	11313	11314	230	9	0.052	2175	90	25	4	39.23	26.9	50	0.60
MEX 120/5" LL 1S	11333	11334	230	13	0.095	2075	175	48.6	5	49.04	32.3	50	0.77



## PUNTO EVO FLEXP RANGE | TECHNICAL DATA FOR REGULATION N° 1254/2014/UE

	UNIT OF MEASURE	MF 90/3.5"	MF 150/6"
Supplier's name or trade mark	-	Vortice	Vortice
Specific Energy Consumption class SEC in average climate zone	-	NA*	NA*
Specific Energy Consumption class SEC average	-	-9,9	-10,0
Specific Energy Consumption class SEC cold	kWh/m <sup>2</sup> year	-23,2	-23,4
Specific Energy Consumption class SEC warm	-	-2,2	-2,4
Declared typology	-	RVU-U*	RVU-U*
Type of drive	-	NA	NA
Type of heat recovery system HRS	-	none	none
Thermal efficiency of heat recovery at reference air flow	%	NA*	NA*
Maximum flow rate	m <sup>3</sup> /h	87	168
Electric power input of the fan drive, including any motor control equipment, at maximum flow rate	W	8,0	14,1
Sound power level LWA	LWA [DB(A)]	47	53
Reference flow rate	m <sup>3</sup> /s	0,0169	0,0327
Reference pressure difference	Pa	21	19
SPI	W/(m <sup>3</sup> /h)	0,11823	0,11480
Control factor CTRL	-	1	1
Control typology	-	manual	manual
Maximum internal leakage rates	%	NA	NA
Maximum external leakage rates	%	NA	NA
Mixing rate	-	NA	NA
Position and description of visual filter warning	-	NA	NA
Airflow sensitivity to pressure variations at + 20 Pa and - 20 Pa	-	NA	NA
Indoor/outdoor air tightness	m <sup>3</sup> /h	NA	NA
Annual electricity consumption (AEC)	kWh electricity/year	163	158
AHS average Annual heating saved	-	1397	1397
AHS cold Annual heating saved	kWh primary energy/year	2732	2732
AHS warm Annual heating saved	-	632	632

\* RVU-U: Unit Ventilation Residential - Unidirectional

\*\* NRVU-U: Unit Ventilation Non Residential - Unidirectional

\*\*\* MSD: Multi-Speed Drive

NA: Not applicable



## RESIDENTIAL VENTILATION

### PUNTO EVO FLEXO RANGE

## DIMENSIONS

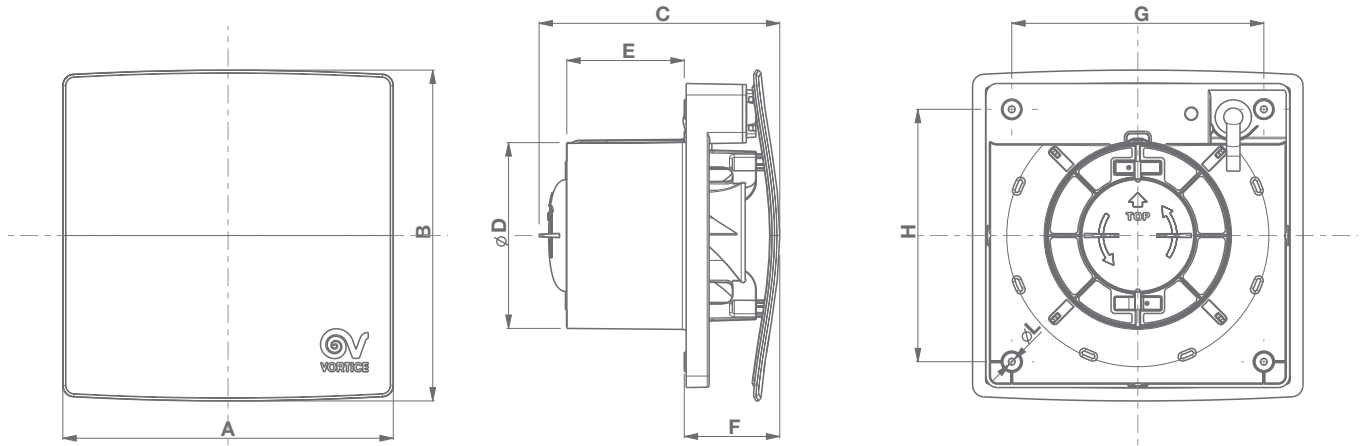

MODELS	A	B	C	Ø	E	F	G	H	Ø L
MEX 100/4" LL 1S	173	173	126	98	61.5	50	132	132	3.5
MEX 100/4" LL 1S T	173	173	126	98	61.5	50	132	132	3.5
MEX 120/5" LL 1S	193	193	138	119	71	53	152	152	3.5
MEX 120/5" LL 1S T	193	193	138	119	71	53	152	152	3.5

Dimensions (mm)

## PERFORMANCE CURVES

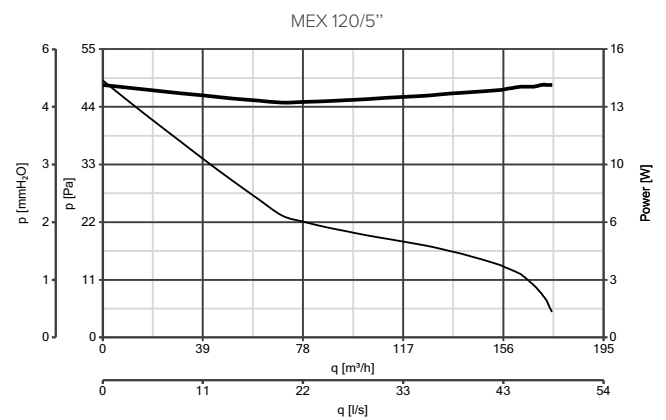
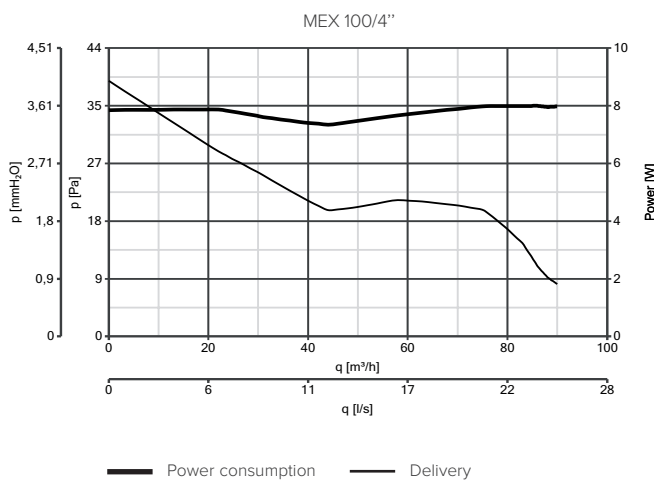





EXPLODED VIEW

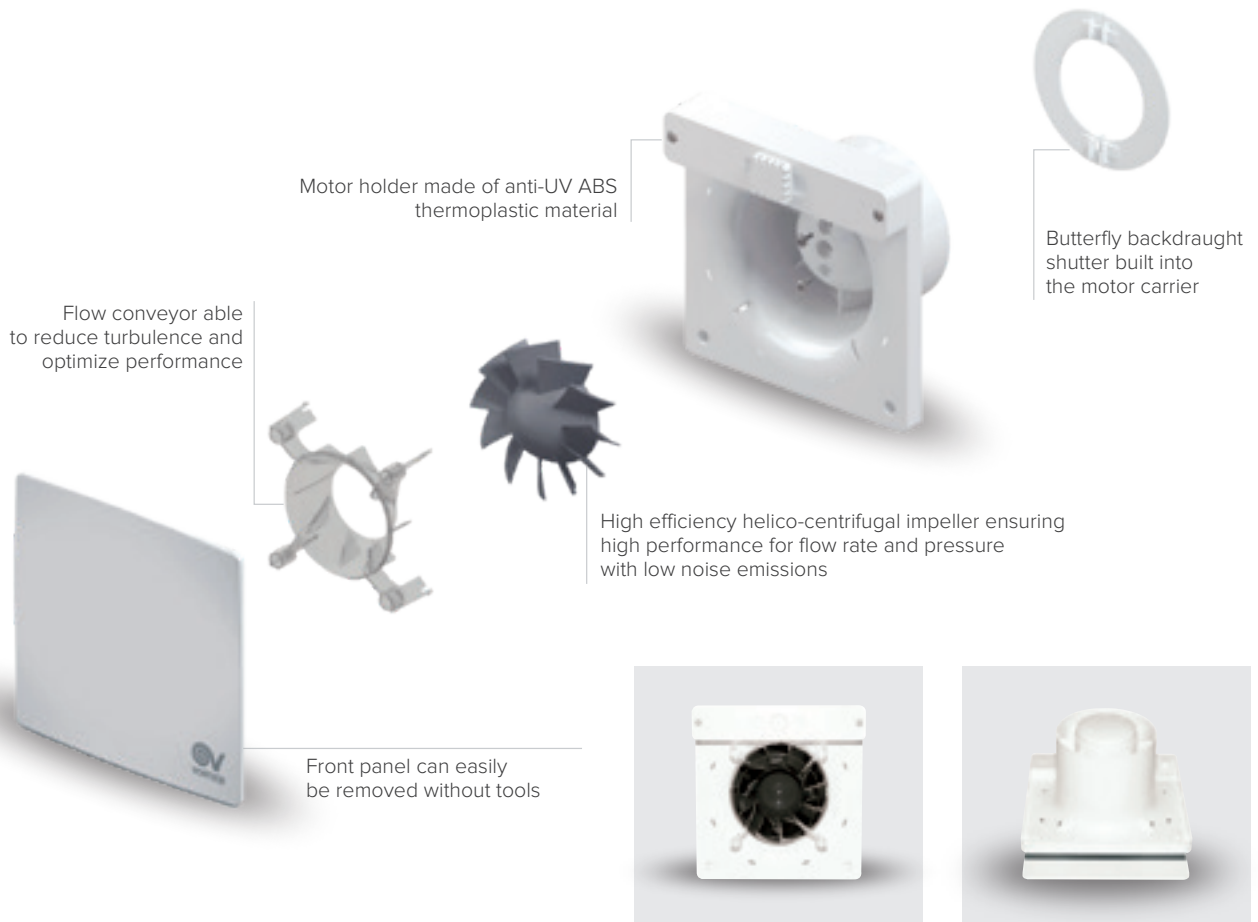

APPLICATIONS





## PUNTO EVO RANGE

Wall axial fans **LONG LIFE 30.000h**

Suitable for wall and ceiling installation; designed for stile air extraction through walls or short ducts.

- **5 versions: Standard, Timer (T), Advanced Timer (TP), Humidity control (HCS), Infrared motion sensor (PIR).**
- 2 nominal diameters: 100 mm and 120 mm.
- 2 speeds.
- Shock-proof, UV resistant, ABS made enclosures.
- Helico-centrifugal mixed-flow impellers made of PP resin.
- Motor carriers with airfoil flow straighteners.
- Aerodynamically optimised impellers and internal geometry.
- Impellers and motor holder specifically designed for high performance, low power consumption and low noise emissions.
- Integrated butterfly backdraught shutter designed to prevent unwanted air inflows when the appliance is switched off.
- Long-life ball-bearing motors guaranteed for 30,000 hours continuous trouble-free operation.
- Designed to provide a low environmental impact, using recyclable materials and following the new “Design for Disassembly” technique to achieve easy and environmentally friendly disposal of components.
- Short mounting depth, ideal for installations close to 90° (elbow) pipe bends.
- Protection rating: IPX5 and IP45 suitable for installation in zone 1 of bathroom.
- Insulation class: II



IPX5

### RANGE

Diam.	<b>BASIC LONG LIFE</b>	<b>TIMER LONG LIFE</b>	<b>TIMER EVOLUTO LONG LIFE</b>	<b>TP HCS LONG LIFE</b>	<b>PIR LONG LIFE</b>
Ø100	11260 ME 100/4" LL	11264 ME 100/4" LL T	11261 ME 100/4" LL TP	11262 ME 100/4" LL TP HCS	11263 ME 100/4" LL PIR
Ø120	11270 ME 120/5" LL	11274 ME 120/5" LL T	11271 ME 120/5" LL TP	11272 ME 120/5" LL TP HCS	11273 ME 120/5" LL PIR



The **Basic version** is equipped with a 2-speed PCB.



The **Timer version** is equipped with a PCB for time-lagged appliance switch-off. The appliance is preset for a minimum operating time of 3 minutes; it is possible to adjust the timer from approximately 3 to 20 minutes. The appliance switches on automatically straight after the light is switched on and continues to run for the set time after the light is switched off. During installation you can choose the operating speed of the appliance, min. or max. speed.



The **Timer Plus version** is equipped with a PCB that enables time-lagged switching on and/or off of the appliance at the min. or max. speed. The time lag for switching on and off, as well as the operating speed, are set during installation. In addition, the appliance can run automatic switch-on daily cycles. This function is very useful to avoid the concentration of relative humidity in environments rarely inhabited.



The **Timer PIR version** features a PCB with an infrared presence sensor able to automatically activate the appliance whenever anyone is in its range of action. In addition, thanks to the Timer, the PCB enables time-lagged switch-off, for a preset time adjustable from 3 to 20 minutes. The switch-off time, as well as the operating speed (min. or max. speed), can be set during installation.



The **Timer Plus HCS version** features a PCB with a Timer Evoluto and a humidity sensor able to automatically activate the appliance whenever the ambient relative humidity values exceed the preset limit or when it grows rapidly. The factory preset value is 70%. The relative humidity value can in any case be set by the installer on 4 values: 60%, 70%, 80%, 90%. The PCB moreover permits time-lagged switching on and/or off at the min. or max. speed.

## TECHNICAL DATA

MODELS	V~50HZ	W min/max	A min/max	RPM min/max	MAX AIRFLOW		MAX PRESSURE		Lp dB(A)* 3m min/max	MAX °C	KG
					m³/h min/max	l/s min/max	mmH <sub>2</sub> O min/max	Pa min/max			
ME 100/4" LL	220-240	5 9	0.039 0.052	1700 2240	65 95	18.1 26.4	2.5 4.7	22.52 46.09	20.8 26.9	50	0.60
ME 120/5" LL	220-240	10 13	0.060 0.080	1490 2070	120 175	33.3 48.6	2.3 5.0	22.56 49.04	24.0 32.3	50	0.77



## RESIDENTIAL VENTILATION

### PUNTO EVO RANGE

#### PUNTO EVO RANGE | TECHNICAL DATA FOR REGULATION N° 1254/2014/UE

	UNIT OF MEASURE	ME 100/4" LL	MF 150/6"
Supplier's name or trade mark	-	Vortice	Vortice
Specific Energy Consumption class SEC in average climate zone	-	NA*	NA*
Specific Energy Consumption class SEC average	-	-9.9	-9.9
Specific Energy Consumption class SEC cold	kWh/m <sup>2</sup> year	-23.2	-23.3
Specific Energy Consumption class SEC warm	-	-2.2	-2.3
Declared typology	-	RVU-U*	RVU-U*
Type of drive	-	NA	NA
Type of heat recovery system HRS	-	none	none
Thermal efficiency of heat recovery at reference air flow	%	NA	NA
Maximum flow rate	m <sup>3</sup> /h	93	168
Electric power input of the fan drive, including any motor control equipment, at maximum flow rate	W	8.1	14.5
Sound power level LWA	LWA [DB(A)]	68	53
Reference flow rate	m <sup>3</sup> /s	0.0181	0.0327
Reference pressure difference	Pa	22	18
SPI	W/(m <sup>3</sup> /h)	0.11828	0.11735
Control factor CTRL	-	1	1
Control typology	-	manual	manuale
Maximum internal leakage rates	%	NA	NA
Maximum external leakage rates	%	NA	NA
Mixing rate	-	NA	NA
Position and description of visual filter warning	-	NA	NA
Airflow sensitivity to pressure variations at + 20 Pa and - 20 Pa	-	NA	NA
Indoor/outdoor air tightness	m <sup>3</sup> /h	NA	NA
Annual electricity consumption (AEC)	kWh electricity/year	163	162
AHS average Annual heating saved	-	1397	1397
AHS cold Annual heating saved	kWh primary energy/year	2732	2732
AHS warm Annual heating saved	-	632	632

\* RVU-U: Unit Ventilation Residential - Unidirectional

\*\* NRVU-U: Unit Ventilation Non Residential - Unidirectional

\*\*\* MSD: Multi-Speed Drive

NA: Not applicable



DIMENSIONS

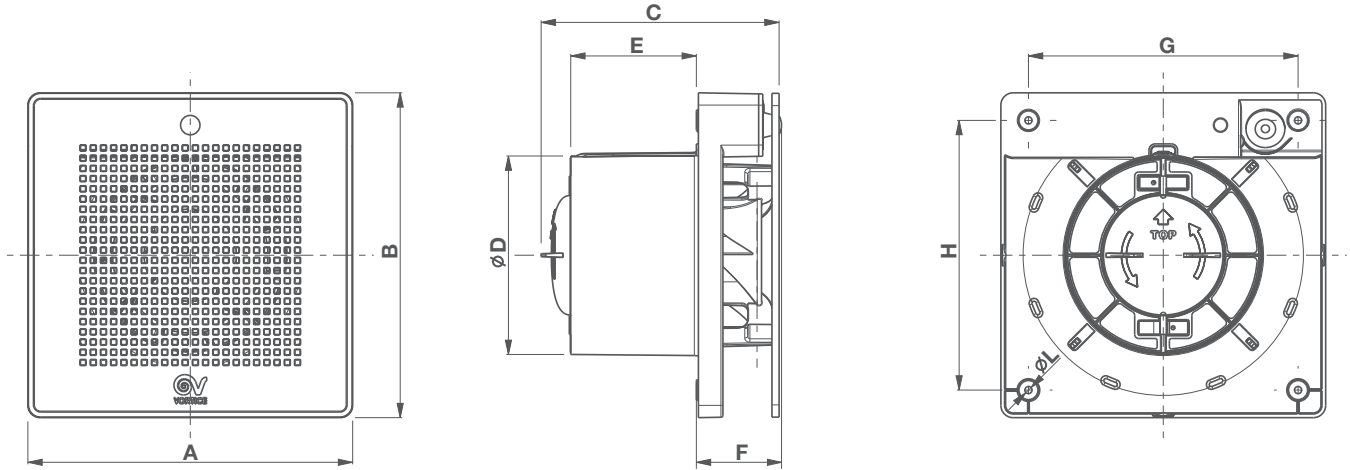

MODELS	A	B	C	Ø	E	F	G	H	ØL
ME 100/4" LL	159	159	116.5	98	61.5	40.5	132	132	3.5
ME 100/4" LL PIR	159	159	118	98	61.5	42	132	132	3.5
ME 120/5" LL	179	179	127	118	71	42.5	152	152	3.5
ME 120/5" LL PIR	179	179	128.5	118	71	44	152	152	3.5

Dimensions (mm)

EXPLODED VIEW

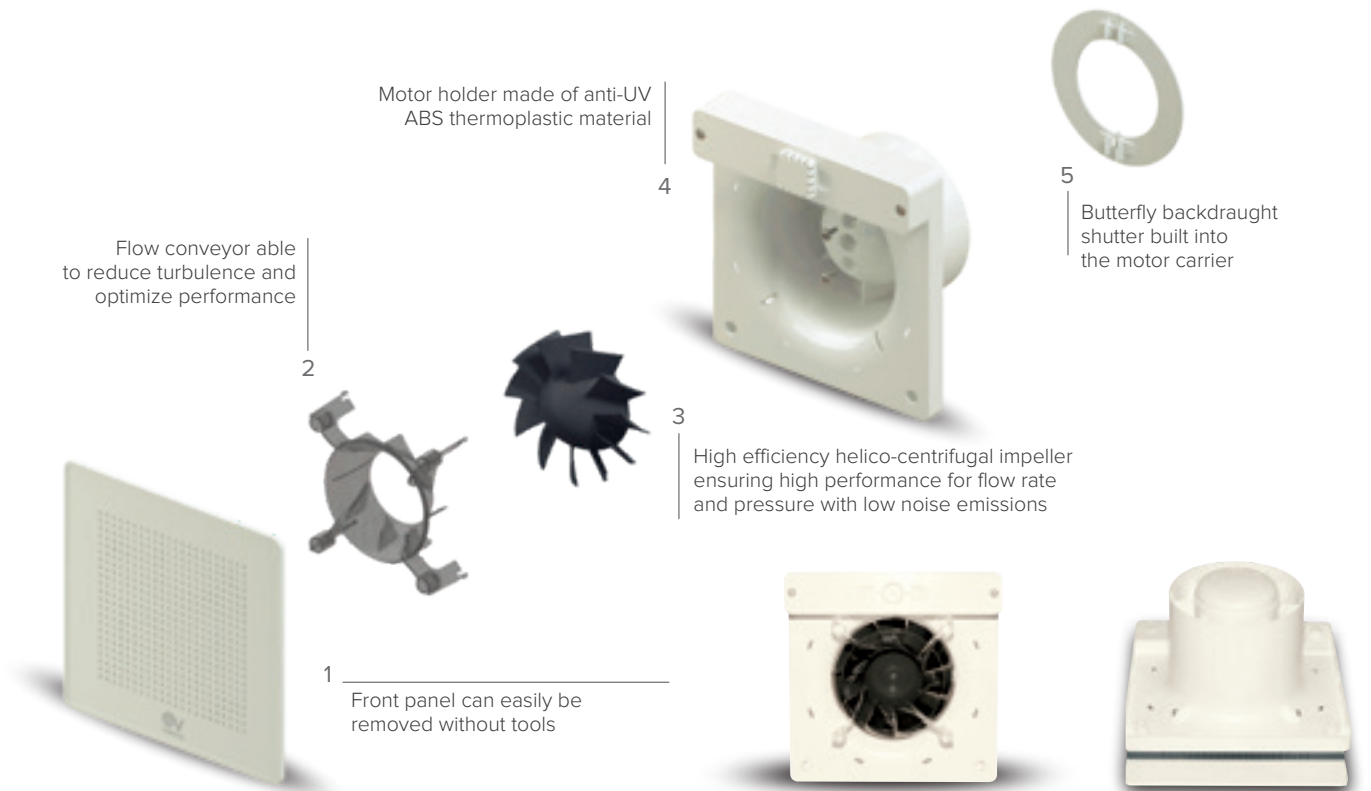



## RESIDENTIAL VENTILATION

PUNTO EVO RANGE

### PERFORMANCE CURVES

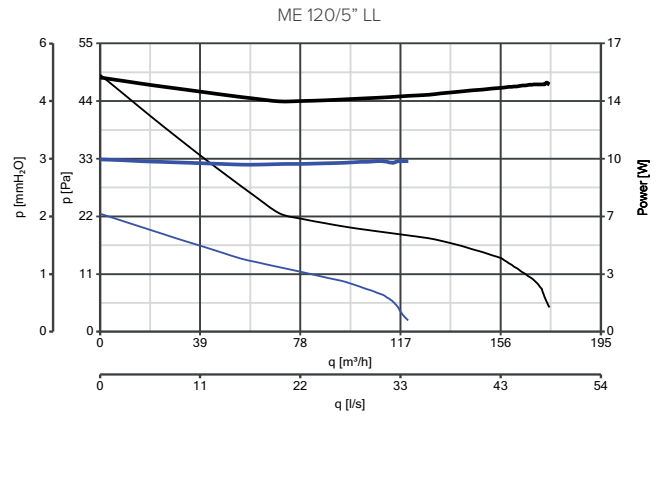
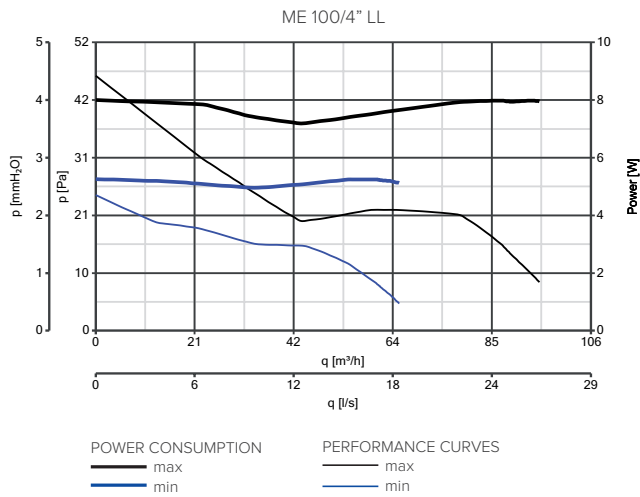

### APPLICATIONS







APPLICATIONS

---

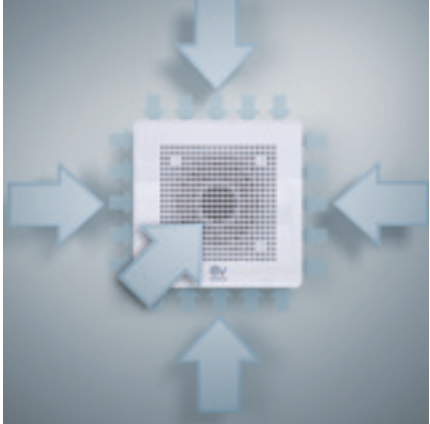



## PUNTO EVO ES RANGE

Wall axial fans energy savings **LONG LIFE 30.000 h**

Suitable for wall and ceiling installation; designed for stille air extraction through walls or short ducts.

- **2 nominal diameters:** 100 mm, 120 mm.
- Short mounting depth, ideal for installations close to 90° (elbow) pipe bends.
- ES versions equipped with brushless EC motors for even lower power consumption. Two-speed motors, with ball bearings, guaranteed for 30,000 hours of continuous operation.
- Impact-resistant ABS enclosures with anti-UV treatment.
- Aerodynamically optimised impellers and internal geometry.
- Impellers and motor holder specifically designed for high performance, low power consumption and low noise emissions.
- Safety-certified by IMQ in accordance with the applicable international standards.
- ES models allow to activate, during installation, Timer function; in detail, 3 distinct operating modes are available, depending on electrical connection:
  - continuous operating at minimum speed;
  - continuous operating at maximum speed;
  - Two speed operation: the product runs at minimum speed; by selecting maximum speed (eg. turning on the light), it switches to maximum speed and then returns to minimum speed 6 minutes after the light has been switched off.
- Integrated butterfly backdraught shutter designed to prevent unwanted air inflows when the appliance is switched off.
- Protection rating: IPX 5 and IP45 suitable for installation in zone 1 of bathroom.
- Insulation class: II



**IPX5**

### TECHNICAL DATA

MODELS	CODE	V~50HZ	W min/max	A min/max	RPM min/max	MAX AIRFLOW		MAX PRESSURE		Lp dB(A)* 3m min/max	Lw dB(A) 3m min/max	MAX °C**	KG
						m³/h min/max	l/s min/max	mmH <sub>2</sub> O min/max	Pa min/max				
ME 100/4" ES	11268	230	2.1 3.6	0.030 0.041	1680 2280	65 95	18.1 26.4	2.7 5.1	26.5 50.0	21.0 27.8	41.5 48.3	50	0.64
ME 120/5" ES	11269	230	3.3 7.0	0.040 0.068	1680 2150	130 180	36.1 50.0	3.6 5.8	35.3 56.9	26.2 33.3	46.7 53.8	50	0.80



PUNTO EVO ES RANGE | TECHNICAL DATA FOR REGULATION N° 1254/2014/UE

	UNIT OF MEASURE	ME 100/4" ES	ME 120/5" ES
Supplier's name or trade mark	-	Vortice	Vortice
Specific Energy Consumption class SEC in average climate zone	-	NA	NA
Specific Energy Consumption class SEC average	-	-12.1	-12.3
Specific Energy Consumption class SEC cold	kWh/m <sup>2</sup> year	-25.5	-25.6
Specific Energy Consumption class SEC warm	-	-4.5	-4.6
Declared typology	-	RVU-U*	RVU-U*
Type of drive	-	NA	NA
Type of heat recovery system HRS	-	none	none
Thermal efficiency of heat recovery at reference air flow	%	NA*	NA*
Maximum flow rate	m <sup>3</sup> /h	89	175
Electric power input of the fan drive, including any motor control equipment, at maximum flow rate	W	3.5	6.6
Sound power level LWA	LWA [DB(A)]	48	54
Reference flow rate	m <sup>3</sup> /s	0.0173	0.0340
Reference pressure difference	Pa	21	20
SPI	W/(m <sup>3</sup> /h)	0.05297	0.04980
Control factor CTRL	-	1	1
Control typology	-	manual	manual
Maximum internal leakage rates	%	NA	NA
Maximum external leakage rates	%	NA	NA
Mixing rate	-	NA	NA
Position and description of visual filter warning	-	NA	NA
Airflow sensitivity to pressure variations at + 20 Pa and - 20 Pa	-	NA	NA
Indoor/outdoor air tightness	m <sup>3</sup> /h	NA	NA
Annual electricity consumption (AEC)	kWh electricity/year	73	69
AHS average Annual heating saved	-	1397	1397
AHS cold Annual heating saved	kWh primary energy/year	2732	2732
AHS warm Annual heating saved	-	632	632

\* RVU-U: Unit Ventilation Residential - Unidirectional  
 \*\* NRVU-U: Unit Ventilation Non Residential - Unidirectional  
 \*\*\* MSD: Multi-Speed Drive  
 NA: Not applicable

DIMENSIONS

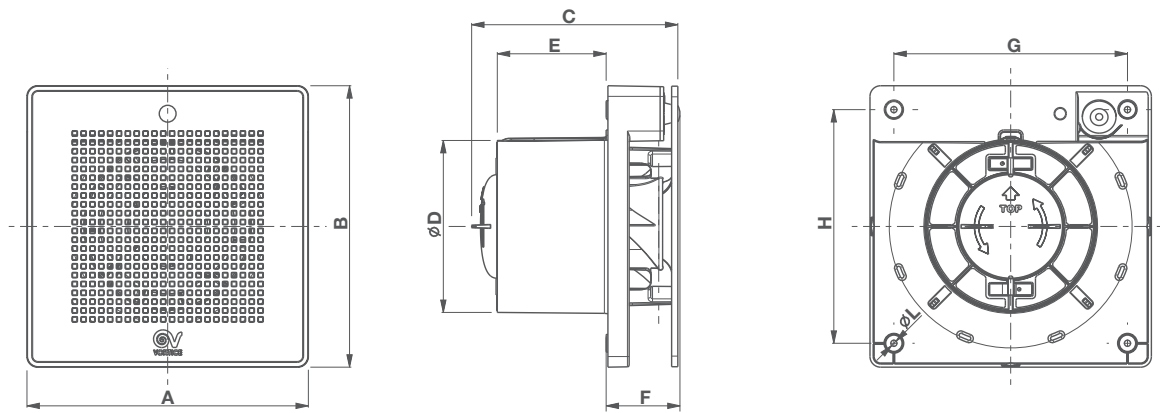

MODELS	A	B	C	ØD	E	F	G	H	ØL
ME 100/4" ES	159	159	132	98	77.5	40.5	132	132	3.5
ME 120/5" ES	179	179	138	118	81	42.5	152	152	3.5

Dimensions (mm)



## RESIDENTIAL VENTILATION

PUNTO EVO ES RANGE

### EXPLODED VIEW

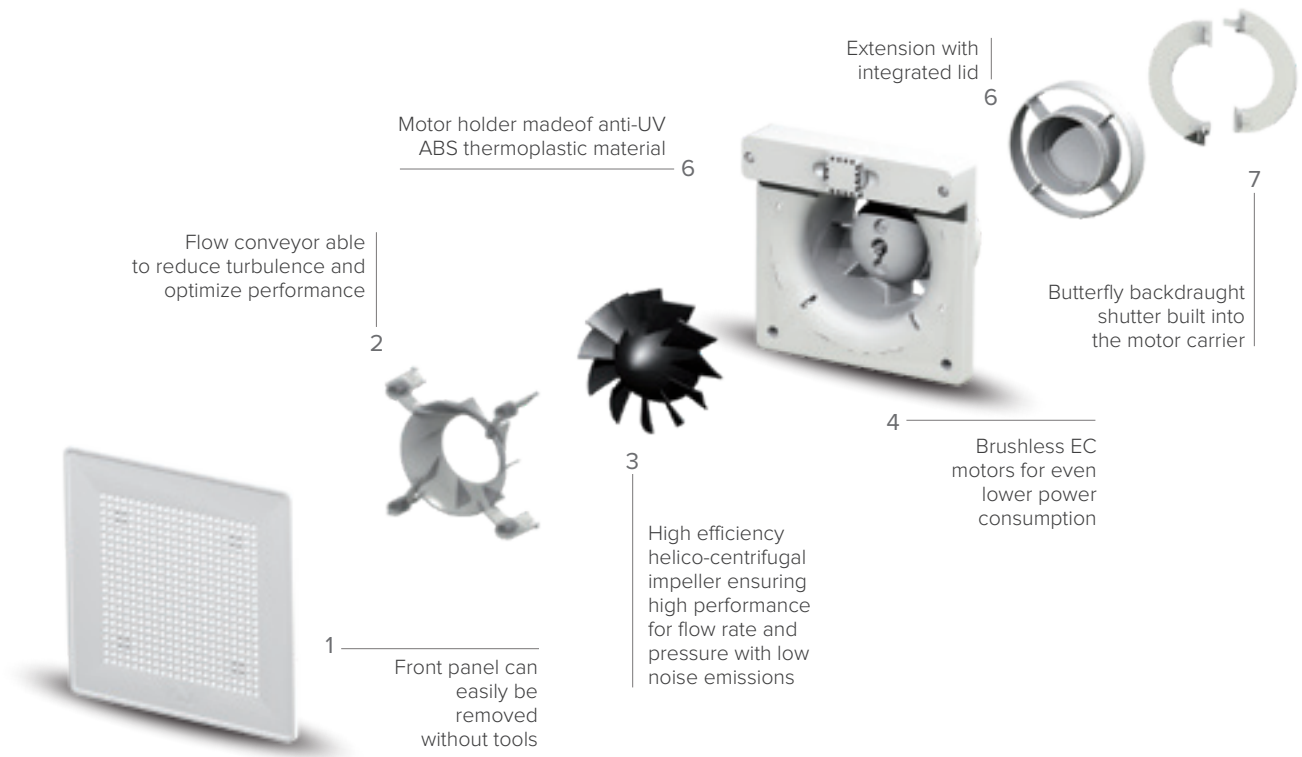

### PERFORMANCE CURVES

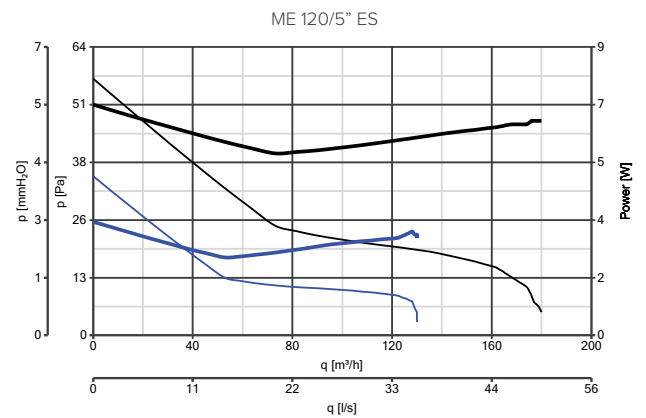
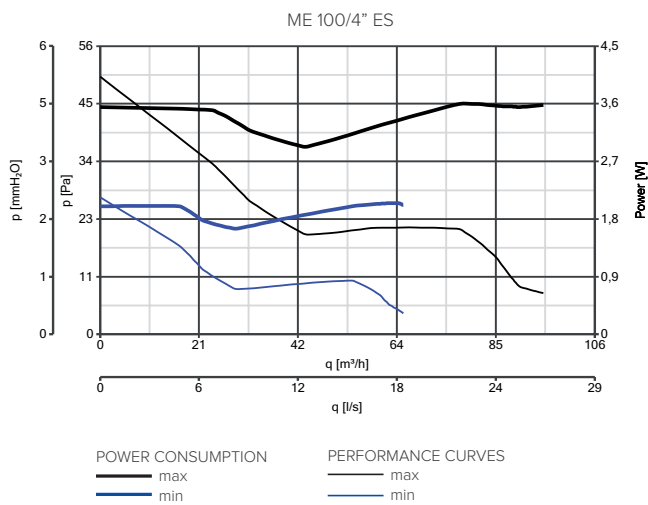



APPLICATIONS

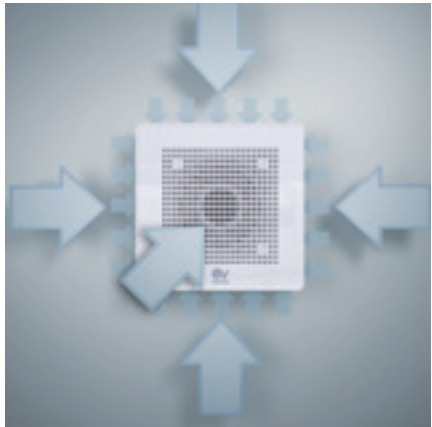



## PUNTO EVO GOLD RANGE

Wall axial fans **LONG LIFE 30.000h**

Suitable for wall and ceiling installation; designed for stile air extraction through walls or short ducts.

- **2 versions: Standard, Timer (T).**
- 1 nominal diameters: 100 mm.
- 2 speeds.
- The GOLD versions of PUNTO EVO feature a stylish metallic mirror finish in four colour nuances (Pink, Yellow, Black and White Gold) obtained through advanced technologies, providing an attractive and distinctive style, durability and wear resistance.
- Short mounting depth, ideal for installations close to 90° (elbow) pipe bends.
- Long-life ball-bearing motors guaranteed for 30,000 hours continuous trouble-free operation.
- Shock-proof, UV resistant, ABS made enclosures.
- Helico-centrifugal mixed-flow impellers made of PP resin.
- Motor carriers with airfoil flow straighteners.
- Impellers and motor holder specifically designed for high performance, low power consumption and low noise emissions.
- Designed to provide a low environmental impact, using recyclable materials and following the new “Design for Disassembly” technique to achieve easy and environmentally friendly disposal of components.
- Integrated butterfly backdraught shutter designed to prevent unwanted air inflows when the appliance is switched off.
- Protection rating: IP45.
- Insulation class: II



### RANGE

		PUNTO EVO <i>Gold</i> YELLOW GOLD	PUNTO EVO <i>Gold</i> PINK GOLD	PUNTO EVO <i>Gold</i> BLACK GOLD	PUNTO EVO <i>Gold</i> WHITE GOLD
Diam.					
Ø100	<b>BASIC LONG LIFE</b>	<b>11306</b> ME 100/4" LL	<b>11307</b> ME 100/4" LL	<b>11308</b> ME 100/4" LL	<b>11309</b> ME 100/4" LL
	<b>TIMER LONG LIFE</b>	<b>11316</b> ME 100/4" LL T	<b>11317</b> ME 100/4" LL T	<b>11318</b> ME 100/4" LL T	<b>11319</b> ME 100/4" LL T



The **Basic version** is equipped with a 2-speed PCB.



The **Timer version** is equipped with a PCB for time-lagged appliance switch-off. The appliance is preset for a minimum operating time of 3 minutes; it is possible to adjust the timer from approximately 3 to 20 minutes. The appliance switches on automatically straight after the light is switched on and continues to run for the set time after the light is switched off. During installation you can choose the operating speed of the appliance, min. or max. speed.





## TECHNICAL DATA

MODELS	V~50HZ	W min/max	A min/max	RPM min/max	MAX AIRFLOW		MAX PRESSURE		Lp dB(A)* 3m min/max	Lw dB(A) 3m min/max	MAX °C**	KG
					m³/h min/max	l/s min/max	mmH₂O min/max	Pa min/max				
ME 100/4" LL	220-240	5 9	0.039 0.052	1700 2240	65 95	18.1 26.4	2.5 4.7	24.52 46.09	20.8 26.9	41.3 47.4	50	0.60

## PUNTO EVO GOLD RANGE | TECHNICAL DATA FOR REGULATION N° 1254/2014/UE

	UNIT OF MEASURE	ME 100/4" LL
Supplier's name or trade mark	-	Vortice
Specific Energy Consumption class SEC in average climate zone	-	NA
Specific Energy Consumption class SEC average		-9.9
Specific Energy Consumption class SEC cold	kWh/m² year	-23.2
Specific Energy Consumption class SEC warm		-2.2
Declared typology	-	RVU-U*
Type of drive	-	NA*
Type of heat recovery system HRS	-	assente
Thermal efficiency of heat recovery at reference air flow	%	NA*
Maximum flow rate	m³/h	93
Electric power input of the fan drive, including any motor control equipment, at maximum flow rate	W	8.1
Sound power level LWA	LWA [DB(A)]	68
Reference flow rate	m³/s	0.0181
Reference pressure difference	Pa	22
SPI	W/(m³/h)	0.11828
Control factor CTRL	-	1
Control typology	-	manuale
Maximum internal leakage rates	%	NA
Maximum external leakage rates	%	NA
Mixing rate	-	NA
Position and description of visual filter warning	-	NA
Airflow sensitivity to pressure variations at + 20 Pa and - 20 Pa	-	NA
Indoor/outdoor air tightness	m³/h	NA
Annual electricity consumption (AEC)	kWh electricity/year	163
AHS average Annual heating saved		1397
AHS cold Annual heating saved	kWh primary energy/year	2732
AHS warm Annual heating saved		632

\* RVU-U: Unit Ventilation Residential - Unidirectional

\*\* NRVU-U: Unit Ventilation Non Residential - Unidirectional

\*\*\* MSD: Multi-Speed Drive

NA: Not applicable



## RESIDENTIAL VENTILATION

PUNTO EVO GOLD RANGE

### DIMENSIONS

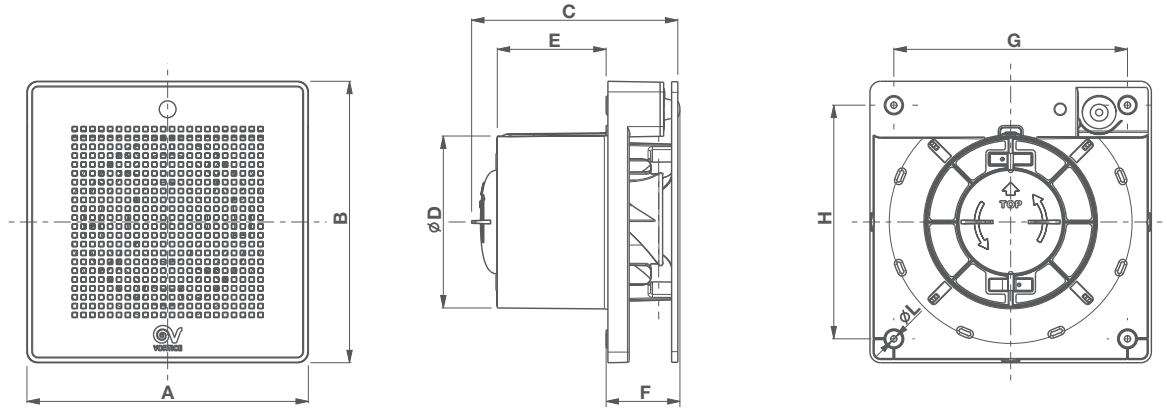

MODELS	A	B	C	Ø D	E	F	G	H	Ø L
ME 100/4" LL	159	159	116.5	98	61.5	40.5	132	132	3.5

Dimensions (mm)

### PERFORMANCE CURVES

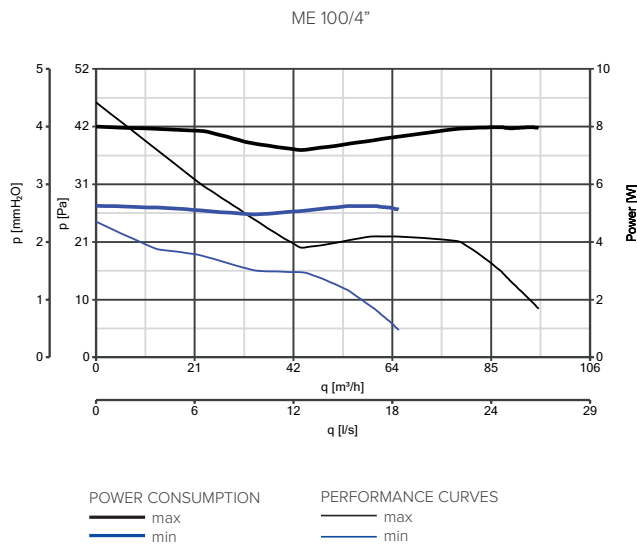



APPLICATIONS

---





## VORTICE VARIO RANGE

Wall/window axial fans **LONG LIFE 80.000 h**

Supply to improve the quality of air we breathe daily in any domestic or commercial environment: dwellings, shops & cafes, sports centers gyms, restaurants, public houses, offices, schools, community halls and many more...

- **10 models:** from 150 to 300 diameter, long life, Pull Cord and automatic reversible.
- The Vortice Vario models are among the best of their category in terms of performance and low energy consumption thanks to highly efficient impellers.
- Structural components in UV resistant ABS, internal components from shock resistant PS.
- Quick and easy to install.
- Extremely low noise emission.
- Vario fans are carefully designed to provide a low environmental impact, using recyclable materials and following the new "Design for Disassembly" technique to provide easy and environmentally friendly disposal of components.
- Data and performances IMQ Performance certified
- Protection rating: IPX4.
- Insulation class: II

Design: F. Trabucco & Associates



### TECHNICAL DATA

MODELS	CODE	V~50/60HZ	W max	A max	RPM max	MAX AIRFLOW		Lp dB(A)* 3m max	MAX °C**	KG
						m³/h	l/s			
VORTICE 150/6" P	12611	220-240	18	0.10	1340	235	65.3	37.5	50	2.07
VORTICE 150/6" AR	12612	220-240	25	0.11	1340 <sup>(1)</sup> 2040 <sup>(2)</sup>	235 <sup>(1)</sup> 150 <sup>(2)</sup>	65.3 <sup>(1)</sup> 41.7 <sup>(2)</sup>	37.5	50	2.07
VORTICE 150/6" AR LL S	14615	220-240	35	0.17	2110 <sup>(2)</sup> 2520 <sup>(1)</sup>	380 <sup>(2)</sup> 215 <sup>(1)</sup>	105.6 <sup>(2)</sup> 59.7 <sup>(1)</sup>	49.6	50	2.07
VORTICE 150/6" P LL S	12614	220-240	32	0.16	2110	380	105.6	46.9	50	2.07
VORTICE 230/9" P	12451	220-240	22	0.10	790	480	133	35.6	50	3.45
VORTICE 230/9" AR	12452	220-240	26	0.13	790 <sup>(1)</sup> 1080 <sup>(2)</sup>	480 <sup>(1)</sup> 310 <sup>(2)</sup>	133 <sup>(1)</sup> 86 <sup>(2)</sup>	35.6	50	3.45
VORTICE 230/9" P LL S	12454	220-240	32 (50 HZ) 38 (60 HZ)	0.18	1200	700	194.4	43.6	50	3.45
VORTICE 230/9" AR LL S	12455	220-240	35 (50 HZ) 40 (60 HZ)	0.19	1200 <sup>(1)</sup> 1300 <sup>(2)</sup>	700 <sup>(1)</sup> 370 <sup>(2)</sup>	194.4 <sup>(1)</sup> 102.8 <sup>(2)</sup>	43.6	50	3.45
VORTICE 300/12" AR	12412	220-240	45	0.21	840 <sup>(1)</sup> 1085 <sup>(2)</sup>	1050 <sup>(1)</sup> 700 <sup>(2)</sup>	292 <sup>(1)</sup> 194.4 <sup>(2)</sup>	40.2	50 (50 Hz) 40 (60 Hz)	6.13
VORTICE 300/12" AR LL S	12415	220-240	75 (50 Hz) 90 (60 Hz)	0.41	1215 <sup>(1)</sup> 1280 <sup>(2)</sup>	1650 <sup>(1)</sup> 920 <sup>(2)</sup>	458.3 <sup>(1)</sup> 255.6 <sup>(2)</sup>	53.6	50 (50 Hz) 40 (60 Hz)	6.13

<sup>(1)</sup> Intake - <sup>(2)</sup> Extract

Legend: P= Pull Cord, A= Automatic, R= Reversible, LL= Long Life, S= Performance boost.



DIMENSIONS

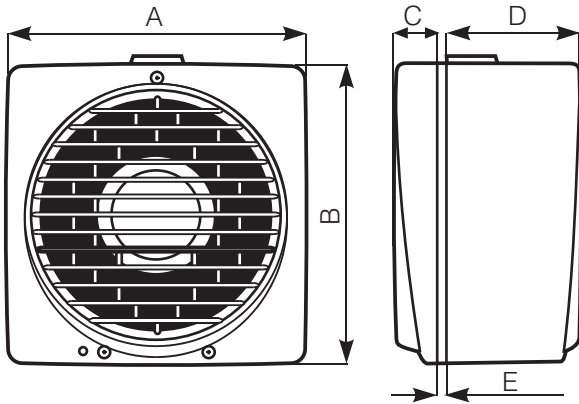

MODELS	A	B	C	D	E MIN/MAX	HOLE DIA Ø
VORTICE 150/6"	215	218	31	97.5	2/38	185÷190
VORTICE 230/9"	294	297	31	130	2/38	257÷262
VORTICE 300/12"	390	393	31	147	2/38	324÷329

Dimensions (mm)

PERFORMANCE CURVES

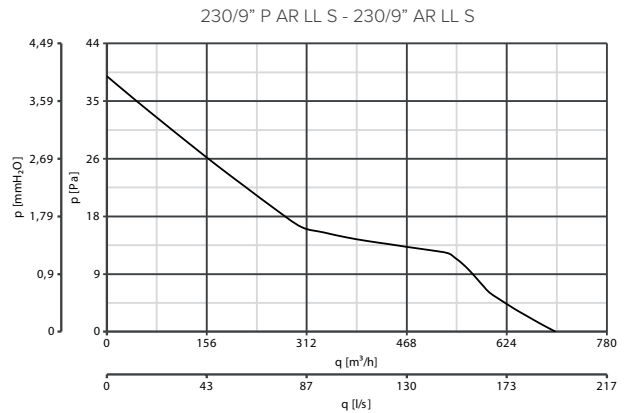
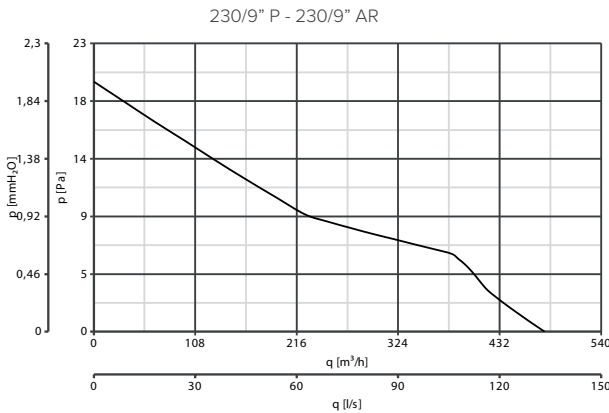
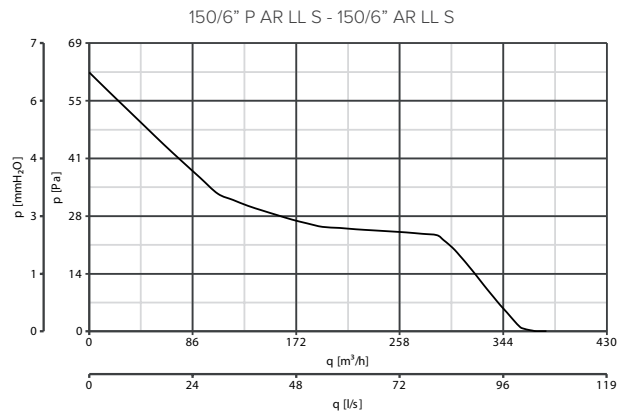
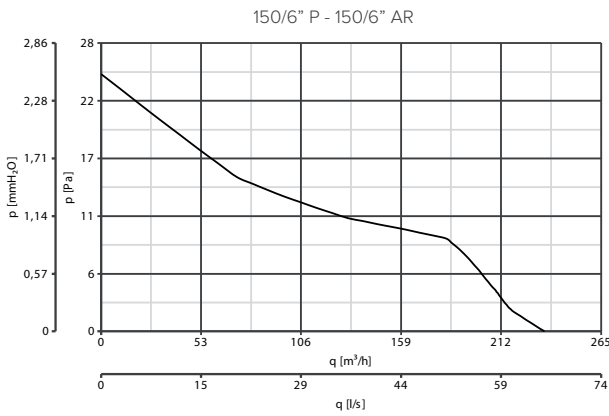

— Power consumption — Delivery



## RESIDENTIAL VENTILATION



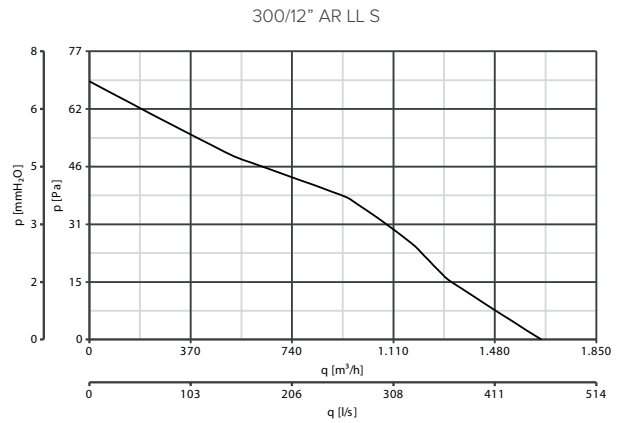
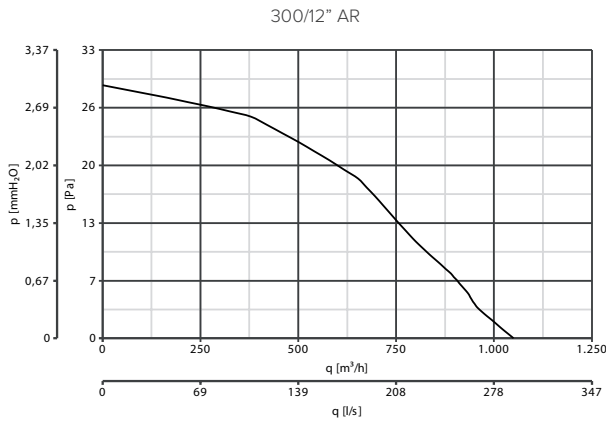

VORTICE VARIO RANGE

### PERFORMANCE CURVES





— Power consumption — Delivery

### CONTROLLER

MODELS	DESCRIPTION	CODE	PRODUCTS
	<b>CR5N</b> - Reversible 5 speeds controller	12941	All products (not for code 12611 - 12451)
	<b>CREN</b> - Reversible 5 speeds controller	12944	All products (not for code 12611 - 12451)
	<b>C TEMP</b> - Environmental sensor for temperature	12992	All products (not for code 12611 - 12451)
	<b>C SMOKE</b> - Environmental sensor for air quality	12993	All products (not for code 12611 - 12451)
	<b>C HCS</b> - Environmental sensor for humidity	12994	All products (not for code 12611 - 12451)
	<b>C PIR</b> - Passive infrared sensor	12998	All products (not for code 12611 - 12451)
	<b>C TIMER</b> - Adjustable over-run timer	12999	All products (not for code 12611 - 12451)



### ACCESSORIES ON REQUEST

MODELS	DESCRIPTION	CODE	PRODUCTS
	150/6"	13021	12611 - 12612 - 12615 - 12614
	230/9"	13022	12451 - 12452 - 12454 - 12455
	300/12"	13023	12412 - 12415
	150/6"	13024	12611 - 12612 - 12615 - 12614
	230/9"	13025	12451 - 12452 - 12455
	300/12"	13026	12412 - 12415
	<b>KIT MU</b> - Wall mounting kit with rods	13018	12611 - 12612 - 12451 - 12452 - 12455 12412 - 12415





ACCESSORIES ON REQUEST

MODELS	DESCRIPTION	CODE	PRODUCTS
	KIT TE - Roof cowl/wind baffle kit	150/6"	13001 12611 - 12612 - 12615 - 12614
		230/9"	13002 12451 - 12452 - 12454 - 12455
		300/12"	13003 12412 - 12415
	KIT SA - Darkroom cowl kit	13004	12451 - 12452 - 12455 - 12613 - 12616 12653 - 12456 - 12413 - 12416



**SINGLE AND DOUBLE-GLAZED WINDOW**

Models	Code	Kit required (code)	thickness min/max
150/6" P	12611	none	2-38
150/6" AR	12612		
150/6" P LL S	12614		
150/6" AR LL S	12615		
230/9" P	12451		
230/9" AR	12452		
230/9" P LL S	12454		
230/9" AR LL S	12455		
300/12" AR	12412		
300/12" AR LL S	12415		



**WINDOW/PANEL MOUNTING WITH EXTERNAL COWL AS A WIND BAFFLE**

Models	Code	Kit required (code)
150/6" P	12611	13001
150/6" AR	12612	
150/6" P LL S	12614	
150/6" AR LL S	12615	
230/9" P	12451	13002
230/9" AR	12452	
230/9" P LL S	12454	
230/9" AR LL S	12455	
300/12" AR	12412	13003
300/12" AR LL S	12415	



**KIT VV - DOUBLE-GLAZED (OPENING) WINDOW**

Models	Code	Kit required (code)	thickness min/max
150/6" P	12611	13021	
150/6" AR	12612		
150/6" P LL S	12614		
150/6" AR LL S	12615		
230/9" P	12451	13022	30-43
230/9" AR	12452		
230/9" AR LL S	12455		
230/9" P LL S	12454	13023	
300/12" AR	12412		
300/12" AR LL S	12415		



**WALL MOUNTING FOR REMOTE APPLICATION\***

Models	Code	Kit required (code)
150/6" AR	12612	13003 + 13018 + 2 items 13027
150/6" AR LL S	16615	
230/9" AR	12452	13002 + 13018 + 2 items 13028
230/9" AR LL S	12455	
300/12" AR	12412	13003 + 13018 + 2 items 13029
300/12" AR LL S	12611	

\* duct not included



**KIT FF - DOUBLE (OPENING) WINDOW SECONDARY-GLAZED**

Models	Code	Kit required (code)	thickness min/max
150/6" P	12611	13024	
150/6" AR	12612		
150/6" P LL S	12614		
150/6" AR LL S	12615		
230/9" P	12451	13025	230-300
230/9" AR	12452		
230/9" AR LL S	12455		
230/9" P LL S	12454	13026	
300/12" AR	12412		
300/12" AR LL S	12415		



**PANEL/WALL MOUNTING WITH DARKROOM COWL**

Models	Code	Kit required (code)
230/9" P	12451	glass = 13004 wall = 13004 + 13018
230/9" P LL S	12454	
230/9" AR	12452	
230/9" AR LL S	12455	

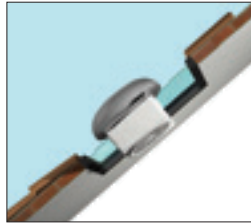

**KIT TE - ROOF COWL/WIND BAFFLE KIT**

Models	Code	Kit required (code)
150/6" P	12612	13001
150/6" P LL S	12614	
150/6" AR LL S	12615	
230/9" AR	12452	13002
230/9" AR LL S	12455	
230/9" P LL S	12454	
300/12" AR	12412	13003
300/12" AR LL S	12415	



**KIT MU - WALL MOUNTING**

Models	Code	Kit required (code)	thickness min/max
150/6" P	12611		
150/6" AR	12612		
150/6" P LL S	12614		
150/6" AR LL S	12615		
230/9" P	12451	13018	300
230/9" AR	12452		
230/9" AR LL S	12455		
230/9" P LL S	12454		
300/12" AR	12412		
300/12" AR LL S	12415		



**ROOF MOUNTING WITH EXTERNAL COWL AS A WIND BAFFLE**

Models	Code	Kit required (code)	thickness min/max
150/6" P	12611	13001 + 13018	
150/6" AR	12612		
150/6" P LL S	12614		
150/6" AR LL S	12615		
230/9" P	12451		
230/9" AR	12452		
230/9" AR LL S	12455	13002 + 13018	300
230/9" P LL S	12454		
300/12" AR	12412	13003 + 13018	
300/12" AR LL S	12415		



Design: F. Trabucco &amp; Associates



## VORTICE VARIO I RANGE

 Flush mounted axial fans **LONG LIFE 30.000 h**

Supply to improve the quality of air we breathe daily in any domestic or commercial environment: dwellings, shops & cafes, sports centers, gyms, restaurants, public houses, offices, schools, community halls and many more...

- **6 models:** from 150 to 300 diameters, Long life, Pull cord and automatic reversible.
- Flush mounting.
- The Vortice Vario models are among the best of their category in terms of performance and low energy consumption thanks to highly efficient impellers.
- Body made of shock-resistant ABS plastic anti-UV.
- Structural components in UV resistant ABS, internal components from shock resistant PS. Le giranti in polipropilene caricato con fibre di vetro.
- Quick and easy to install.
- Extremely low noise emission.
- Vario fans are carefully designed to provide a low environmental impact, using recyclable materials and following the new "Design for Disassembly" technique to provide easy and environmentally friendly disposal of components.
- Highly efficient impellers.
- Model for installation on glass/panel/wall.
- Ceiling installation and wall installation.
- Data and performances IMQ Performance certified.
- Protection rating: IPX4.
- Insulation class: II .

### TECHNICAL DATA

MODELS	CODE	V~50/60HZ	W max	A max	RPM max	MAX AIRFLOW		Lp dB(A)* 3m max	MAX °C**	KG
						m³/h	l/s			
VORTICE 150/6" ARI	12613	220-240	25	0.11	1330 <sup>(1)</sup> 1880 <sup>(2)</sup>	220 <sup>(1)</sup> 130 <sup>(2)</sup>	61.1 <sup>(1)</sup> 36.1 <sup>(2)</sup>	38.2	50	2.52
VORTICE 150/6" ARI LL S	12616	220-240	35	0.17	2080 <sup>(1)</sup> 2460 <sup>(2)</sup>	350 <sup>(1)</sup> 200 <sup>(2)</sup>	97.2 <sup>(1)</sup> 55.6 <sup>(2)</sup>	49.1	50	2.52
VORTICE 230/9" ARI	12453	220-240	26	0.13	810 <sup>(1)</sup> 1080 <sup>(2)</sup>	450 <sup>(1)</sup> 300 <sup>(2)</sup>	125 <sup>(1)</sup> 83.3 <sup>(2)</sup>	35.7	50	3.88
VORTICE 230/9" ARI LL S	12456	220-240	35 (50 Hz) 40 (60 Hz)	0.19	1160 <sup>(1)</sup> 1260 <sup>(2)</sup>	680 <sup>(1)</sup> 350 <sup>(2)</sup>	188.9 <sup>(1)</sup> 97.2 <sup>(2)</sup>	45.3	50	3.88
VORTICE 300/12" ARI	12413	220-240	45	0.21	850 <sup>(1)</sup> 1150 <sup>(2)</sup>	1200 <sup>(1)</sup> 850 <sup>(2)</sup>	333.3 <sup>(1)</sup> 236.1 <sup>(2)</sup>	40.7	50 (50 Hz) 40 (60 Hz)	7.20
VORTICE 300/12" ARI LL S	12416	220-240	75 (50 Hz) 90 (60 Hz)	0.41	1230 <sup>(1)</sup> 1310 <sup>(2)</sup>	1750 <sup>(1)</sup> 1000 <sup>(2)</sup>	486.1 <sup>(1)</sup> 277.7 <sup>(2)</sup>	53.5	50 (50 Hz) 40 (60 Hz)	7.20

<sup>(1)</sup> Intake - <sup>(2)</sup> Extract

Legend: P= Pull Cord, A= Automatic, R= Reversibile, LL= Long Life, S= Performance boost.



DIMENSIONS

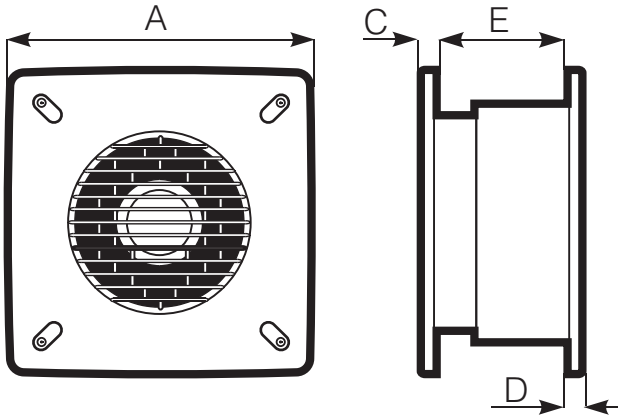

PRODOTTI	Ø	B	C	D	ØMOLE DIA
VORTICE 150/6" ARI	300	9.5	10.5	135	260÷265
VORTICE 230/9" ARI	400	10	11.0	180	335÷340
VORTICE 300/12"	495	10.5	11.5	210	435÷440

Quote in mm

PERFORMANCE CURVES

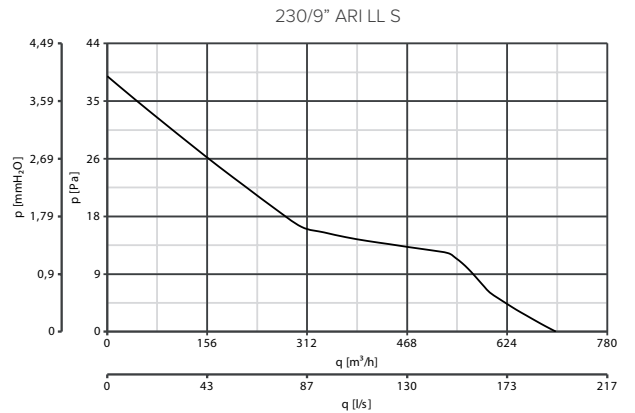
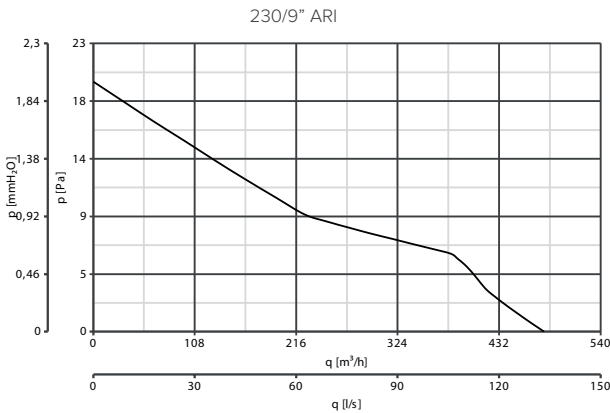
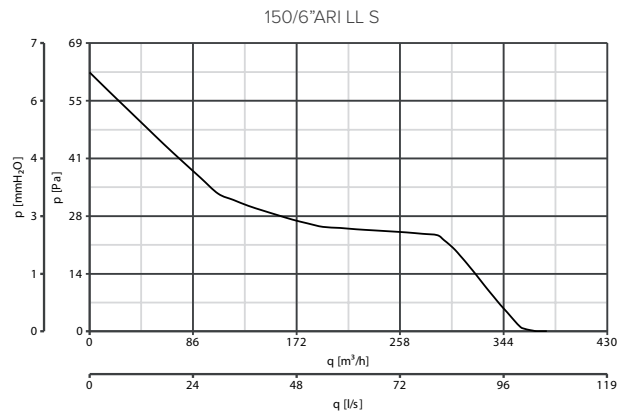
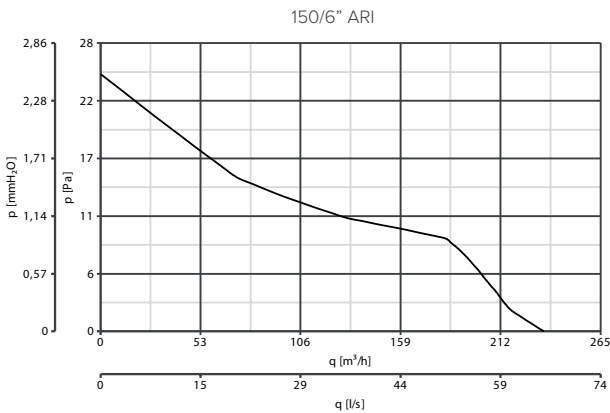

— Power consumption — Delivery







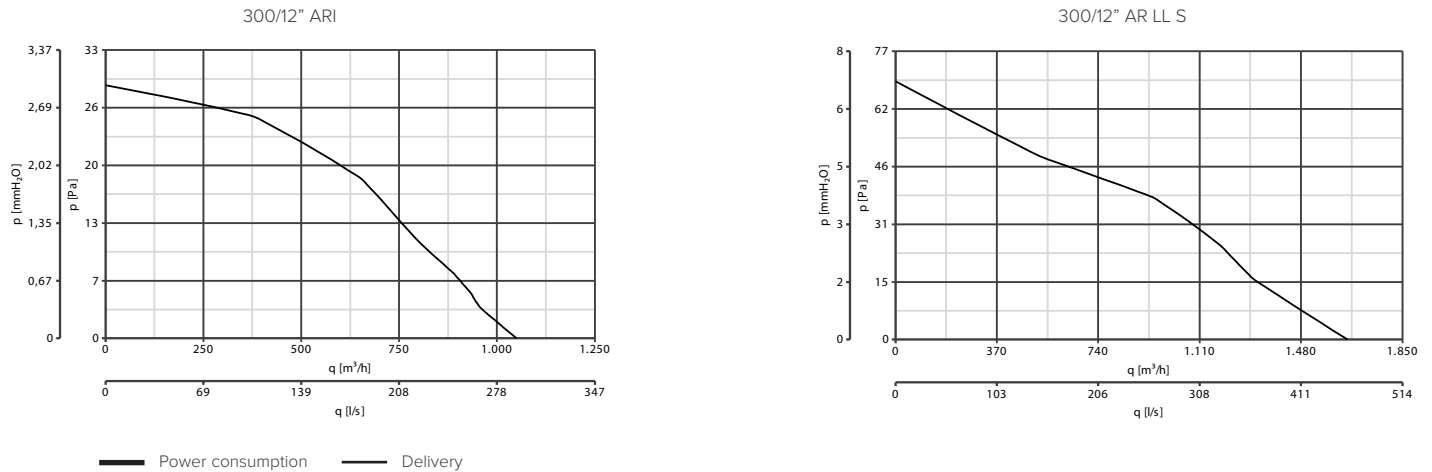

## RESIDENTIAL VENTILATION

VORTICE VARIO I RANGE



### PERFORMANCE CURVES



### CONTROLLER

MODELS	DESCRIPTION	CODE	PRODUCT
	<b>CR5N</b> - Reversible 5 speeds controller	12941	All products
	<b>CREN</b> - Reversible 5 speeds controller	12944	All products
	<b>C TEMP</b> - Environmental sensor for temperature	12992	All products
	<b>C SMOKE</b> - Environmental sensor for air quality	12993	All products
	<b>C HCS</b> - Environmental seonsor for humidity	12994	All products
	<b>C PIR</b> - Passive infrared sensor	12998	All products
	<b>C TIMER</b> - Adjustable over-run timer	12999	All products

### ACCESSORIES ON REQUEST

MODELS	DESCRIPTION	CODE	PRODUCT
	150/6"	13015	12616 - 12613
	230/9"	13016	12456 - 12653
	300/12"	13017	12416 - 12413
	150/6"	13027	12616 - 12613
	230/9"	13028	12456 - 12653
	300/12"	13029	12416 - 12413
	150/6"	13012	12616 - 12456 - 12613 - 12653
	230/9"		
	300/12"	13014	12413 - 12416



ACCESSORIES ON REQUEST



**BUILT-IN WALL MOUNTING**

Models	Code	Kit required (code)	thickness
150/6" ARI LL S	12616	none	135
150/6" ARI	12613		
230/9" ARI LL S	12456	none	180
230/9" ARI	12453		
300/12" ARI LL S	12416	none	210
300/12" ARI	12413		

**BUILT-IN DEEP WALL MOUNTING**

Models	Code	Kit required (code)	thickness min/max
150/6" ARI LL S	12616	13015	260-460
150/6" ARI	12613		
230/9" ARI LL S	12456	13016	320-500
230/9" ARI	12453		
300/12" ARI LL S	12416	13017	375-515
300/12" ARI	12413		

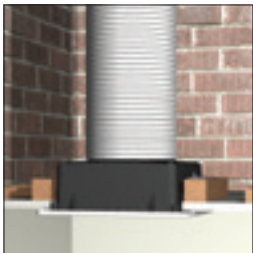

**BUILT-IN PANEL, CEILING AND FALSE CEILING MOUNTING\***

Models	Code	Kit required (code)
150/6" ARI LL S	12616	13012
150/6" ARI	12613	
230/9" ARI LL S	12456	13012
230/9" ARI	12453	
300/12" ARI LL S	12616	13014
300/12" ARI LL S	12616	

\* duct not included

**TELESCOPIC FRAME FOR WALL MOUNTED MODELS**

This frame is made of expanded polystyrene and facilitates wall mounting of the Vortice Vario series. Accessory included.

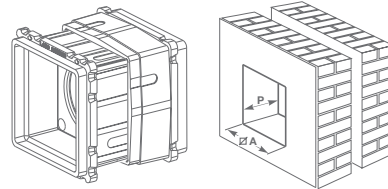

MODEL	∅ A	P (MIN)	P (MAX)
150/6"	325	220	330
230/9"	400	220	330
300/12"	500	220	330

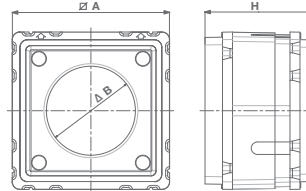

MODEL	A	∅B	H
3,217 MM	325	180	205-330
KIT IN 230/9"	400	260	205-330
KIT IN 300/12"	500	305	205-330

Number of required kits	150/6" AR Code 12612	150/6" ARI LL S Code 12615	150/6" P Code 12611	150/6" P LL S Code 12614	230/9" AR Code 12452	230/9" ARI LL S Code 12455	230/9" P Code 12451	230/9" P LL S Code 12454	300/12" AR Code 12412	300/12" ARI LL S Code 12415	150/6" ARI Code 12613	150/6" ARI LL S Code 12616	230/9" ARI Code 12453	230/9" ARI LL S Code 12456	300/12" ARI Code 12413	300/12" ARI LL S Code 12416
-------------------------	----------------------	----------------------------	---------------------	--------------------------	----------------------	----------------------------	---------------------	--------------------------	-----------------------	-----------------------------	-----------------------	----------------------------	-----------------------	----------------------------	------------------------	-----------------------------

**SINGLE-GLAZED WINDOW**

Wall	1	13018	13018	13018	13018	13018	13018	13018	13018	13018	13018						
Double-glazed (opening window)	1	13021	13021	13021	13021	13022	13022	13022	13022	13023	13023						
Double (opening) window secondary-glazing	1	13024	13024	13024	13024	13025	13025	13025	13025	13026	13026						
Window-mounted with darkroom cowl	1					13004	13004	13004	13004								
Window / panel mounted with external cowl	1	13001	13001	13001	13001	13002	13002	13002	13002	13003	13003						
Roof application	1	13001	13001	13001	13001	13002	13002	13002	13002	13003	13003						
Wall-mounted with external cowl	2	13001 13018	13001 13018	13001 13018	13001 13018	13002 13018	13002 13018	13002 13018	13002 13018	13003 13018	13003 13018						
Wall-mounted for remote application (duct not included)	1	13001 13018 13027x2	13001 13018 13027x2	13001 13018 13027x2	13001 13018 13027x2	13002 13018 13027x2	13002 13018 13027x2	13002 13018 13027x2	13002 13018 13027x2	13003 13018 13027x2	13003 13018 13027x2						

**BUILT-IN WALL MOUNTED**

Thin wall mounted for remote application (duct not included)	3	13001 13012 13018 13027	13001 13012 13018 13027	13001 13012 13018 13027	13001 13012 13018 13027	13002 13012 13018 13028	13002 13012 13018 13028	13002 13012 13018 13028	13002 13012 13018 13028	13003 13014 13018 13029	13003 13014 13018 13029						
Panel-mounted with darkroom cowl	1					13004	13004	13004	13004								
Wall-mounted with darkroom cowl	2					13018 13004	13018 13004	13018 13004	13018 13004								
Built-in deep wall mounted	1									13015	13015	13016	13016	13017	13017		
Panel - Ceiling - False ceiling	1										13012	13012	13012	13012	13014	13014	
Roof-mounted for remote application (duct not included)	3									13001 13027 13012	13001 13027 13012	13002 13028 13012	13002 13028 13012	13003 13029 13014	13003 13029 13014		
Built-in wall mounted for remote application (duct not included)	3									13012 13015 13027	13012 13015 13027	13012 13016 13028	13012 13016 13028	13014 13017 13029	13014 13017 13029		



Design: F. Trabucco - M. Vecchi



## K RANGE

In-line centrifugal fans for kitchen cabinet

Suitable for ventilation of up to two bathrooms or a single utility.

- **2 models.**
- Induction motor with thermal protection.
- Fan provides high air flow rate combined with pressures suitable for the application, when long ducts are used.
- The Axial K model also has directional flow to eliminate air turbulence.
- Two speeds (Angol K).
- Special anti-vibration gasket for silent operation.
- Protection grille on the intake port.
- Simplified internal and external maintenance and cleaning.
- Protection rating: IPX2.
- Insulation class: II □.



**Awards**  
1991 Italian Golden Compass  
honor award

### TECHNICAL DATA

MODELS	CODE	V~50HZ	W min/max	A min/max	RPM min/max	MAX AIRFLOW		MAX PRESSURE		Lp dB(A)* 3m min/max	MAX °C**	KG
						m <sup>3</sup> /h min/max	l/s min/max	mmH <sub>2</sub> O min/max	Pa min/max			
ANGOL K	10204	220-240	29 35	0.12 0.16	1410 2180	86 140	23.9 38.9	13.5 17	132 157	33 43	40	1.27
AXIAL K	10904	220-240	27	0.13	2560	135	37.5	17	167	41	40	1.20

\* Data refers to both speeds. Measurement taken in front of the intake port with outlet connected and unobstructed extraction. Conforms with ISO 3744 for noise and pressure levels.





K RANGE | TECHNICAL DATA FOR REGULATION N° 1254/2014/UE

	UNIT OF MEASURE	ANGOL K	AXIAL K
Supplier's name or trade mark	-	Vortice	Vortice
Specific Energy Consumption class SEC in average climate zone	-	NA	NA
Specific Energy Consumption class SEC average	-	-2.2	-1.8
Specific Energy Consumption class SEC cold	kWh/m <sup>2</sup> year	-10.9	-10.5
Specific Energy Consumption class SEC warm	-	10.1	10.5
Declared typology	-	RVU-U*	RVU-U*
Type of drive	-	NA	NA
Type of heat recovery system HRS	-	none	none
Thermal efficiency of heat recovery at reference air flow	%	NA	NA
Maximum flow rate	m <sup>3</sup> /h	75	78
Electric power input of the fan drive, including any motor control equipment, at maximum flow rate	W	29.2	27.0
Sound power level LWA	LWA [DB(A)]	62	64
Reference flow rate	m <sup>3</sup> /s	0.0146	0.0152
Reference pressure difference	Pa	82	129
SPI	W/(m <sup>3</sup> /h)	0.47619	0.48901
Control factor CTRL	-	1	1
Control typology	-	manual	manual
Maximum internal leakage rates	%	NA	NA
Maximum external leakage rates	%	NA	NA
Mixing rate	-	NA	NA
Position and description of visual filter warning	-	NA	NA
Airflow sensitivity to pressure variations at + 20 Pa and - 20 Pa	-	NA	NA
Indoor/outdoor air tightness	m <sup>3</sup> /h	NA	NA
Annual electricity consumption (AEC)	kWh electricity/year	597	613
AHS average Annual heating saved	-	1715	1715
AHS cold Annual heating saved	kWh primary energy/year	2732	2732
AHS warm Annual heating saved	-	632	632

\* RVU-U: Unit Ventilation Residential - Unidirectional  
 \*\* NRVU-U: Unit Ventilation Non Residential - Unidirectional  
 \*\*\* MSD: Multi-Speed Drive  
 NA: Not applicable

DIMENSIONS

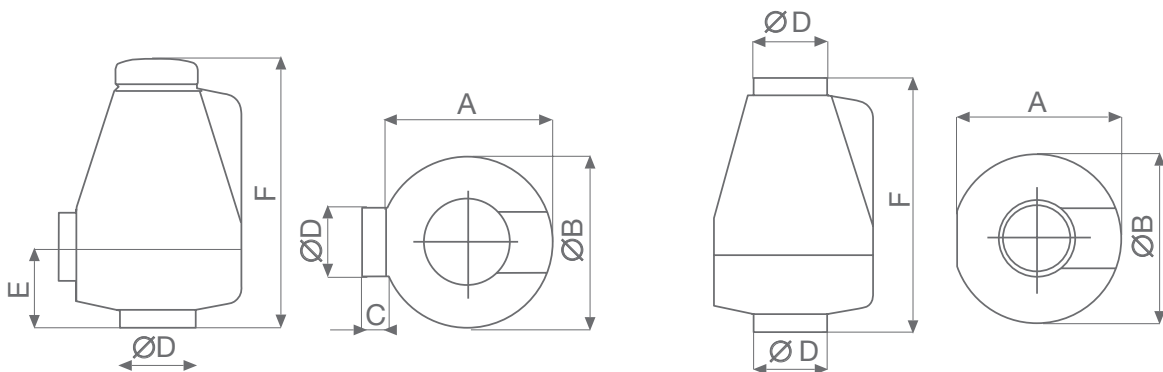

MODELS	øA	øB	C	øD	E	F
ANGOL K	168	176	25	97	93	281
AXIAL K	168	176	-	97	-	270

Dimensions (mm)



## RESIDENTIAL VENTILATION

K RANGE

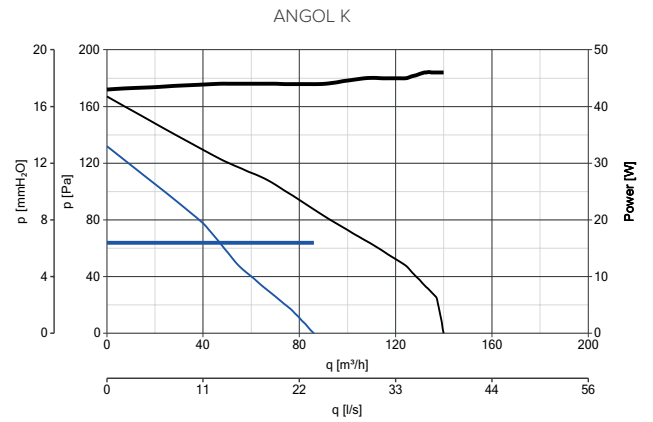
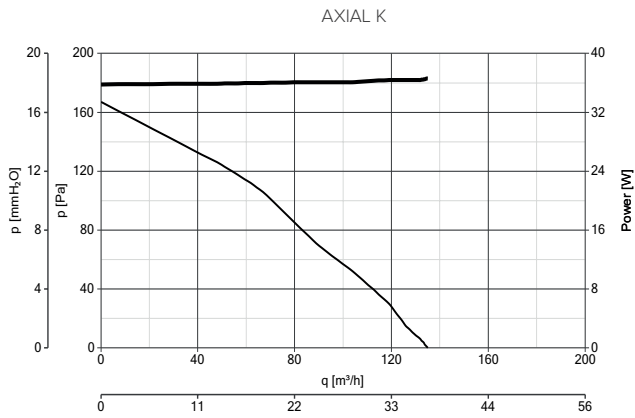

### PERFORMANCE CURVES





POWER CONSUMPTION  
 — max  
 — min

PERFORMANCE CURVES  
 — max  
 — min

### CONTROLLER

MODELS	DESCRIPTION	CODE	PRODUCT
	<b>C 1.5</b> - Electronic speed controller 1.5 A	12966	ALL PRODUCTS
	<b>SCNRB</b> - Electronic speed controller built-in	12971	ALL PRODUCTS
	<b>SCB KIT</b> - Built-in controller adaptor for C 1.5	22481	12966

### ACCESSORIES ON REQUEST

MODELS	DESCRIPTION	CODE	PRODUCT	
	<b>AIR DEFLECTOR</b>	100/4	22310	ALL PRODUCTS
	<b>CA MU</b> - Galvanized sheet-metal brackets	22674	ALL PRODUCTS	



APPLICATIONS

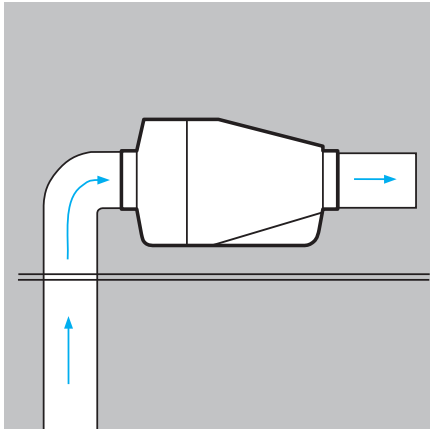
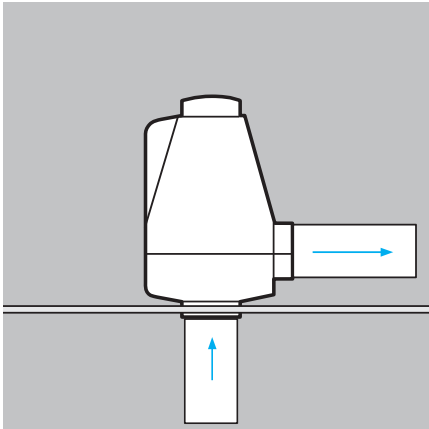
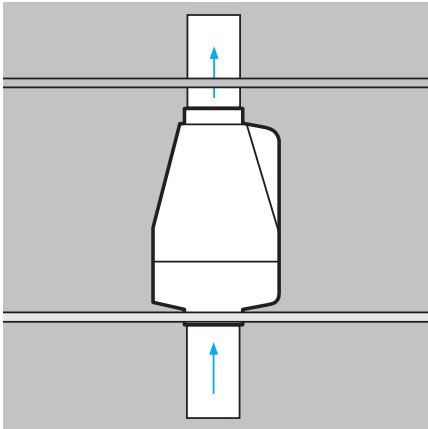

## VORTEX® RANGE

### Cooker hoods



For ventilation of kitchens, these cooker hoods blend in well with any style of kitchen décor.

- **2 models:** 60 and 90 cm sizes. All models are supplied in extractor mode but can be converted to the recycling filtering mode using the optional kit.
- Supplied with self-illuminating, ergonomic buttons which allow selection of one of the three available speeds, according to the particular need.
- Excellent lighting with 40 W light bulbs and polycarbonate diffuser, ensures no alteration to the colour of food in the cooking area.
- Powerful yet silent, the low noise level at first speed is ideal when having to spend considerable time in the kitchen.
- Rugged construction with frame made of stainless-steel, coated in anti-scratch polyester-epoxy powder, motor-holder and fan made of self-extinguishing resin. Three-speed motor with Class B insulation and thermal cut-out for overheat protection.
- Filtering system: these models are equipped with a fabric grease filter.
- Complete with main fitting for 120 mm dia. duct and secondary fitting for 100 mm dia. duct, a cover with two discharge ports, activated-carbon filters for changing to the filtering type, air backdraught shutter, installation fixings, connection cable without plug.
- Insulation class: II .



#### TECHNICAL DATA

MODELS	CODE	COLOUR	V~50HZ	W max	MAX AIRFLOW		MAX PRESSURE		Lp dB(A) 3m max	KG
					m <sup>3</sup> /h min/max	l/s min/max	mmH <sub>2</sub> O min/max	Pa min/max		
VORTEX 60-B	20021	WHITE	230-240	120 +40	120 250	33 69	12 21	118 210	37 56	8.5
VORTEX 60-I	20022	INOX	230-240	120 +40	120 250	33 69	12 21	118 210	37 56	8.5
VORTEX 90-B	20023	WHITE	230-240	120 +40	120 250	33 69	12 21	118 210	37 56	11.0
VORTEX 90-I	20024	INOXW	230-240	120 +40	120 250	33 69	12 21	118 210	37 56	11.0



## VORTEX RANGE | TECHNICAL DATA FOR REGULATION N° 1254/2014/UE

	UNIT OF MEASURE	VORTEX 60	VORTEX 90
Supplier's name or trade mark	-	Vortice	Vortice
Annual energy consumption (AEC <sub>hood</sub> )	kWh/a	86.3	86.3
Energy efficiency class.	-	E	E
Fluid dynamic efficiency	-	5.3	5.3
Fluid dynamic efficiency class.	-	F	F
Light efficiency	lux/W	2.0	2.0
Lighting efficiency class.	-	G	G
Grease filtering efficiency	%	64.1	64.1
Grease filtering efficiency class.	-	E	E
Air flow at minimum speed	m <sup>3</sup> /h	110	110
Air flow at maximum speed in normal use	m <sup>3</sup> /h	235	235
Air flow at intensive or boost setting	m <sup>3</sup> /h	-	-
Airborne acoustical A-weighted sound power emissions at minimum speed	dB(A) re 1pW	51	51
Airborne acoustical A-weighted sound power emissions at maximum speed in normal use	dB(A) re 1pW	69	69
Airborne acoustical A-weighted sound power emissions at intensive or boost setting	dB(A) re 1pW	-	-
Power consumption in off mode (P <sub>o</sub> )	W	-	-
Power consumption in standby mode (P <sub>s</sub> )	W	0.00	0.00
Time increase factor (f)	-	1.8	1.8
Energy efficiency index (EEI <sub>hood</sub> )	-	100.6	100.6
Measured air flow rate at best efficiency point (QBEP)	m <sup>3</sup> /h	122.2	122.2
Measured air pressure at best efficiency point (PBEP)	Pa	155	155
Maximum air flow (Q <sub>max</sub> )	m <sup>3</sup> /h	235.0	235.0
Measured electric power input at best efficiency point (WBEP)	m <sup>3</sup> /h	100.2	100.2
Nominal power of the lighting system (W <sub>L</sub> )	W	28.0	28.0
Average illumination of the lighting system on the cooking surface (E <sub>middle</sub> )	lux	57	57

## DIMENSIONS

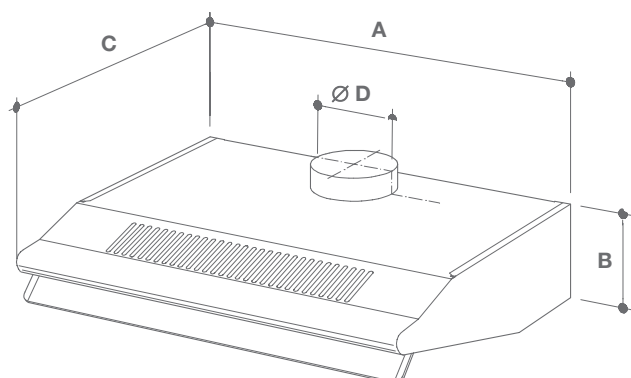

MODELS	A	B	C	ØD
VORTEX 60	600	140	495	123
VORTEX 90	900	140	495	123

Dimensions (mm)



## RESIDENTIAL VENTILATION

VORTEX® RANGE

### ACCESSORIES ON REQUEST

MODELS	DESCRIPTION	CODE	PRODUCT
	<b>T - EXTRACTION KIT</b>	22101	ALL PRODUCT
	<b>VX - CB</b> - Telescopic chimney white	22116	20021 - 20023
	<b>VX - CI</b> - Telescopic chimney stainless steel	22117	20022 - 20024
	<b>VX - FC 60</b> - Activated carbon filter	22314	20021 - 20023
	<b>VX - FC 90</b> - Activated carbon filter	22322	20022 - 20024
	<b>VX - FA 90</b> - Paper filter Vortex 90	22307	20022 - 20024
	<b>G - 23/9"</b> - Air replacement grilles	22114	ALL PRODUCT







APPLICATIONS

---





## ARIETT RANGE

Centrifugal duct fans **LONG LIFE 30.000h**

For the ventilation of areas with intermittent use (small bathrooms, private or public toilets).



Design: F. Trabucco - M. Vecchi



- **2 models.**
- Motor with shielded poles and ball bearings (guaranteed for 30,000 fault-free hours of operation) and thermal overload protection.
- Double motor-fan housing, antivibration supports and backdraught shutter for silent operation.
- The timer is adjustable from 3 to 20 min.
- Pir model, checks for human motion in the room: the extractor fan is activated automatically when human movement is detected in its range.
- T-HCS model, adjustable RH threshold at 60%, 70%, 80%, 90% by mean of a slide switch during installation. The product automatically switches on when the indoor relative humidity level exceeds the pre-set value.
- 100 mm dia. outlet spigot.
- Data and performances IMQ Performance certified.
- Protection rating: IPX4.
- Insulation class: II .

### TECHNICAL DATA

MODELS	CODE		V~50HZ	W max	A max	RPM max	MAX AIRFLOW		MAX PRESSURE		Lp dB(A)* 3m max	MAX °C	KG
	BASIC	TIMER					m³/h	l/s	mmH <sub>2</sub> O	Pa			
ARIETT LL	11313	-	230	18	0.14	2315	70	19.4	12	118	40	40	1.50
ARIETT LL T	-	11966	230	18	0.14	2315	70	19.4	12	118	40	40	1.50

\* Conforms with ISO 3744 for noise and pressure levels.



ARIETT RANGE | TECHNICAL DATA FOR REGULATION N° 1254/2014/UE

	UNIT OF MEASURE	ARIETT
Supplier's name or trade mark	-	Vortice
Specific Energy Consumption class SEC in average climate zone	-	NA
Specific Energy Consumption class SEC average	-	-5.5
Specific Energy Consumption class SEC cold	kWh/m <sup>2</sup> year	-18.9
Specific Energy Consumption class SEC warm	-	2.1
Declared typology	-	RVU-U*
Type of drive	-	NA
Type of heat recovery system HRS	-	none
Thermal efficiency of heat recovery at reference air flow	%	NA
Maximum flow rate	m <sup>3</sup> /h	71
Electric power input of the fan drive, including any motor control equipment, at maximum flow rate	W	13.7
Sound power level LWA	LWA [DB(A)]	61
Reference flow rate	m <sup>3</sup> /s	0.0138
Reference pressure difference	Pa	77
SPI	W/(m <sup>3</sup> /h)	0.24547
Control factor CTRL	-	1
Control typology	-	manual
Maximum internal leakage rates	%	NA
Maximum external leakage rates	%	NA
Mixing rate	-	NA
Position and description of visual filter warning	-	NA
Airflow sensitivity to pressure variations at + 20 Pa and - 20 Pa	-	NA
Indoor/outdoor air tightness	m <sup>3</sup> /h	NA
Annual electricity consumption (AEC)	kWh electricity/year	338
AHS average Annual heating saved	-	1397
AHS cold Annual heating saved	kWh primary energy/year	2732
AHS warm Annual heating saved	-	632

\* RVU-U: Unit Ventilation Residential - Unidirectional  
 \*\* NRVU-U: Unit Ventilation Non Residential - Unidirectional  
 \*\*\* MSD: Multi-Speed Drive  
 NA: Not applicable

DIMENSIONS

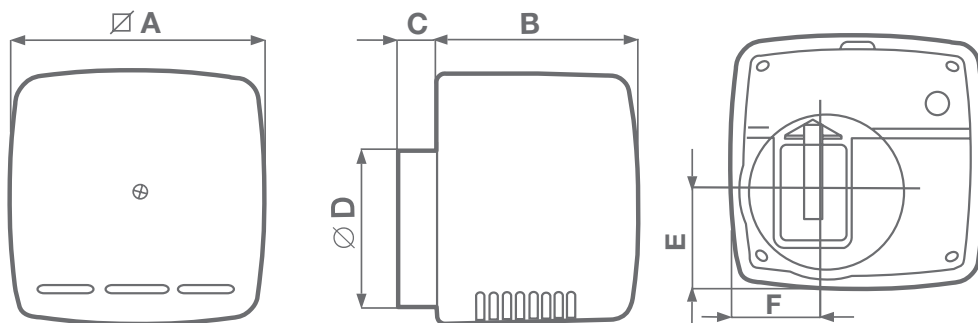

MODELS	∅ A	B	C	∅ D	E	F
ARIETT LL	156	123	25	97	60	60

Dimensions (mm)





## RESIDENTIAL VENTILATION

ARIETT RANGE

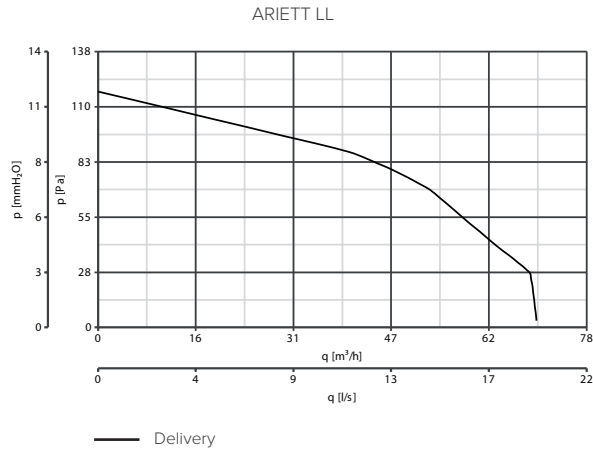
### PERFORMANCE CURVES



### CONTROLLER

MODELS	DESCRIPTION	CODE	PRODUCT
	<b>C 1.5</b> - Electronic speed controller 1.5 A	12966	ALL PRODUCTS
	<b>SCNRB</b> - Electronic speed controller built-in	12971	ALL PRODUCTS
	<b>SCB KIT</b> - Built-in controller adaptor for C 1.5	22481	12966

### ACCESSORIES ON REQUEST

MODELS	DESCRIPTION	CODE	PRODUCT
	<b>AIR DEFLECTOR</b>	100/4 22310	ALL PRODUCTS



APPLICATIONS

---





## ARIETT HABITAT RANGE

Centrifugal duct fans **LONG LIFE 30.000h**



For continuous ventilation, with boost facility. Ideal for use in public sector housing in bathrooms, showers, utilities and toilets.

- **2 models:** Habitat 15/30 can be used to provide trickle ventilation for rooms housing open-flued combustion appliances.
- Two speeds.
- Motor with shielded poles and ball bearings (guaranteed for 30,000 fault-free hours of operation) and thermal overload protection.
- Low power consumption.
- Fully comply with F1 Building Regulations, plus 1.9D alternative approaches.
- Antivibration support gasket, used for mounting on tiled or uneven walls.
- Backdraught-shutter to avoid back flow when unit is turned off.
- Available only for model 15/30.
- 100 mm dia. outlet spigot.
- Complete with fixings.
- Protection rating: IPX4.
- Insulation class: II

Design: F. Trabucco & Associates



### TECHNICAL DATA

MODEL	CODE	V~50HZ	W min/max	A min/max	RPM min/max	MAX AIRFLOW		MAX PRESSURE		Lp dB(A) 3m max	MAX °C	KG
						m <sup>3</sup> /h min/max	l/s min/max	mmH <sub>2</sub> O min/max	Pa min/max			
ARIETT HABITAT LL 15/30	12000	230-240	5 8	0.02 0.04	1260 1870	20 43	5.6 11.9	8 10	78 98	30 41.5	40	1.20
ARIETT HABITAT LL 20/75	12001	230-240	6 25	0.03 0.17	890 2470	27 85	7.5 23.6	8 12	78 118	30.5 51	40	1.40

\* Conforms with ISO 3744 for noise and pressure levels.



ARIETT HABITAT RANGE | TECHNICAL DATA FOR REGULATION N° 1254/2014/UE

	UNIT OF MEASURE	ARIETT HABITATT LL 15/30	ARIETT HABITATT LL 20/75
Supplier's name or trade mark	-	Vortice	Vortice
Specific Energy Consumption class SEC in average climate zone	-	NA	NA
Specific Energy Consumption class SEC average	-	-4,2	0,2
Specific Energy Consumption class SEC cold	kWh/m <sup>2</sup> year	-17,6	-13,2
Specific Energy Consumption class SEC warm	-	3,5	7,8
Declared typology	-	RVU-U*	RVU-U*
Type of drive	-	NA	NA
Type of heat recovery system HRS	-	none	none
Thermal efficiency of heat recovery at reference air flow	%	NA	NA
Maximum flow rate	m <sup>3</sup> /h	39	74
Electric power input of the fan drive, including any motor control equipment, at maximum flow rate	W	8,2	22,8
Sound power level LWA	LWA [DB(A)]	53	62
Reference flow rate	m <sup>3</sup> /s	0,0076	0,41120
Reference pressure difference	Pa	60	73
SPI	W/(m <sup>3</sup> /h)	0,28353	0,41120
Control factor CTRL	-	1	1
Control typology	-	manual	manual
Maximum internal leakage rates	%	NA	NA
Maximum external leakage rates	%	NA	NA
Mixing rate	-	NA	NA
Position and description of visual filter warning	-	NA	NA
Airflow sensitivity to pressure variations at + 20 Pa and - 20 Pa	-	NA	NA
Indoor/outdoor air tightness	m <sup>3</sup> /h	NA	NA
Annual electricity consumption (AEC)	kWh electricity/year	NA	NA
AHS average Annual heating saved	-	NA	NA
AHS cold Annual heating saved	kWh primary energy/year	NA	NA
AHS warm Annual heating saved	-	391	567

\* RVU-U: Unit Ventilation Residential - Unidirectional  
 \*\* NRVU-U: Unit Ventilation Non Residential - Unidirectional  
 \*\*\* MSD: Multi-Speed Drive  
 NA: Not applicable

DIMENSIONS

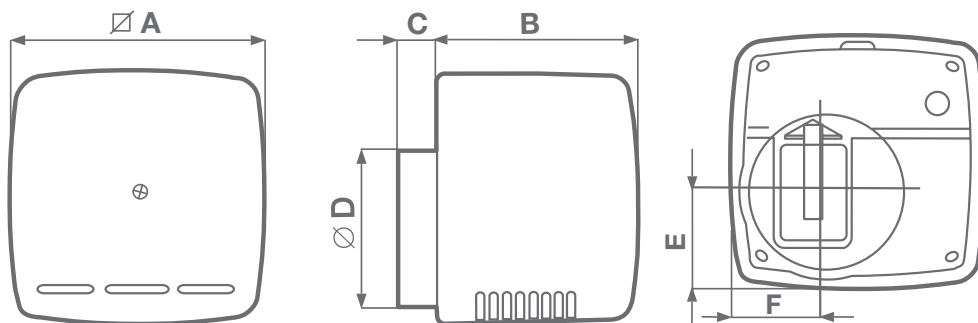

MODELS	∅ A	B	C	∅ D	E	F
ARIETT LL	156	123	25	97	60	60

Dimensions (mm)



## RESIDENTIAL VENTILATION

ARIETT HABITAT RANGE

### PERFORMANCE CURVES

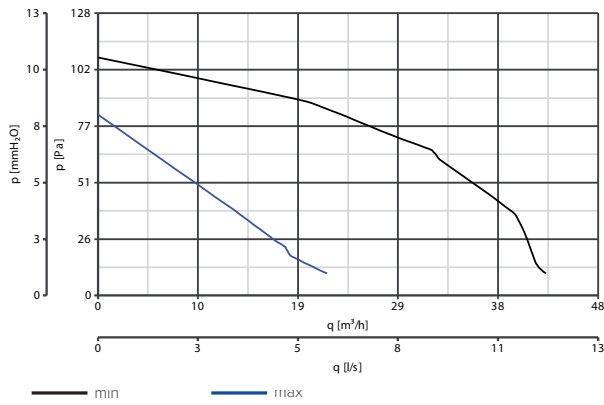

ARIETT HABITAT LL 15/30

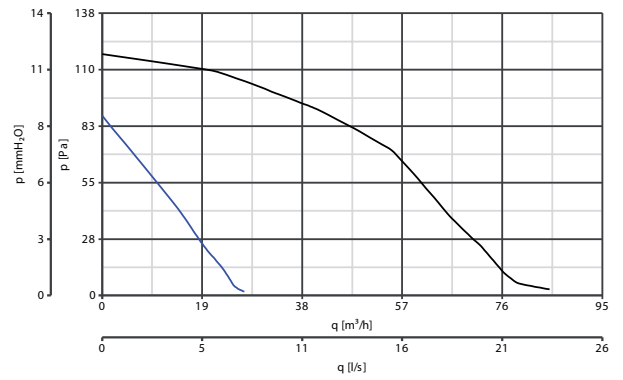

ARIETT HABITAT LL 20/75



### CONTROLLER

MODELS	DESCRIPTION	CODE	PRODUCT
	<b>C 1.5</b> - Electronic speed controller 1.5 A	12966	ALL PRODUCTS
	<b>SCNRB</b> - Electronic speed controller built-in	12971	ALL PRODUCTS
	<b>SCB KIT</b> - Built-in controller adaptor for C 1.5	22481	12966

### ACCESSORIES ON REQUEST

MODELS	DESCRIPTION	CODE	PRODUCT
	<b>AIR DEFLECTOR</b>	100/4 22310	ALL PRODUCTS
	<b>HORIZONTAL OUTLET - LOW PROFILE</b>	22482	ALL PRODUCTS
	<b>FALSE-CEILING/WALL INSTALLATION KIT</b>	22823	ALL PRODUCTS





APPLICATIONS

---



## ARIETT I RANGE

Centrifugal duct fans for flush mounting **LONG LIFE 30.000h**

Suitable for use in bathrooms, shower rooms and toilets.

- **2 models:** basic and timer version.
- Two speeds.
- Motor with shielded poles and ball bearings (guaranteed for 30,000 fault-free hours of operation) and thermal overload protection.
- Double motor-fan housing, antivibration supports and backdraught shutter for silent operation.
- Unobtrusive front grille.
- Support springs for the front grille, suitable for 65 mm max false ceilings.
- Metallic filter which can be removed and washed (dishwasher safe).
- Vertical or horizontal extract points.
- All fans have the optional side or rear exit low profile connector, or high profile connector.
- Backdraught-shutter to avoid back-flow when unit is turned off.
- Timer models, the timer is adjustable from 3 to 20 min.
- The fans meet all necessary requirement of F1 building regulations.
- Data and performances IMQ Performance certified.
- Protection rating: IPX4.
- Insulation class: II

Design: F. Trabucco & Associates



### TECHNICAL DATA

MODELS	CODE		V~50HZ	W max	A max	RPM max	MAX AIRFLOW		MAX PRESSURE		Lp dB(A) <sup>1</sup> 3m max	MAX °C	KG
	BASIC	TIMER					m <sup>3</sup> /h	l/s	mmH <sub>2</sub> O	Pa			
ARIETT LL I	12010	-	230	19	0.13	2360 <sup>1</sup> 2460 <sup>2</sup>	80 <sup>1</sup> 70 <sup>2</sup>	22.2 <sup>1</sup> 19.4 <sup>2</sup>	11	108	40	40	1.90
ARIETT LL I T	-	12011	230	19	0.13	2360 <sup>1</sup> 2460 <sup>2</sup>	80 <sup>1</sup> 70 <sup>2</sup>	22.2 <sup>1</sup> 19.4 <sup>2</sup>	11	108	40	40	1.90

<sup>1</sup>Rear air outlet. <sup>2</sup>Side air outlet with high profile.



ARIETT I RANGE | TECHNICAL DATA FOR REGULATION N° 1254/2014/UE

	UNIT OF MEASURE	ARIETT LL I - ARIETT LL I T
Supplier's name or trade mark	-	Vortice
Specific Energy Consumption class SEC in average climate zone	-	NA
Specific Energy Consumption class SEC average	-	-5.3
Specific Energy Consumption class SEC cold	kWh/m <sup>2</sup> year	-18.6
Specific Energy Consumption class SEC warm	-	-2,4
Declared typology	-	RVU-U*
Type of drive	-	NA
Type of heat recovery system HRS	-	none
Thermal efficiency of heat recovery at reference air flow	%	NA
Maximum flow rate	m <sup>3</sup> /h	72
Electric power input of the fan drive, including any motor control equipment, at maximum flow rate	W	13.75
Sound power level LWA	LWA [DB(A)]	64
Reference flow rate	m <sup>3</sup> /s	0.0140
Reference pressure difference	Pa	72
SPI	W/(m <sup>3</sup> /h)	0.25198
Control factor CTRL	-	1
Control typology	-	manual
Maximum internal leakage rates	%	NA
Maximum external leakage rates	%	NA
Mixing rate	-	NA
Position and description of visual filter warning	-	NA
Airflow sensitivity to pressure variations at + 20 Pa and - 20 Pa	-	NA
Indoor/outdoor air tightness	m <sup>3</sup> /h	NA
Annual electricity consumption (AEC)	kWh electricity/year	347
AHS average Annual heating saved	-	1397
AHS cold Annual heating saved	kWh primary energy/year	2732
AHS warm Annual heating saved	-	632

\* RVU-U: Unit Ventilation Residential - Unidirectional  
 \*\* NRVU-U: Unit Ventilation Non Residential - Unidirectional  
 \*\*\* MSD: Multi-Speed Drive  
 NA: Not applicable

DIMENSIONS

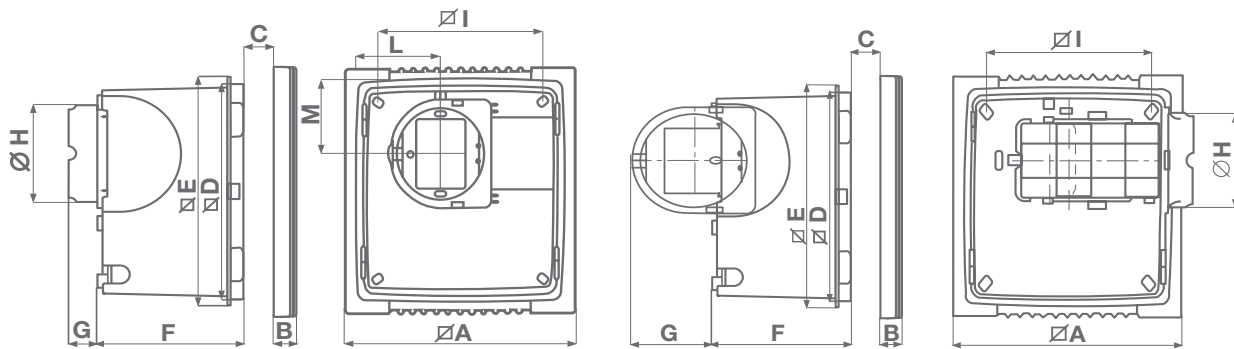

MODELS	∅A	B	C	∅D	∅E	F	G	H	∅I	L	M
ARIETT LL I	252	23	65	214,5	228	135,5	31,5 76,7	96,5	180	92	76

Dimensions (mm)



## RESIDENTIAL VENTILATION

### ARIETT I RANGE

#### MAIN COMPONENTS

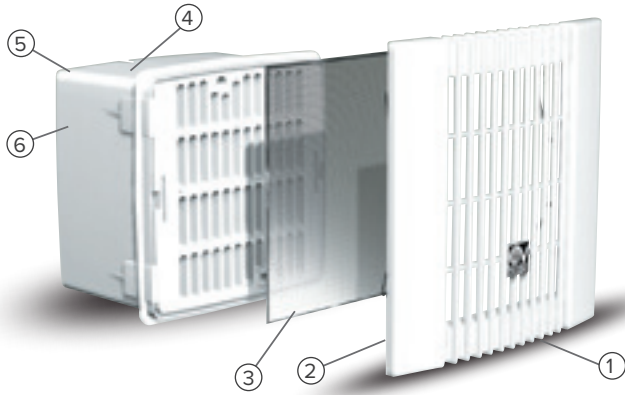

- ① Unobtrusive front grille.
- ② Support springs for the front grille, suitable for 65 mm max false ceilings.
- ③ Metallic filter which can be removed and washed (dishwasher safe) (available on LL version models only).
- ④ Made of rigid synthetic resin to guarantee high durability.
- ⑤ 100 mm dia. Outlet spigot which can be positioned to the rear or side (using optional accessories).
- ⑥ Backdraught-shutter to avoid back-flow when unit is turned off.



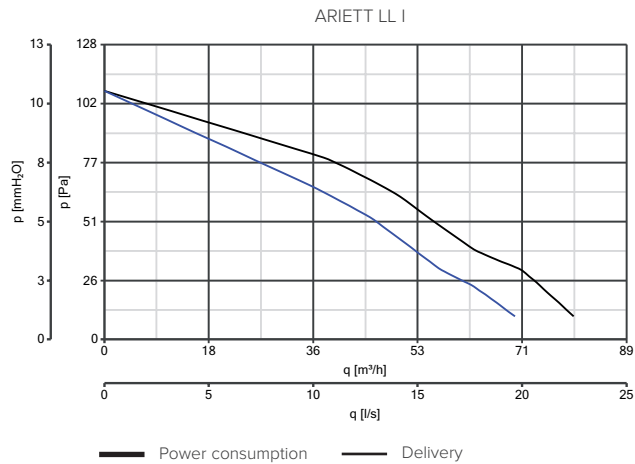

#### PERFORMANCE CURVES



#### CONTROLLER

MODELS	DESCRIPTION	CODE	PRODUCT
	<b>C 1.5</b> - Electronic speed controller 1.5 A	12966	12010
	<b>SCNRB</b> - Electronic speed controller built-in	12971	ALL PRODUCTS
	<b>SCB KIT</b> - Built-in controller adaptor for C 1.5	22481	12966

#### ACCESSORIES ON REQUEST

MODELS	DESCRIPTION	CODE	PRODUCT
	<b>AIR DEFLECTOR</b>	100/4 22310	ALL PRODUCTS
	<b>HORIZONTAL OUTLET - LOW PROFILE</b>	22842	ALL PRODUCTS
	<b>HORIZONTAL OUTLET - HIGH PROFILE</b>	22841	ALL PRODUCTS
	<b>FALSE-CEILING/WALL INSTALLATION KIT</b>	22823	ALL PRODUCTS



APPLICATIONS

---





## VORT PRESS RANGE

Centrifugal duct fans **LONG LIFE 30.000h**



Design: F. Trabucco - M. Vecchi



For the ventilation of medium-sized rooms in commercial applications plus bathrooms, showers, toilets, utilities in domestic situations.

- **2 models**, with or without timer.
- Double motor-fan housing, antivibration supports and backdraught shutter for silent operation.
- Three speeds.
- Motor with ball bearings (guaranteed 30,000 hours of continuous operation) with thermal cut-out.
- Metallic filter which can be removed and washed (dishwasher safe).
- 100 mm dia. outlet spigot.
- Backdraught-shutter to avoid back flow when unit is turned off.
- “Intelligent” timer turns the unit on for approximately 40 sec. after the activation. When switched off, the unit continues to operate at the minimum speed for between 30 sec. and 30 min. (depending on the setting).
- Data and performances IMQ Performance certified.
- Protection rating: IPX4.
- Insulation class: II .

### Spare Parts

- Metallic anti-dust filter.





## TECHNICAL DATA

MODELS	CODE		V~50HZ	W max	A max	RPM max	MAX AIRFLOW		MAX PRESSURE		Lp dB(A)* 3m max	MAX °C	KG
	BASIC	TIMER					m³/h	l/s	mmH <sub>2</sub> O	Pa			
VORT PRESS 110 LL	11967	11968	220-240	12 24	0,07 0,22	925 1760	55 110	15,3 30,6	10 16	98 157	30 41	40	1,95
VORT PRESS 220 LL	11977	11978	220-240	14 64	0,11 0,42	1200 2380	125 260	35 72	11 35	108 343	43 55	40	2,30

\* Conforms with ISO 3744 for noise and pressure levels.

## VORT PRESS RANGE | TECHNICAL DATA FOR REGULATION N° 1254/2014/UE

	UNIT OF MEASURE	VORT PRESS 110 LL - VORTICE PRESS 110 LL T
Supplier's name or trade mark	-	Vortice
Specific Energy Consumption class SEC in average climate zone	-	NA
Specific Energy Consumption class SEC average	-	-2,7
Specific Energy Consumption class SEC cold	kWh/m <sup>2</sup> year	-16
Specific Energy Consumption class SEC warm	-	5,0
Declared typology	-	RVU-U*
Type of drive	-	NA
Type of heat recovery system HRS	-	none
Thermal efficiency of heat recovery at reference air flow	%	NA
Maximum flow rate	m <sup>3</sup> /h	109
Electric power input of the fan drive, including any motor control equipment, at maximum flow rate	W	29,0
Sound power level LWA	LWA [DB(A)]	62
Reference flow rate	m <sup>3</sup> /s	0.0212
Reference pressure difference	Pa	95
SPI	W/(m <sup>3</sup> /h)	0.32765
Control factor CTRL	-	1
Control typology	-	manual
Maximum internal leakage rates	%	NA
Maximum external leakage rates	%	NA
Mixing rate	-	NA
Position and description of visual filter warning	-	NA
Airflow sensitivity to pressure variations at + 20 Pa and – 20 Pa	-	NA
Indoor/outdoor air tightness	m <sup>3</sup> /h	NA
Annual electricity consumption (AEC)	kWh electricity/year	451
AHS average Annual heating saved	-	1397
AHS cold Annual heating saved	kWh primary energy/year	2732
AHS warm Annual heating saved	-	632

\* RVU-U: Unit Ventilation Residential - Unidirectional

\*\* NRVU-U: Unit Ventilation Non Residential - Unidirectional

\*\*\* MSD: Multi-Speed Drive

NA: Not applicable





## RESIDENTIAL VENTILATION

### VORT PRESS RANGE

#### VORT PRESS RANGE | TECHNICAL DATA FOR REGULATION N° 1254/2014/UE

	UNIT OF MEASURE	VORT PRESS 220 LL - VORTICE PRESS 220 LL T
Supplier's name or trade mark	-	Vortice
Declared typology	-	NRVU-U*
Type of drive	-	VSD***
Type of heat recovery system HRS	-	None
Thermal efficiency of heat recovery	-	NA
Nominal NRVU flow rate	m <sup>3</sup> /s	0,0586
Effective electric power input	kW	0,06
SFPint	W/(m <sup>3</sup> /h)	606,75
Face velocity at design flow rate	m/s	7,93134
Nominal external pressure ( $\Delta p_{s,int}$ )	Pa	110
Internal pressure drop of ventilation components ( $\Delta p_{s,int}$ )	Pa	160
Internal pressure drop of non-ventilation components ( $\Delta p_{s,int}$ )	Pa	0
Static efficiency of fans used in accordance with Regulation (EU) N. 3272011	%	26,4
Declared maximum internal leakage rate of the casing of ventilation units	%	NA
Declared maximum external leakage rate of the casing of ventilation units	%	NA
Energy performance energy or classification of the filters	-	NA
Description of visual filter warning	%	NA
Casing sound power level (LWA)	dB(A)	76

\* RVU-U: Unit Ventilation Residential - Unidirectional

\*\* NRVU-U: Unit Ventilation Non Residential - Unidirectional

\*\*\* VSD: Variable-Speed Drive

NA: Not applicable

#### DIMENSIONS

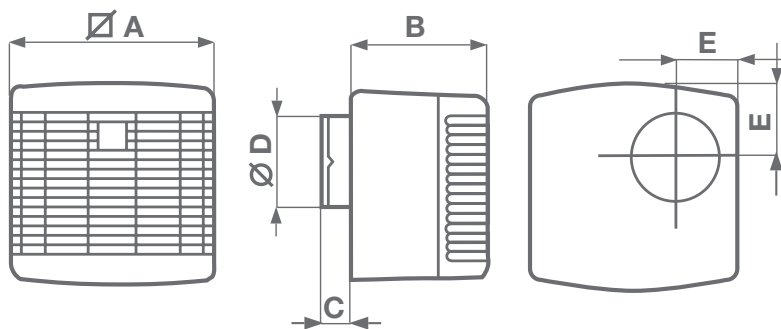

MODELS	∅ A	B	C	∅ D	E
VORT PRESS 110 LL	202	147	30	97	60

Dimensions (mm)

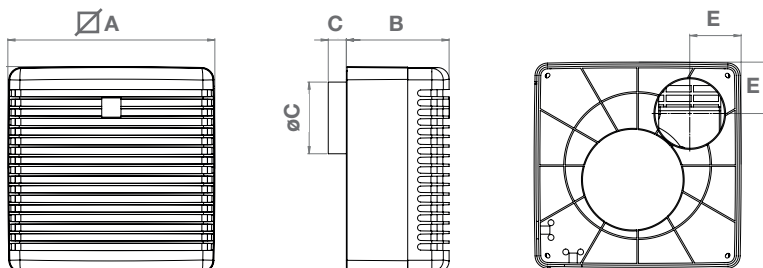

MODELS	∅ A	B	C	∅ D	E
VORT PRESS 220 LL	280	140	28	97	70

Dimensions (mm)



MAIN COMPONENTS

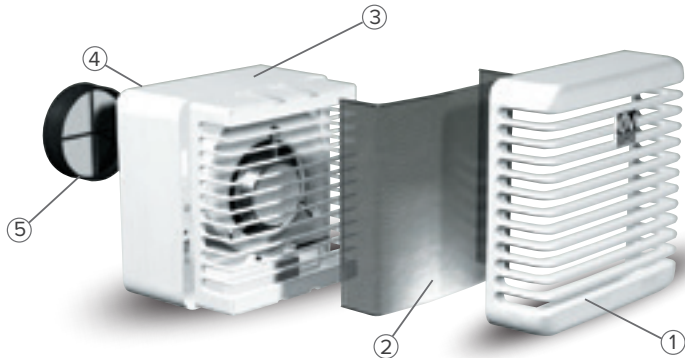

- ① Front grille.
- ② Metallic filter which can be removed and washed (dishwasher safe).
- ③ Made of rigid synthetic resin to guarantee high durability.
- ④ 100 mm dia. outlet spigot.
- ⑤ Silicon backdraught shutter to avoid back-flow when the unit is turned off.

PERFORMANCE CURVES

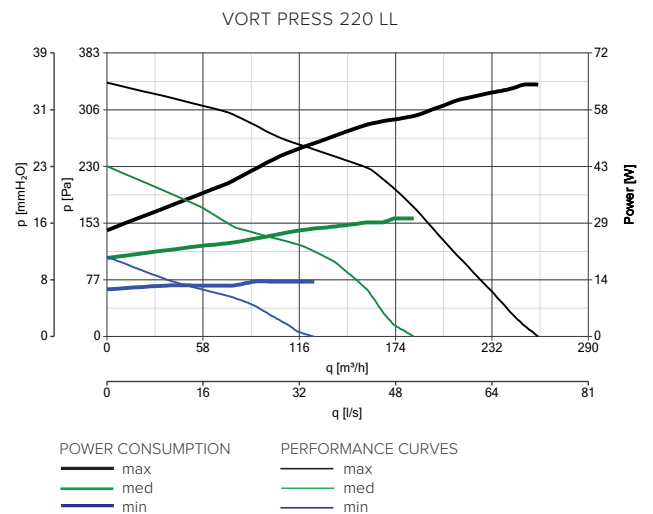
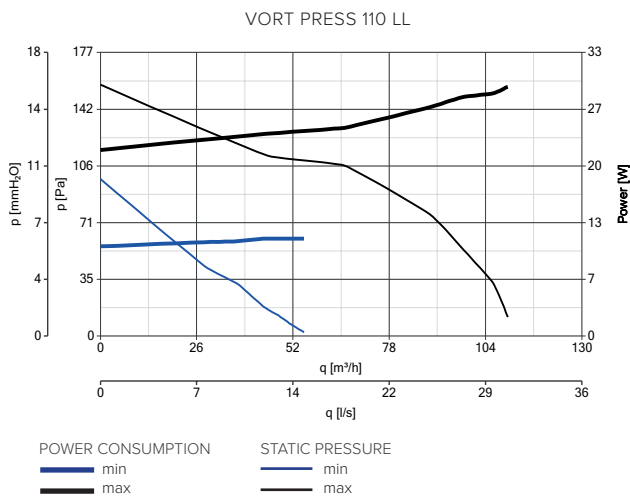

CONTROLLER

MODELS	DESCRIPTION	CODE	PRODUCT
	<b>C 1.5</b> - Electronic speed controller 1.5 A	12966	ALL PRODUCTS
	<b>SCNRB</b> - Electronic speed controller built-in	12971	ALL PRODUCTS
	<b>SCB KIT</b> - Built-in controller adaptor for C 1.5	22481	12966
	<b>POT-IT</b> - Potentiometer equipped with On/Off switch, for installation in 503 Standard Box.	12826	11977 - 11978
	<b>POT</b> - Potentiometer for installation in Standard DIN box.	12828	11977 - 11978

ACCESSORIES ON REQUEST

MODELS	DESCRIPTION	CODE	PRODUCT	
	<b>AIR DEFLECTOR</b>	100/4	22310	ALL PRODUCTS
	<b>HORIZONTAL OUTLET - LOW PROFILE</b>		22842	ALL PRODUCTS
	<b>FALSE-CEILING/WALL INSTALLATION KIT</b>		22823	ALL PRODUCTS



## VORT PRESS HABITAT RANGE

Centrifugal duct fans **LONG LIFE 30.000h**

For continuous ventilation with boost facility. Ideal for use in public sector houses in bathrooms, showers, toilets, utility rooms and kitchens.

- **2 models:** basic and timer version.
- Motor with ball bearings (guaranteed 30,000 hours of continuous operation) with thermal cut-out.
- Two speeds.
- Double motor-fan housing, antivibration supports and backdraught shutter for silent operation.
- Metallic filter which can be removed and washed (dishwasher safe).
- 100 mm dia. outlet spigot.
- Fully comply with F1 Building Regulations, plus 1.9D alternative approaches.
- Data and performances IMQ Performance certified.
- Protection rating: IPX4.
- Insulation class: II

Design: F. Trabucco &amp; Associati



### Spare Parts

- Metallic anti-dust filter.

### TECHNICAL DATA

MODELS	CODE	V~50HZ	W min/max	A min/max	RPM min/max	MAX AIRFLOW		MAX PRESSURE		Lp dB(A) 3m max	MAX °C	KG
						m <sup>3</sup> /h min/max	l/s min/max	mmH <sub>2</sub> O min/max	Pa min/max			
VORT PRESS HABITAT LL 30/90	12002	230	8 22	0.06 0.18	820 1450	51 101	14.2 28.1	4 14	39 137	28.5 44.5	40	2.1
VORT PRESS HABITAT LL 45/135	12004	230	4 29	0.04 0.12	430 1170	52 149	14.4 41.4	5 23	49 225	26.5 48	40	2.7

\* Conforms with ISO 3744 for noise and pressure levels.



## VORT PRESS HABITAT RANGE | TECHNICAL DATA FOR REGULATION N° 1254/2014/UE

	UNIT OF MEASURE	ARIETT HABITATT LL 15/30	ARIETT HABITATT LL 20/75
Supplier's name or trade mark	-	Vortice	Vortice
Specific Energy Consumption class SEC in average climate zone	-	NA	NA
Specific Energy Consumption class SEC average	-	-2,6	-4,0
Specific Energy Consumption class SEC cold	kWh/m <sup>2</sup> year	-15,9	-17,3
Specific Energy Consumption class SEC warm	-	5,1	3,7
Declared typology	-	RVU-U*	RVU-U*
Type of drive	-	NA	NA
Type of heat recovery system HRS	-	none	none
Thermal efficiency of heat recovery at reference air flow	%	NA*	NA*
Maximum flow rate	m <sup>3</sup> /h	90	143
Electric power input of the fan drive, including any motor control equipment, at maximum flow rate	W	21,0	29,58
Sound power level LWA	LWA [DB(A)]	56	59
Reference flow rate	m <sup>3</sup> /s	0,0175	0,0278
Reference pressure difference	Pa	53	95
SPI	W/(m <sup>3</sup> /h)	0,33016	0,28971
Control factor CTRL	-	1	1
Control typology	-	manual	manual
Maximum internal leakage rates	%	NA	NA
Maximum external leakage rates	%	NA	NA
Mixing rate	-	NA	NA
Position and description of visual filter warning	-	NA	NA
Airflow sensitivity to pressure variations at + 20 Pa and - 20 Pa	-	NA	NA
Indoor/outdoor air tightness	m <sup>3</sup> /h	NA	NA
Annual electricity consumption (AEC)	kWh electricity/year	455	339
AHS average Annual heating saved	-	1397	1397
AHS cold Annual heating saved	kWh primary energy/year	2732	2732
AHS warm Annual heating saved	-	632	632

\* RVU-U: Unit Ventilation Residential - Unidirectional

\*\* NRVU-U: Unit Ventilation Non Residential - Unidirectional

\*\*\* MSD: Multi-Speed Drive

NA: Not applicable

## DIMENSIONS

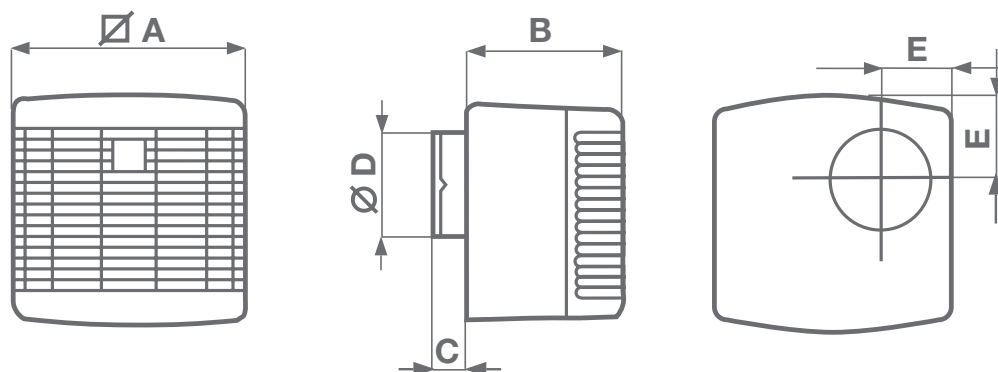

MODEL	∅ A	B	C	∅ D	E
VORT PRESS HABITAT LL 30/90	202	147	30	97	73
VORT PRESS HABITAT LL 45/135	275	140	28	97	73

Dimensions (mm)



## RESIDENTIAL VENTILATION

### VORT PRESS HABITAT RANGE

#### MAIN COMPONENTS

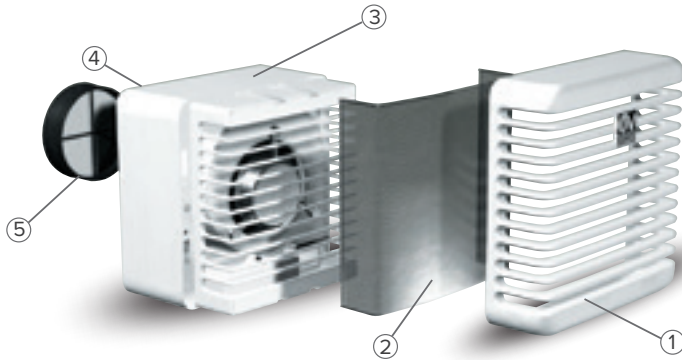

- ① Front grille.
- ② Metallic filter which can be removed and washed (dishwasher safe).
- ③ Made of rigid synthetic resin to guarantee high durability.
- ④ 100 mm dia. outlet spigot.
- ⑤ Silicon backdraught shutter to avoid back-flow when the unit is turned off.

#### PERFORMANCE CURVES

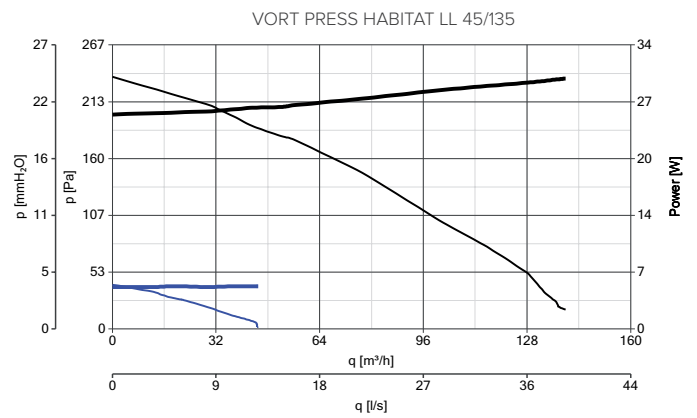
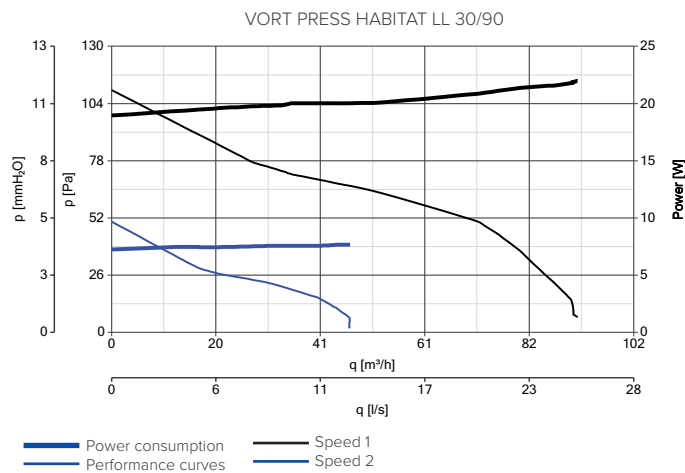

#### CONTROLLER

MODELS	DESCRIPTION	CODE	PRODUCT
	<b>C 1.5</b> - Electronic speed controller 1.5 A	12966	ALL PRODUCTS
	<b>SCNRB</b> - Electronic speed controller built-in	12971	ALL PRODUCTS
	<b>SCB KIT</b> - Built-in controller adaptor for C 1.5	22481	12966

#### ACCESSORIES ON REQUEST

MODELS	DESCRIPTION	CODE	PRODUCT
	<b>AIR DEFLECTOR</b>	100/4 22310	ALL PRODUCTS
	<b>HORIZONTAL OUTLET - LOW PROFILE</b>	22842	ALL PRODUCTS
	<b>FALSE-CEILING/WALL INSTALLATION KIT</b>	22823	ALL PRODUCTS



APPLICATIONS





## VORT PRESS I RANGE

Centrifugal duct fans for flush mounting **LONG LIFE 30.000h**

For the ventilation of medium-sized or large rooms in commercial applications plus bathrooms, showers, toilets, utilities and kitchens in domestic situations.

- **6 models**, with or without timer.
- Double motor-fan housing, antivibration supports and backdraught shutter for silent operation.
- Three speeds.
- Motor with ball bearings (guaranteed 30,000 hours of continuous operation) with thermal cut-out.
- Unobtrusive front grille.
- Support springs for the front grille, suitable for 65 mm max false ceilings.
- Metallic filter which can be removed and washed (dishwasher safe).
- “Intelligent” timer turns the unit on approximately 40 sec. after the activation. When switched off, the unit continues to operate at the minimum speed for between 30 sec. and 30 min. (depending on the setting).
- 100 mm dia. outlet spigot, all fans have the optional side or rear exit low profile connector, or high profile connector.
- Timer models, the timer is adjustable from 3 to 20 min.
- Data and performances IMQ Performance certified.
- Protection rating: IPX4.
- Insulation class: II

### Spare Parts

- Metallic anti-dust filter.

Design: F. Trabucco & Associates ( Vort Press I 110)  
F. Trabucco - M. Vecchi (Vort Press I 140 /240)



### TECHNICAL DATA

MODELS	CODE		V~50HZ	W max	A max	RPM max	MAX AIRFLOW		MAX PRESSURE		Lp dB(A) <sup>1</sup> 3m max	MAX °C	KG
	BASE	TIMER					m <sup>3</sup> /h	l/s	mmH <sub>2</sub> O	Pa			
VORT PRESS 110 LL I	11995	11996	220 240	12 24	0,07 0,18	970 <sup>1</sup>	60 <sup>1</sup>	16,7 <sup>1</sup>	8,9 <sup>1</sup>	87 <sup>1</sup>	<30 41	40	2,1
						1720 <sup>1</sup>	120 <sup>1</sup>	33,3 <sup>1</sup>	14,5 <sup>1</sup>	142 <sup>1</sup>			
						1090 <sup>2</sup>	50 <sup>2</sup>	13,9 <sup>2</sup>	8,3 <sup>2</sup>	181 <sup>2</sup>			
						1980 <sup>2</sup>	100 <sup>2</sup>	27,8 <sup>2</sup>	13,5 <sup>2</sup>	132 <sup>2</sup>			
VORT PRESS 140 LL I	11971	11972	220 240	16 27	0,05 0,10	594 <sup>1</sup>	55 <sup>1</sup>	15,3 <sup>1</sup>	8 <sup>1</sup>	78 <sup>1</sup>	<30 38	40	2,9
						1130 <sup>1</sup>	118 <sup>1</sup>	32,8 <sup>1</sup>	22 <sup>1</sup>	216 <sup>1</sup>			
						450 <sup>2</sup>	67 <sup>2</sup>	18,6 <sup>2</sup>	8 <sup>2</sup>	78 <sup>2</sup>			
						829 <sup>2</sup>	140 <sup>2</sup>	38,9 <sup>2</sup>	22 <sup>2</sup>	216 <sup>2</sup>			
VORT PRESS 240 LL I	11973	11974	220 240	12 45	0,01 0,03	1150 <sup>1</sup>	140 <sup>1</sup>	39 <sup>1</sup>	9,1 <sup>1</sup>	89 <sup>1</sup>	44 56	40	3,3
						2110 <sup>1</sup>	270 <sup>1</sup>	75 <sup>1</sup>	34,4 <sup>1</sup>	338 <sup>1</sup>			
						1015 <sup>2</sup>	100 <sup>2</sup>	28 <sup>2</sup>	8,5 <sup>2</sup>	84 <sup>2</sup>			
						1810 <sup>2</sup>	210 <sup>2</sup>	58 <sup>2</sup>	31 <sup>2</sup>	304 <sup>2</sup>			

<sup>1</sup>Rear air outlet. <sup>2</sup>Side air outlet with high profile.





## VORT PRESS I EP RANGE | TECHNICAL DATA FOR REGULATION N° 1254/2014/UE

	UNIT OF MEASURE	VORT PRESS 110 LL I	VORT PRESS 140 LL I
Supplier's name or trade mark	-	Vortice	Vortice
Specific Energy Consumption class SEC in average climate zone	-	NA	NA
Specific Energy Consumption class SEC average	-	-5,1	-5,8
Specific Energy Consumption class SEC cold	kWh/m <sup>2</sup> year	-18,5	-19,2
Specific Energy Consumption class SEC warm	-	2,5	1,8
Declared typology	-	RVU-U*	RVU-U*
Type of drive	-	NA	NA
Type of heat recovery system HRS	-	none	none
Thermal efficiency of heat recovery at reference air flow	%	NA*	NA*
Maximum flow rate	m <sup>3</sup> /h	117	133
Electric power input of the fan drive, including any motor control equipment, at maximum flow rate	W	23,1	23,5
Sound power level LWA	LWA [DB(A)]	62	59
Reference flow rate	m <sup>3</sup> /s	0,0228	0,0259
Reference pressure difference	Pa	66	88
SPI	W/(m <sup>3</sup> /h)	0,25641	0,23631
Control factor CTRL	-	1	1
Control typology	-	manual	manual
Maximum internal leakage rates	%	NA	NA
Maximum external leakage rates	%	NA	NA
Mixing rate	-	NA	NA
Position and description of visual filter warning	-	NA	NA
Airflow sensitivity to pressure variations at + 20 Pa and - 20 Pa	-	NA	NA
Indoor/outdoor air tightness	m <sup>3</sup> /h	NA	NA
Annual electricity consumption (AEC)	kWh electricity/year	353	326
AHS average Annual heating saved	-	1397	1397
AHS cold Annual heating saved	kWh primary energy/year	2732	2732
AHS warm Annual heating saved	-	632	632

	UNIT OF MEASURE	VORT PRESS 240 LL
Supplier's name or trade mark	-	Vortice
Declared typology	-	NRVU-U*
Type of drive	-	VSD****
Type of heat recovery system HRS	-	None
Thermal efficiency of heat recovery	-	NA
Nominal NRVU flow rate	m <sup>3</sup> /s	0,07444
Effective electric power input	kW	0,045
SFPint	W/(m <sup>3</sup> /h)	569,91
Face velocity at design flow rate	m/s	10,07393
Nominal external pressure ( $\Delta p_{s,int}$ )	Pa	10
Internal pressure drop of ventilation components ( $\Delta p_{s,int}$ )	Pa	165
Internal pressure drop of non-ventilation components ( $\Delta p_{s,int}$ )	Pa	0
Static efficiency of fans used in accordance with Regulation (EU) N. 3272011	%	29
Declared maximum internal leakage rate of the casing of ventilation units	%	NA
Declared maximum external leakage rate of the casing of ventilation units	%	NA
Energy performance energy or classification of the filters	-	NA
Description of visual filter warning	%	NA
Casing sound power level (LWA)	dB(A)	56

\* RVU-U: Unit Ventilation Residential - Unidirectional \*\* NRVU-U: Unit Ventilation Non Residential - Unidirectional \*\*\* MSD: Multi-Speed Drive \*\*\*\* VSD: Variable-Speed Drive NA: Not applicable



## RESIDENTIAL VENTILATION

VORT PRESS I RANGE

### DIMENSIONS

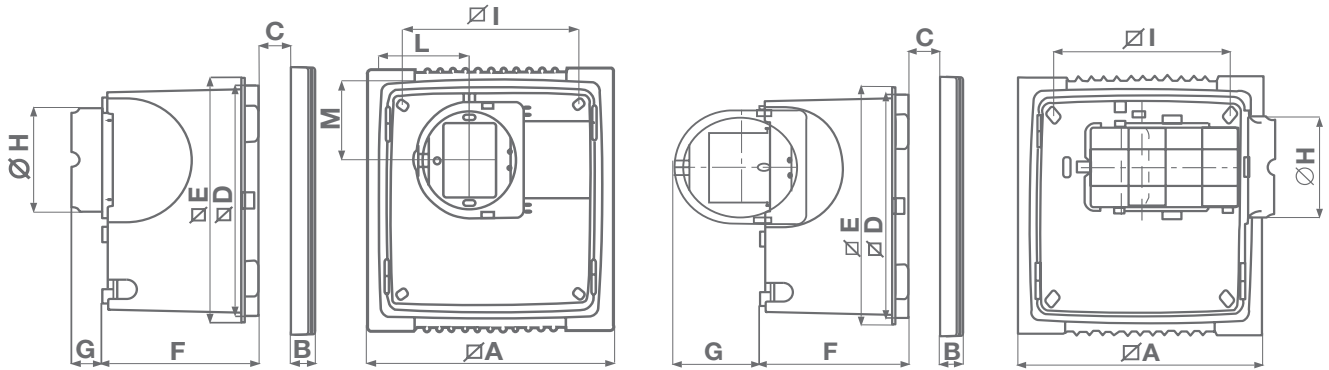

MODEL	∅ A	B	C	∅ D	∅ E	F	G	H	∅ I	L	M
VORT PRESS 110 LL I	252	23	65	214,5	228	135,5	31,5 76,7	96,5	180	92	76

Dimensions (mm)

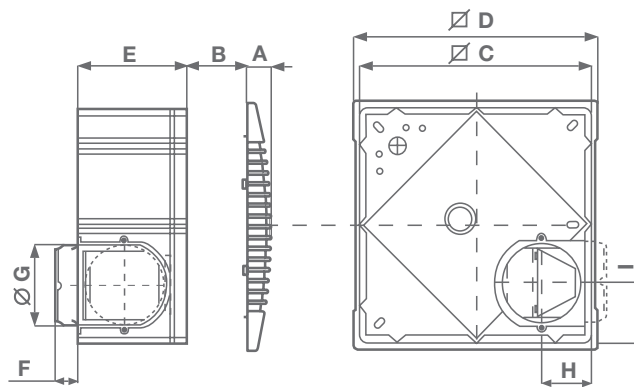

MODEL	A	∅ B	∅ C	∅ D	E	F	G	H	∅ I
VORT PRESS 140 LL I	28	65	284	300	133	28,5	97	62	71,5
VORT PRESS 240 LL I	28	65	284	300	133	28,5	97	62	71,5

Dimensions (mm)

### PERFORMANCE CURVES

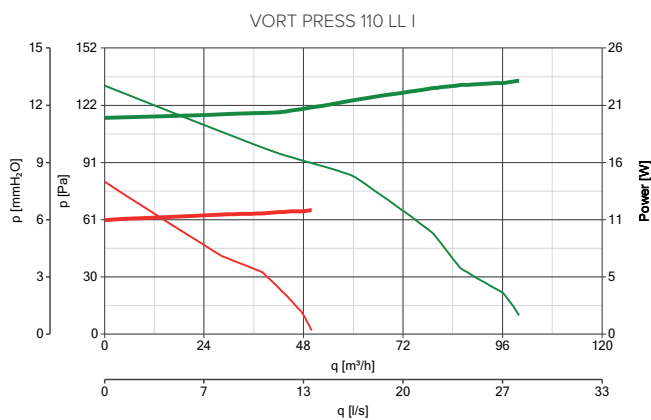

PERFORMANCE CURVES  
 — min  
 — max

POWER CONSUMPTION  
 — min  
 — max



PERFORMANCE CURVES

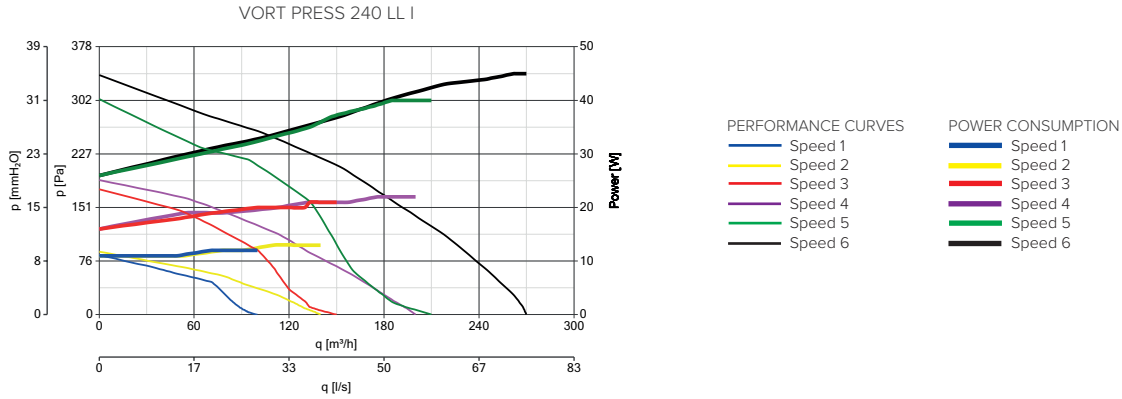

CONTROLLER

MODELS	DESCRIPTION	CODE	PRODUCT
	<b>C 1.5</b> - Electronic speed controller 1.5 A	12966	12010
	<b>SCNRB</b> - Electronic speed controller built-in	12971	ALL PRODUCTS
	<b>SCB KIT</b> - Built-in controller adaptor for C 1.5	22481	12966
	<b>POT-IT</b> - Potentiometer equipped with On/Off switch, for installation in 503 Standard Box.	12826	11977 - 11978
	<b>POT</b> - Potentiometer for installation in Standard DIN box.	12828	11977 - 11978

ACCESSORIES ON REQUEST

MODELS	DESCRIPTION	CODE	PRODUCT
	<b>HORIZONTAL OUTLET - LOW PROFILE</b>	22842	ALL PRODUCTS
	<b>HORIZONTAL OUTLET - HIGH PROFILE</b>	22841	ALL PRODUCTS
	<b>FALSE-CEILING/WALL INSTALLATION KIT</b>	22823	ALL PRODUCTS
	<b>VP-C - KIT FOR FALSE CEILING INSTALLATIONS (MAX HEIGHT 40 CM).</b>	22815	11971 - 11972



## VORT QUADRO RANGE

### Centrifugal duct fans

For the ventilation of medium-sized or large rooms in commercial premises plus bathrooms, showers, toilets, utilities and kitchens in domestic situations.

- **13 models:** 11 with or without timer and incorporated humidistat, 2 high-efficiency EC-DC brushless motor.
- Motor with thermal cut-out incorporated.
- Backdraught shutter already installed on the product to avoid air back-flow when the unit is turned off.
- Vort Quadro fans guarantee a low environmental impact. Recyclable materials have been used and the "Design for Disassembly" technique has been followed.
- The units have a high extraction to long ducts are used. Reduced sound levels with superior certified performances on ducted applications.
- The energy saving can be really significant in case of continuous operation of the fan.
- It will also permit power savings associated with the recovery of heat.
- Timer models adjustable between 3 and 20 min.
- T-HCS model, adjustable RH threshold at 60%, 70%, 80%, 90% by mean of a slide switch during installation. The product automatically switches on when the indoor relative humidity level exceeds the pre-set value.
- Filter can be removed and washed.
- Easy to install and maintain.
- Data and performances IMQ Performance certified.
- Protection rating: IPX4.
- Insulation class: II .

Design: F. Trabucco & Associates



#### RANGE

	BASE	TIMER	TIMER HCS
<b>MICRO 80</b>	<b>11638</b> MICRO 80	<b>11648</b> MICRO 80 T	-
<b>MICRO 100</b>	<b>11936</b> MICRO 100 <b>11937</b> MICRO 100 ES	<b>11940</b> MICRO 100 T <b>11941</b> MICRO 100 T ES	<b>11945</b> MICRO 100 THCS
<b>MEDIO</b>	<b>11944</b> MEDIO	<b>11946</b> MEDIO T	<b>11975</b> MEDIO THCS
<b>SUPER</b>	<b>11952</b> SUPER	<b>11954</b> SUPER T	<b>11989</b> SUPER THCS



## TECHNICAL DATA

MODELS	V~50HZ	W min/max	A min/max	RPM min/max	MAX AIRFLOW		MAX PRESSURE		Lp dB(A) 3m min/max	MAX °C	KG
					m³/h min/max	l/s min/max	mmH₂O min/max	Pa min/max			
MICRO 80	220-240	19 27	0,10 0,13	1150 1580	60 85	17 24	22 27	216 265	28,7 37,0	50	1,79
MICRO 100	220-240	20 28	0,10 0,13	1180 1600	65 90	18 25	16 22	157 216	32,3 39,2	50	1,80
MICRO 100 ES	220 - 240	8 15	0,08 0,12	1235 1630	65 90	18 25	9 18	88 177	34,5 37,4	50	1,80
MEDIO	220-240	25 29	0,14 0,18	1150 1890	70 120	19 33	22 34	216 329	36,7 43,4	50	2,50
SUPER	220-240	50 105	0,36 0,50	1400 2200	140 280	38 77	23 50	226 490	41,9 48,6	50	3,77

## VORT QUADRO RANGE | TECHNICAL DATA FOR REGULATION N° 1254/2014/UE

	UNIT OF MEASURE	MICRO 80	MICRO 100	MEDIO
Supplier's name or trade mark	-	Vortice	Vortice	Vortice
Specific Energy Consumption class SEC in average climate zone	-	NA	NA	NA
Specific Energy Consumption class SEC average		-0,5	0,0	0
Specific Energy Consumption class SEC cold	kWh/m² year	-13,9	-13,3	-14
Specific Energy Consumption class SEC warm		7,2	7,7	7
Declared typology	-	RVU-U**	RVU-U**	RVU-U**
Type of drive	-	NA	NA	VSD****
Type of heat recovery system HRS	-	none	none	none
Thermal efficiency of heat recovery at reference air flow	%	NA	NA	NA
Maximum flow rate	m³/h	95	92	103
Electric power input of the fan drive, including any motor control equipment, at maximum flow rate	W	28,7	28,1	29,4
Sound power level LWA	LWA [DB(A)]	58	60	64
Reference flow rate	m³/s	0,0185	0,0179	0,0286
Reference pressure difference	Pa	148	196	141
SPI	W/(m³/h)	0,39098	0,40683	0,398
Control factor CTRL	-	1	1	1
Control typology	-	manual	manual	manual
Maximum internal leakage rates	%	NA	NA	NA
Maximum external leakage rates	%	NA	NA	NA
Mixing rate	-	NA	NA	NA
Position and description of visual filter warning	-	NA	NA	NA
Airflow sensitivity to pressure variations at + 20 Pa and - 20 Pa	-	NA	NA	0,10
Indoor/outdoor air tightness	m³/h	NA	NA	NA
Annual electricity consumption (AEC)	kWh electricity/year	539	561	549
AHS average Annual heating saved		1397	1397	1397
AHS cold Annual heating saved	kWh primary energy/year	2732	2732	2732
AHS warm Annual heating saved		632	632	632

\* RVU-U: Unit Ventilation Residential - Unidirectional

\*\* NRVU-U: Unit Ventilation Non Residential - Unidirectional

\*\*\* MSD: Multi-Speed Drive

\*\*\*\*VSD: Variable-Speed Drive

NA: Not applicable



## RESIDENTIAL VENTILATION

### VORT QUADRO RANGE

#### VORT QUADRO RANGE | TECHNICAL DATA FOR REGULATION N° 1254/2014/UE

	UNIT OF MEASURE	SUPER
Supplier's name or trade mark	-	Vortice
Declared typology	-	NRVU-U**
Type of drive		VSD***
Type of heat recovery system HRS	-	None
Thermal efficiency of heat recovery	-	NA
Nominal NRVU flow rate	m <sup>3</sup> /s	0,05556
Effective electric power input	kW	0,090
SFPint	W/(m <sup>3</sup> /h)	NA
Face velocity at design flow rate	m/s	7,528
Nominal external pressure ( $\Delta p_{s,int}$ )	Pa	200
Internal pressure drop of ventilation components ( $\Delta p_{s,int}$ )	Pa	245
Internal pressure drop of non-ventilation components ( $\Delta p_{s,int}$ )	Pa	0
Static efficiency of fans used in accordance with Regulation (EU) N. 3272011	%	27,5
Declared maximum internal leakage rate of the casing of ventilation units	%	NA
Declared maximum external leakage rate of the casing of ventilation units	%	4,2
Energy performance energy or classification of the filters	-	NA
Description of visual filter warning	%	NA
Casing sound power level (LWA)	dB(A)	69

\* RVU-U: Unit Ventilation Residential - Unidirectional

\*\* NRVU-U: Unit Ventilation Non Residential - Unidirectional

\*\*\* VSD: Variable-Speed Drive



DIMENSIONS

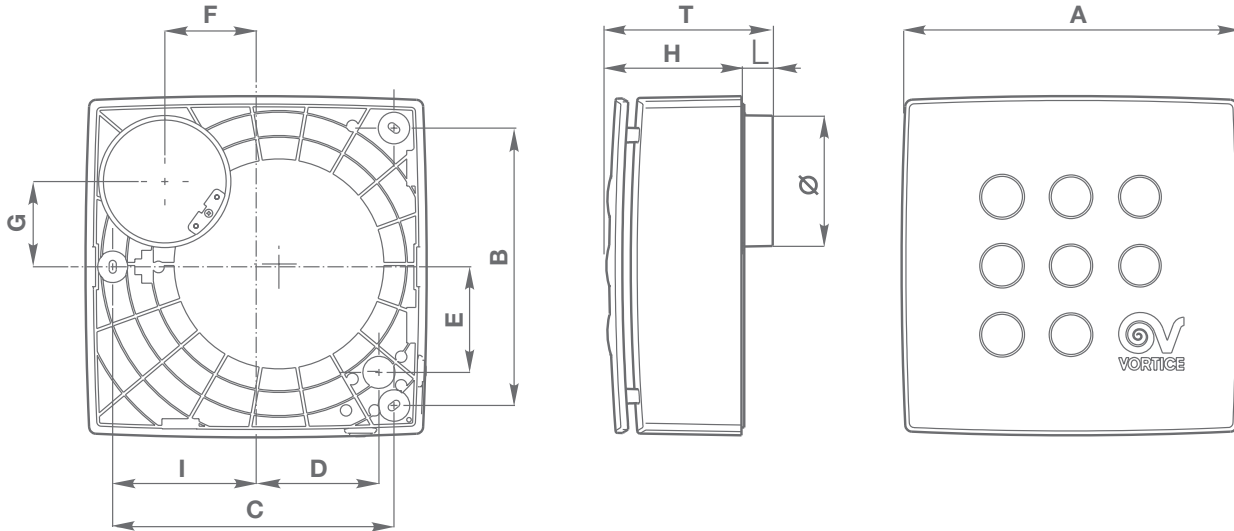

MODELS	□ A	B	C	D	E	F	G	H	I	L	T	∅
MICRO 80	239	195	197	85	74	64	60	97	100	20	117	73.5
MICRO 100	239	195	197	85	74	64	60	97	100	20	117	92.5/97

Dimensions (mm)

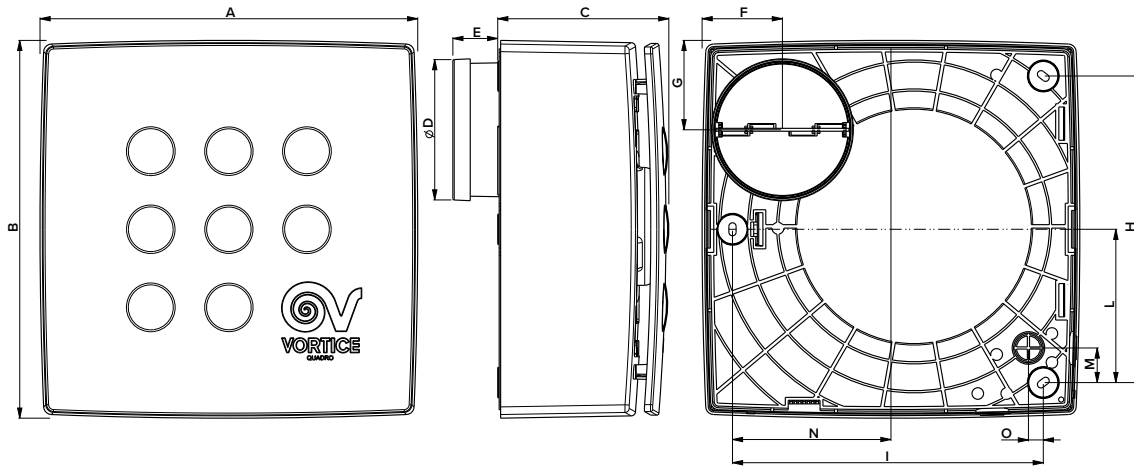

MODELS	□ A	B	C	D	E	F	G	H	I	L	M	N	O
MEDIO	261	261	119	97	31	55,5	62	212	215	106	24	110	10
SUPER	290	290	144	97	31	58	64	236	239	118	26	125	6,5

Dimensions (mm)





# RESIDENTIAL VENTILATION

VORT QUADRO RANGE

## PERFORMANCE CURVES

MICRO 80

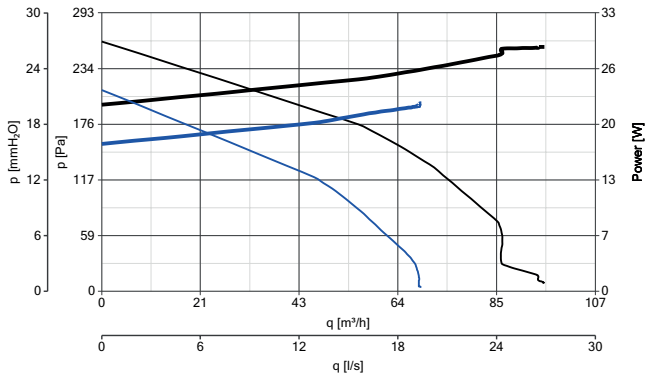

MICRO 100

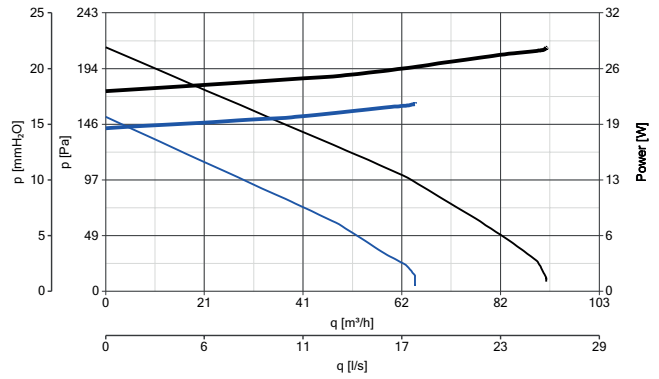

MICRO 100 ES

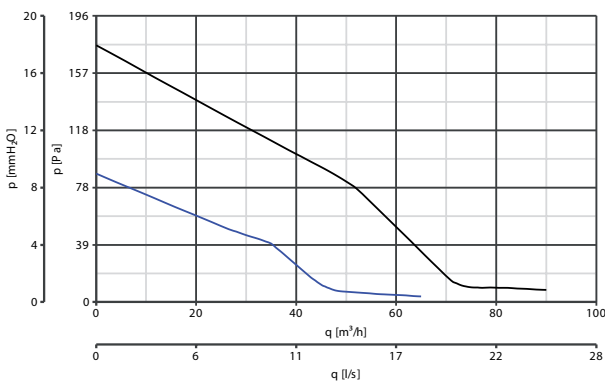

PERFORMANCE CURVES  
 — max  
 — min  
 POWER CONSUMPTION  
 — max  
 — min

MEDIO

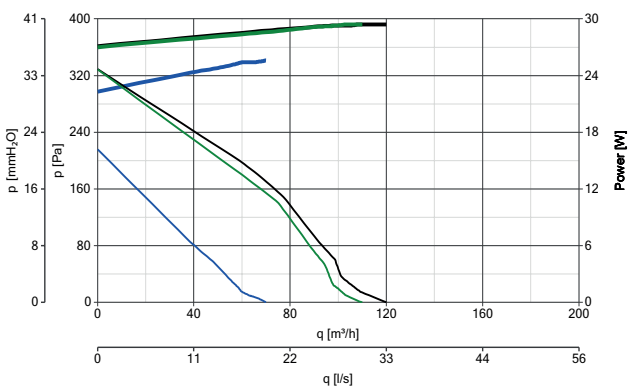

PERFORMANCE CURVES  
 — Speed 1  
 — Speed 2  
 — Speed 3  
 POWER CONSUMPTION  
 — Speed 1  
 — Speed 2  
 — Speed 3

SUPER

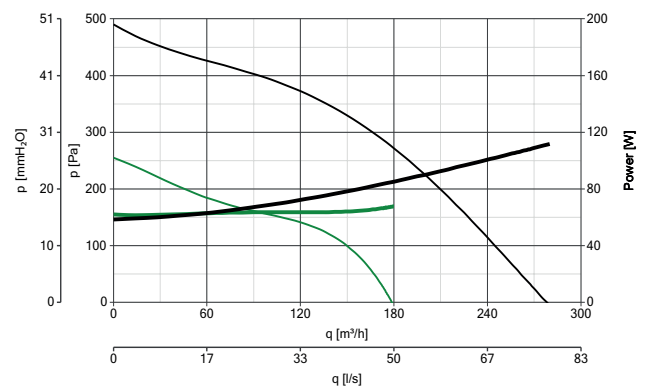

PERFORMANCE CURVES  
 — min  
 — max  
 POWER CONSUMPTION  
 — min  
 — max



## CONTROLLER

MODELS	DESCRIPTION	CODE	PRODUCT
	<b>C 1.5</b> - Electronic speed controller 1.5 A	12966	ALL PRODUCTS
	<b>SCNRB</b> - Electronic speed controller built-in	12971	ALL PRODUCTS
	<b>SCB KIT</b> - Built-in controller adaptor for C 1.5	22481	12966
	<b>TRIO</b> - Built-in controller adaptor for C 1.5	12871	11952 - 11954 - 11989

## ACCESSORIES ON REQUEST

MODELS	DESCRIPTION	CODE	PRODUCT
	<b>AIR DEFLECTOR</b>	100/4 22310	ALL PRODUCTS

## APPLICATIONS

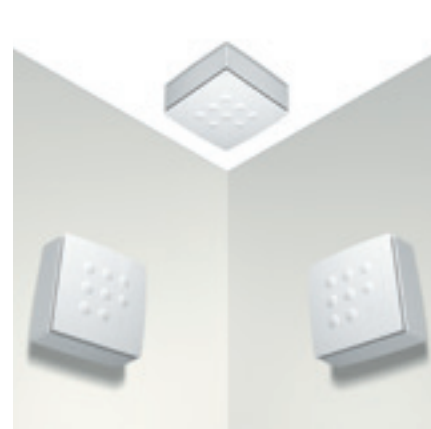



## VORT QUADRO I RANGE

Centrifugal duct fans for flush mounting

For the ventilation of medium-sized or large rooms in commercial premises plus bathrooms, showers, toilets, utilities and kitchens in domestic situations.

- **11 models:** 6 without timer, 4 with timer 3 with timer and incorporated humidistat and 2 with energy saving EC-DC brushless motor
- Flush mounting.
- Motor with thermal cut-out incorporated.
- Backdraught shutter already installed on the product to avoid air back-flow when the unit is turned off.
- The units have a high extraction to long ducts are used. Reduced sound levels with superior certified performances on ducted applications.
- The energy saving can be really significant in case of continuous operation of the fan.
- It will also permit power savings associated with the recovery of heat.
- Timer models adjustable between 3 and 20 min.
- T-HCS model, adjustable RH threshold at 60%, 70%, 80%, 90% by mean of a slide switch during installation. The product automatically switches on when the indoor relative humidity level exceeds the pre-set value
- Filter can be removed and washed.
- Easy to install and maintain.
- Data and performances IMQ Performance certified.
- Protection rating: IPX4.
- Insulation class: II

Design: F. Trabucco & Associates



RANGE

	BASE	TIMER	TIMER HCS
<b>MICRO 100 I</b>	<b>12017</b> MICRO 100 I <b>12045</b> MICRO 100 I ES	<b>12018</b> MICRO 100 I T <b>12046</b> MICRO 100 I T ES	<b>12065</b> MICRO 100 I T HCS
<b>MEDIO I</b>	<b>12020</b> MEDIO I	<b>12021</b> MEDIO I T	<b>12066</b> MEDIO I T HCS
<b>SUPER I</b>	<b>12023</b> SUPER I	<b>12024</b> SUPER I T	<b>12067</b> SUPER I T HCS



## TECHNICAL DATA

MODELS	V~50HZ	W min/max	A min/max	RPM min/max	MAX AIRFLOW		MAX PRESSURE		Lp dB(A) 3m min/max	MAX °C	KG
					m³/h min/max	l/s min/max	mmH <sub>2</sub> O min/max	Pa min/max			
MICRO 100 I	220-240	20 27	0,10 0,12	1010 1450	75 100	21 28	20 22	196 218	26,3 34,3	50	1,91
MICRO 100 I ES	220-240	8 15	0,08 0,12	1090 1430	75 100	21 28	9 18	88 177	31,8 38,4	50	1,91
MEDIO I	220-240	25 29	0,14 0,18	1150 1890	70 122	19 34	21 34	206 331	35,9 41,2	50	2,8
SUPER I	220-240	50 115	0,36 0,50	1280 2190	140 285	38 79	20 48	196 476	33,6 46,7	50	4,27

## VORT QUADRO I RANGE | TECHNICAL DATA FOR REGULATION N° 1254/2014/UE

	UNIT OF MEASURE	MICRO 100 I	MEDIO I
Supplier's name or trade mark	-	Vortice	Vortice
Specific Energy Consumption class SEC in average climate zone	-	NA	NA
Specific Energy Consumption class SEC average	-	-15,0	-14
Specific Energy Consumption class SEC cold	kWh/m <sup>2</sup> year	-1,7	-1
Specific Energy Consumption class SEC warm	-	6,0	7
Declared typology	-	RVU-U*	RVU-U*
Type of drive	-	NA	MSD
Type of heat recovery system HRS	-	none	none
Thermal efficiency of heat recovery at reference air flow	%	NA	NA
Maximum flow rate	m <sup>3</sup> /h	100	106
Electric power input of the fan drive, including any motor control equipment, at maximum flow rate	W	27,0	29,6
Sound power level LWA	LWA [DB(A)]	54	62
Reference flow rate	m <sup>3</sup> /s	0,0194	0,02944
Reference pressure difference	Pa	95	196
SPI	W/(m <sup>3</sup> /h)	0,35714	0,384
Control factor CTRL	-	1	1
Control typology	-	manual	manual
Maximum internal leakage rates	%	NA	NA
Maximum external leakage rates	%	NA	NA
Mixing rate	-	NA	NA
Position and description of visual filter warning	-	NA	NA
Airflow sensitivity to pressure variations at + 20 Pa and - 20 Pa	-	NA	0,06
Indoor/outdoor air tightness	m <sup>3</sup> /h	NA	NA
Annual electricity consumption (AEC)	kWh electricity/year	492	529
AHS average Annual heating saved	-	1397	1397
AHS cold Annual heating saved	kWh primary energy/year	2732	2732
AHS warm Annual heating saved	-	632	632

\* RVU-U: Unit Ventilation Residential - Unidirectional

\*\* NRVU-U: Unit Ventilation Non Residential - Unidirectional

\*\*\* MSD: Multi-Speed Drive

NA: Not applicable



## RESIDENTIAL VENTILATION

### VORT QUADRO I RANGE

#### VORT QUADRO I AC RANGE | TECHNICAL DATA FOR REGULATION N° 1254/2014/UE

	UNIT OF MEASURE	SUPER I
Supplier's name or trade mark	-	Vortice
Declared typology	-	NRVU-U**
Type of drive		VSD***
Type of heat recovery system HRS	-	None
Thermal efficiency of heat recovery	-	NA
Nominal NRVU flow rate	m <sup>3</sup> /s	0,05833
Effective electric power input	kW	0,095
SFPint	W/(m <sup>3</sup> /h)	NA
Face velocity at design flow rate	m/s	7,894
Nominal external pressure ( $\Delta p_{s,int}$ )	Pa	205
Internal pressure drop of ventilation components ( $\Delta p_{s,int}$ )	Pa	245
Internal pressure drop of non-ventilation components ( $\Delta p_{s,int}$ )	Pa	0
Static efficiency of fans used in accordance with Regulation (EU) N. 3272011	%	27,6
Declared maximum internal leakage rate of the casing of ventilation units	%	NA
Declared maximum external leakage rate of the casing of ventilation units	%	NA
Energy performance energy or classification of the filters	-	NA
Description of visual filter warning	%	NA
Casing sound power level (LWA)	dB(A)	67

\* RVU-U: Unit Ventilation Residential - Unidirectional

\*\* NRVU-U: Unit Ventilation Non Residential - Unidirectional

\*\*\* VSD: Variable-Speed Drive

#### DIMENSIONS

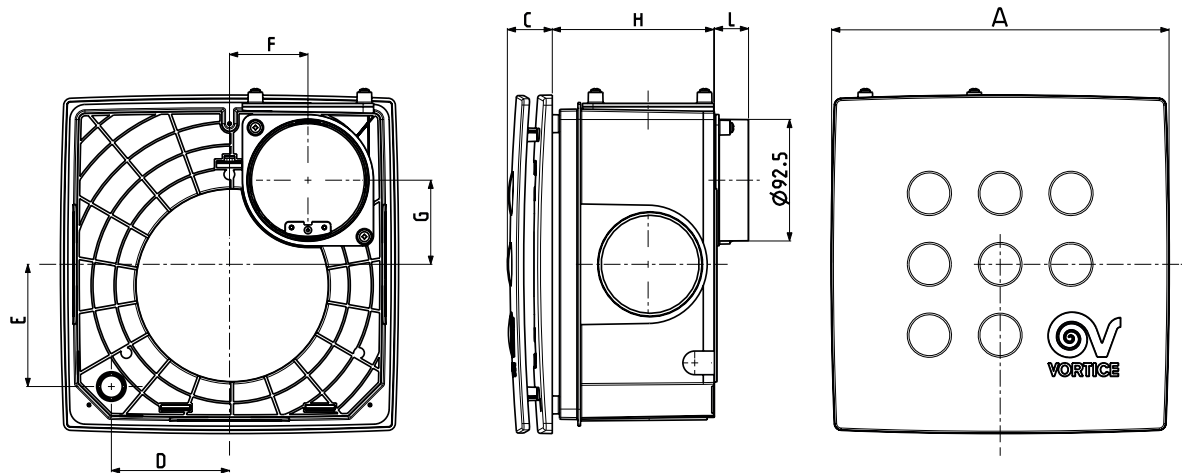

MODELS	A	C	D	E	F	G	H	L
MICRO 100 I	258	34	92	90	64	60	118	26
MICRO 100 I ES	258	34	92	90	64	60	118	26
MEDIO I	287	37	97	103	72	69	130	26

Dimensions (mm)



DIMENSIONS

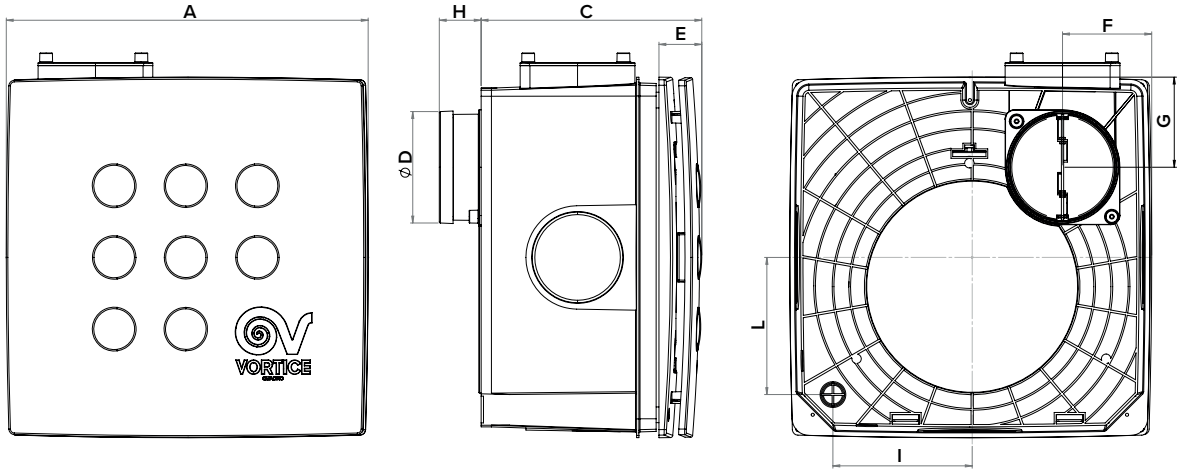

MODELS	A	C	D	E	F	G	H	I	L
SUPER	314	190	97	37	76	79	37	120	120

Dimensions (mm)

PERFORMANCE CURVES

MICRO 100 I

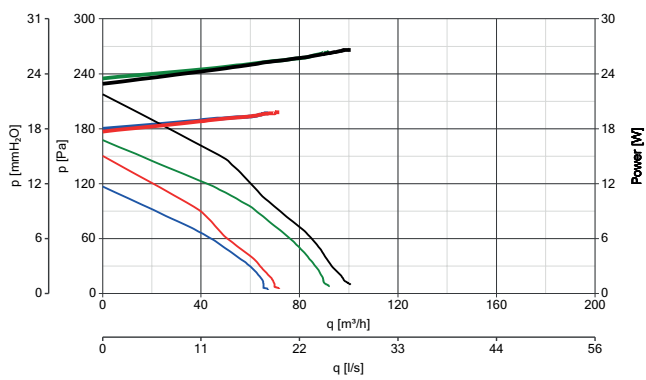

PERFORMANCE CURVES  
 — Speed 1  
 — Speed 2  
 — Speed 3  
 — Speed 4

POWER CONSUMPTION  
 — Speed 1  
 — Speed 2  
 — Speed 3  
 — Speed 4

MICRO 100 I ES

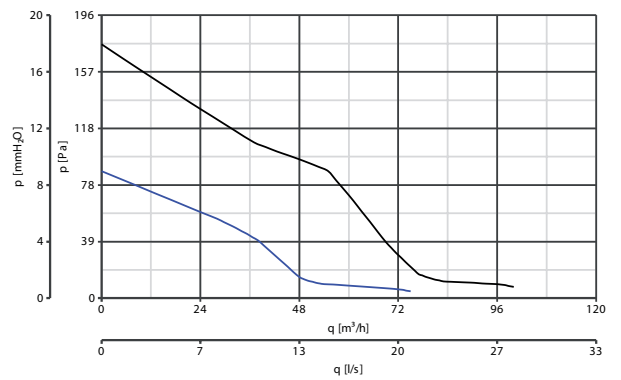

POWER CONSUMPTION  
 — min  
 — max

STATIC PRESSURE  
 — min  
 — max





## RESIDENTIAL VENTILATION

VORT QUADRO I RANGE

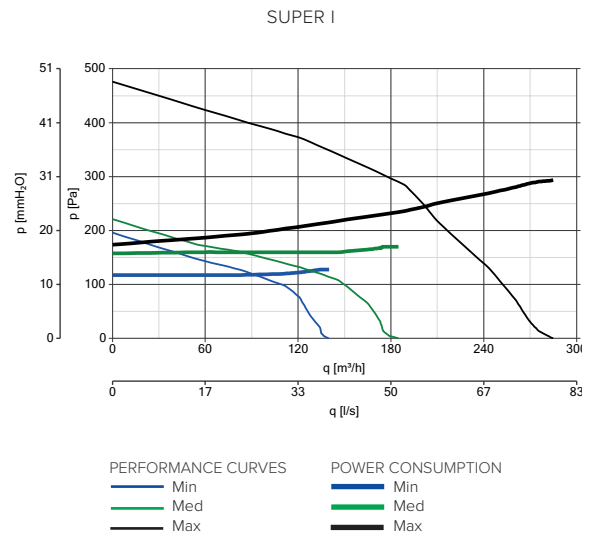
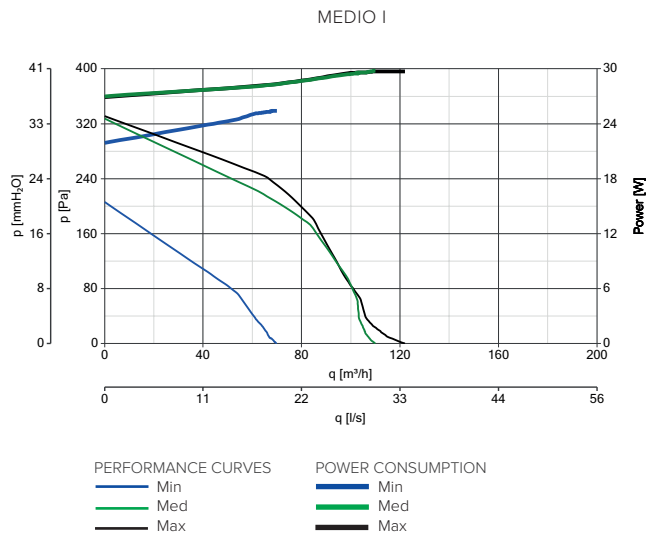

### PERFORMANCE CURVES



### CONTROLLER

MODELS	DESCRIPTION	CODE	PRODUCT
	<b>C 1.5</b> - RElectronic speed controller 1.5 A	12966	ALL PRODUCTS
	<b>SCNRB</b> - Electronic speed controller built-in	12971	ALL PRODUCTS
	<b>SCB KIT</b> - Bult-in controller adaptor for C 1.5	22481	12966
	<b>TRIO</b> - Bult-in controller adaptor for C 1.5	12871	12023 - 12024 - 12067

### ACCESSORIES ON REQUEST

MODELS	DESCRIPTION	CODE	PRODUCT
	<b>AIR DEFLECTOR</b>	100/4 22310	ALL PRODUCTS
	<b>CEILING KIT</b>	MICRO 100 I 22491	12017 - 12045 - 12018 - 12046 - 12065
		MEDIO I 22492	12020 - 12021 - 12066
		SUPER I 22493	12023 - 12024 - 12067





APPLICATIONS





## VORT QUADRO EVO RANGE

Residential centrifugal extractor fans

Suitable for wall/ceiling mounting or recessed installation; performance and fire resistance according to DIN 18017-3 standard. Ultra low noise levels perfectly compatible with night operation. High degree of protection (IP45), allowing safe installation in Zone 1 of bathrooms. Modular design: basic units can be combined to match a wide range of installation needs. High aerodynamic efficiency, granting full compliance with Erp Reg. n° 1253/2014, 2<sup>nd</sup> Tier.

- AC motor, shaft on ball bearings, granting continuous operation at least than 40.000 hours at max rated temperature.
- Forward curved centrifugal impeller, PBT made, granting high rigidity, dimensional stability and great resistance to aggressive chemical agents. Its high efficiency, resulting from accurate aerodynamics studies, grant high pressure levels at nominal airflows.
- Excellent sealing of backdraught shutter (TÜV Certified), to prevent the risk of bad smells and cold air diffusion when the product is switched off.
- Scroll, comprehending the electronic cardboard housing, made of self-extinguishing (V0) ABS.
- Aesthetic front panel, made of self-extinguishing (V0) ABS; perimeter extraction two A hinges allow a wide rotation angle for easy filter maintenance.
- Motor housing and filter frame made of ABS plastic.
- G2 filter, with clogged filter alarm, according to Erp. Reg. N° 1253/2014/Eu , 2nd Tier.
- Protection rating: IP45

### CASINGS

- 10 alternative casings, different for installation and fire protection.
- Integrated spigot (nominal diameters 80 mm) and a backdraught shutter.
- Frame to prevent entry of dirt and plaster at installation supplied with the product.

### RANGE

Modular concept allows to freely complete ventilation units and casing to match different needs. Vort Quadro Evo Range consists of 23 ventilation units, different for performances and features, and 10 casing, suitable for wall ceiling and flush mounting. Alternative levels of fire protection available.



#### VENTILATION UNITS:

23 models different for electronic Suite (5) and level of performance (5)

#### CASINGS EXTERNAL/RECESSED MOUNTINGS:

10 casings, different for installation and fire protection grade



## TECHNICAL DATA

Referred to Max, Mid, Min speed when available

MODELS	CODE	V~50HZ	W min/med/ max	A min/med/ max	RPM min/med/ max	MAX AIRFLOW		MAX PRESSURE		MAX °C	KG
						m³/h min/med/max	l/s min/med/max	mmH <sub>2</sub> O min/med/max	Pa min/med/max		
QE 60 LL	11521										
QE 60 LL T	11526										
QE 60 LL TP	11532	220 - 240	16	0.14	1170	60	16.7	35	343	50	2.33
QE 60 LL TP HCS	11537										
QE 60 LL T PIR	11544										
QE 60/35 LL	11523										
QE 60/35 LL T	11528										
QE 60/35 LL TP	11534	220 - 240	9 16	0.11 0.14	855 1170	35 60	9.7 16.7	10 35	98 343	50	2.33
QE 60/35 LL TP HCS	11541										
QE 60/35 LL T PIR	11546										
QE 100 LL	11522										
QE 100 LL T	11527										
QE 100 LL TP	11533	220 - 240	26	0.17	1570	100	27.8	36	353	50	2.33
QE 100 LL TP HCS	11538										
QE 100 LL T PIR	11545										
QE 100/60 LL	11524										
QE 100/60 LL T	11531										
QE 100/60 LL TP	11535	220 - 240	16 26	0.14 0.17	1170 1570	60 100	16.7 27.8	35 36	343 353	50	2.33
QE 100/60 LL TP HCS	11542										
QE 100/60 LL T PIR	11547										
QE 100/60/35 LL	11525										
QE 100/60/35 LL TP	11536	220 - 240	9 16 26 9	0.11 0.14 0.17	855 1170 1570	35 60 100	9.7 16.7 27.8	10 35 36	98 343 353	50	2.33
QE 100/60/35 LL TP HCS	11543										

## SOUNDS LEVELS

SOUND POWER  
L<sub>w</sub>A

Airflow m³/h	WALL MOUNTING			Airflow m³/h	RECESSED MOUNTING		
	100	60	35		100	60	35
dB(A)	50.5	43.7	33.7	dB(A)	50.2	42	32.7

SOUND PRESSURE\*  
L<sub>p</sub> dB(A) 2m

Airflow m³/h	WAL MOUNTING			Airflow m³/h	INSTALLAZIONE A INCASSO		
	100	60	35		100	60	35
dB(A)	39.0	32.2	22.2	dB(A)	38.7	30.5	21.2



## RESIDENTIAL VENTILATION

VORT QUADRO EVO RANGE

### CASING

Casings integrate a nominal 80 mm diameter spigot and a backdraught shutter. Casings are also provided with a frame to prevent entry of dirt and plaster.

#### BASIC FOR INSTALLATION ON WALLS AND CEILINGS



CODE	MODEL	DESCRIPTION
11561	QE - B M	Basic encasement for surface (wall/ceiling) installation, made of ABS plastic. Spigot made of ABS plastic, integrating the backdraught shutter compliant with DIN 18017-3, as certified by TUV German Institute.

#### BASIC FOR INSTALLATION ON WALLS AND CEILINGS WITH FIREPROOF (CLASS K90), BACKDRAUGHT SHUTTER



CODE	MODEL	DESCRIPTION
11563	QE - B M VK90	Basic encasement for surface (wall/ceiling) installation, made of ABS plastic. Stainless steel spigot, integrating the K90 fireproof valve, TUM certified according to DIN 18017-3. Backdraught shutter compliant with DIN 18017-3, as certified by TUV German Institute.

#### BASIC FOR RECESSED INSTALLATION



CODE	MODEL	DESCRIPTION
11560	QE - B I	Basic encasement for recessed installation, made of ABS plastic. Spigot made of ABS plastic, integrating the backdraught shutter compliant with DIN 18017-3, as certified by TUV German Institute. Square frame to prevent entry of dirt and plaster. Port to connect a spigot (QE-AD cod. 21118, available as accessory) to extract air from a second room. Possibility of drywall installation.

#### BASIC FOR RECESSED INSTALLATION WITH FIREPROOF CLASS K 90, BACKDRAUGHT SHUTTER



CODE	MODEL	DESCRIPTION
11562	QE - B I VK90	Basic encasement for recessed installation, made of ABS plastic. Stainless steel spigot, integrating the K90 fireproof valve, TUM certified according to DIN 18017-3. Backdraught shutter compliant with DIN 18017-3, as certified by TUV German Institute. Square frame to prevent entry of dirt and plaster. Port to connect a spigot (QE-AD cod. 21118, available as accessory) to extract air from a second room. Possibility of drywall installation.



## RECESSED MOUNTINGS

## RECESSED INSTALLATION FIREPROOF ENCASEMENT K 90, WITH FIREPROOF CLASS K 90 BACKDRAUGHT SHUTTER

	CODE	MODELS	DESCRIPTION
	11564	QE - B I K90 R	Fireproof K90 casing for recessed installation and rear discharge. Stainless steel spigot, integrating the K90 fireproof valve, TUM certified according to DIN 18017-3. Backdraught shutter compliant with DIN 18017-3, as certified by TUV German Institute Spigot nominal diameter: 80 mm. Square frame to prevent entry of dirt and plaster.
	11565	QE - B I K90 S	Fireproof K90 casing for recessed installation and side discharge. Stainless steel spigot, integrating the K90 fireproof valve, TUM certified according to DIN 18017-3. Backdraught shutter compliant with DIN 18017-3, as certified by TUV German Institute Spigot nominal diameter: 80 mm. Square frame to prevent entry of dirt and plaster.
	11566	QE - B I K90 R 2R	Fireproof K90 casing for recessed installation and rear discharge. Stainless steel spigot, integrating the K90 fireproof valve, TUM certified according to DIN 18017-3. Backdraught shutter compliant with DIN 18017-3, as certified by TUV German Institute Spigot nominal diameter: 80 mm. Square frame to prevent entry of dirt and plaster. Stainless steel spigot, on the right side, able to extract air from a second room.
	11567	QE - B I K90 R 2L	Fireproof K90 casing for recessed installation and rear discharge. Stainless steel spigot, integrating the K90 fireproof valve, TUM certified according to DIN 18017-3. Backdraught shutter compliant with DIN 18017-3, as certified by TUV German Institute Spigot nominal diameter: 80 mm. Square frame to prevent entry of dirt and plaster. Stainless steel spigot, on the left side, able to extract air from a second room.
	11568	QE - B I K90 S 2R	Fireproof K90 casing for recessed installation and side discharge. Stainless steel spigot, integrating the K90 fireproof valve, TUM certified according to DIN 18017-3. Backdraught shutter compliant with DIN 18017-3, as certified by TUV German Institute Spigot nominal diameter: 80 mm. Square frame to prevent entry of dirt and plaster. Stainless steel spigot, on the right side, able to extract air from a second room.
	11569	QE - B I K90 S 2L	Fireproof K90 casing for recessed installation and side discharge. Stainless steel spigot, integrating the K90 fireproof valve, TUM certified according to DIN 18017-3. Backdraught shutter compliant with DIN 18017-3, as certified by TUV German Institute. Spigot nominal diameter: 80 mm. Square frame to prevent entry of dirt and plaster. Stainless steel spigot, on the left side, able to extract air from a second room.



## RESIDENTIAL VENTILATION

VORT QUADRO EVO RANGE

### DIMENSIONS

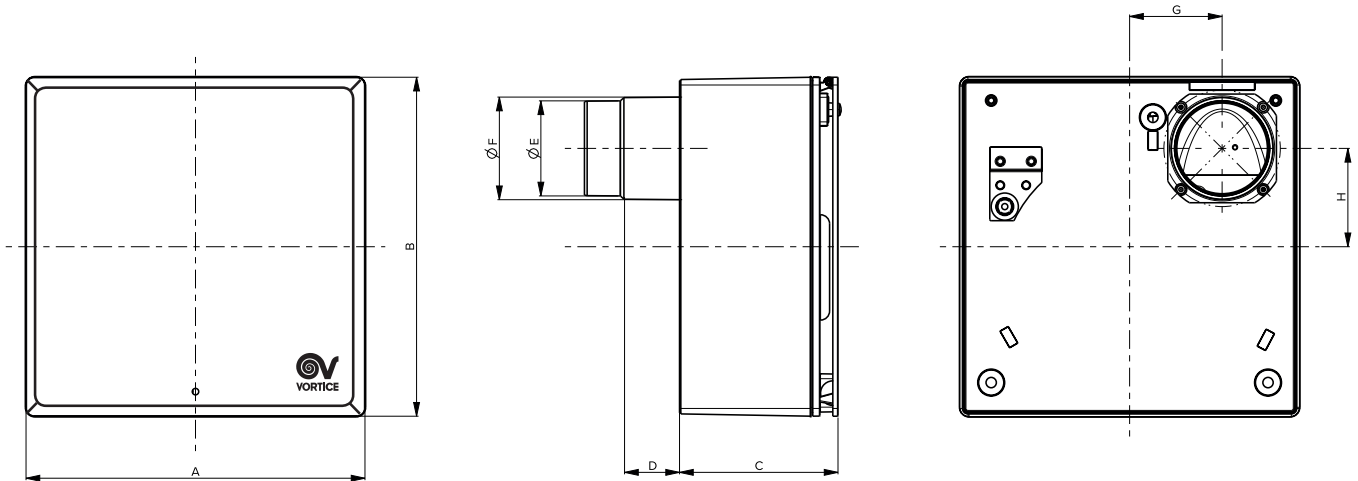

SURFACE MOUNTED VERSION

A	B	C	D	ØE	ØF	G	H
262	262	111,5	80	73	79	71,5	90

Dimensions (mm)

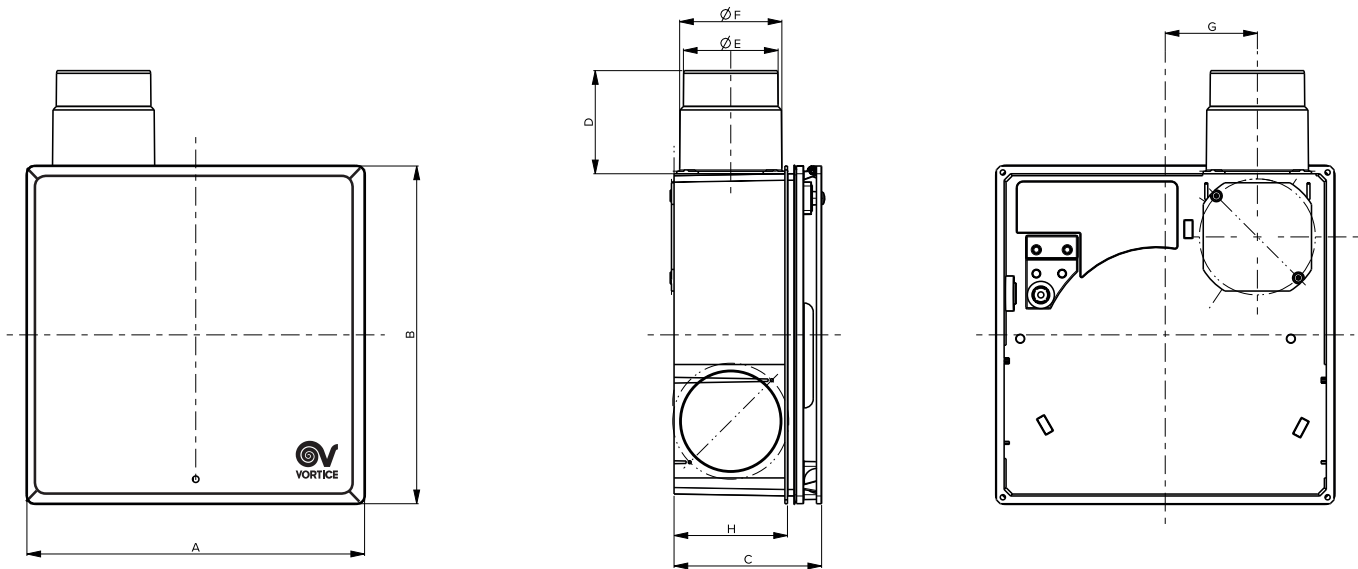

RECESSED VERSION

A	B	C	D	ØE	ØF	G	H
262	262	115,5	80	73	79	71,5	90

Dimensions (mm)



PERFORMANCE CURVES

QE 60

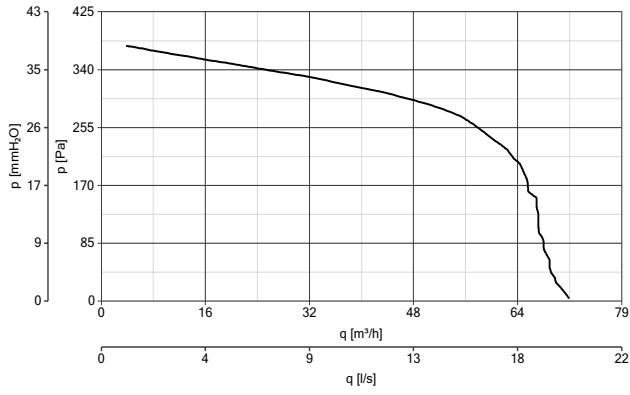

QE 60/35

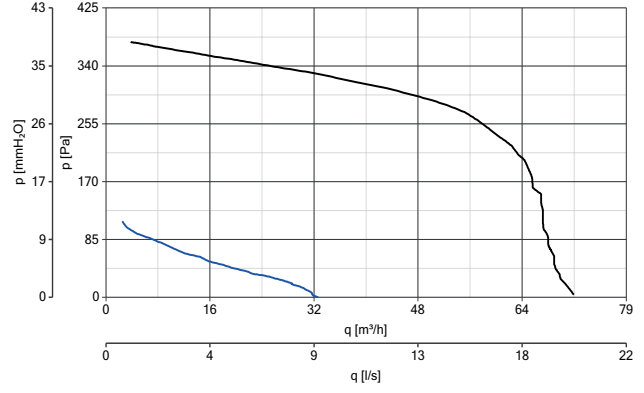

QE 100

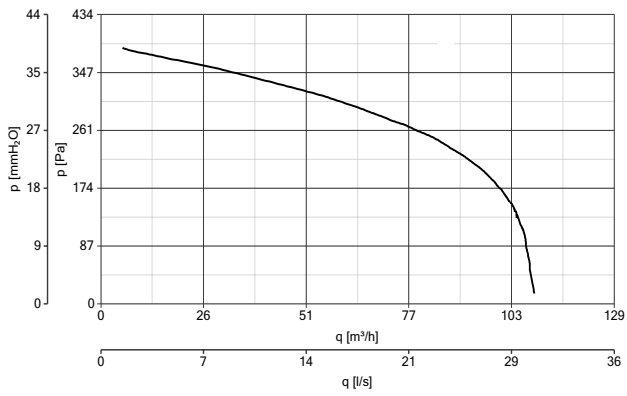

QE 100/60

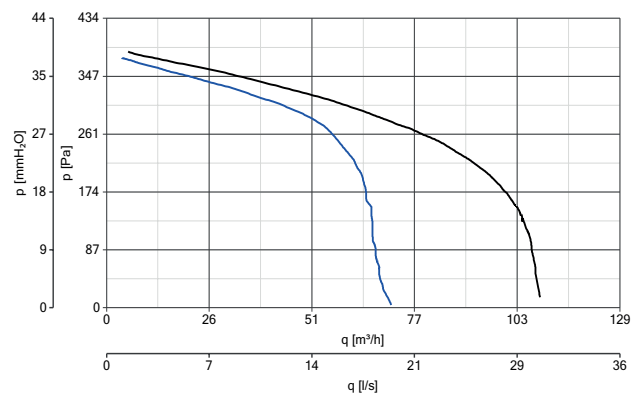

QE 100/60/35

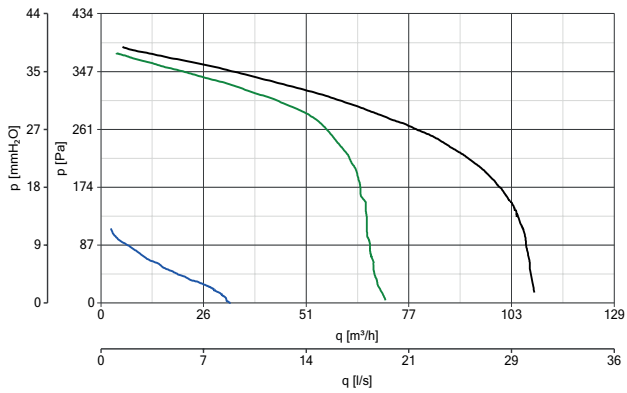

- MAX speed
- MID speed
- MIN speed

















## RESIDENTIAL VENTILATION

### VORT QUADRO EVO RANGE

#### CONTROLLER





MODELS	DESCRIPTION	CODE	PRODUCT
	<b>3SS - D</b> - 2 - 3 speeds switch for flush mounted installation, in a DIN Standard box	21132	11560 - 11561 - 11562 - 11563
	<b>2SS - I</b> - 2 speeds switch for flush mounted installation, in a UNI 503 Standard box	21133	11560 - 11561 - 11562 - 11563
	<b>3SS - I</b> - 3 speeds switch for flush mounted installation, in a UNI 503 Standard box	21134	11560 - 11561 - 11562 - 11563

#### ACCESSORIES ON REQUEST

MODELS	DESCRIPTION	CODE	PRODUCT
	<b>QE - MH</b> - Mounting holder for flush mounting in plasterboard systems	24127	11560 - 11562
	<b>QE - TEK</b> - Toilet extraction kit for WC	24128	11560 - 11562
	<b>QE - UMB</b> - Universal bracket for flush mounting in duct systems and false ceilings also for fireproof K90 casings	24094	11560 - 11562
	<b>QE - SRK</b> - Second room kit (including second room spigot)	24129	11560 - 11562
	<b>QE FBA</b> - Plasterboard adapter	24183	11560 - 11562
	<b>QE - AD</b> - Second room spigot	21118	11560 - 11562
	<b>QE - CFR</b> - Plasterboard cover	24229	11560 - 11562
	<b>QE - SPF</b> - Space frame	21101	11560 - 11562
	<b>SWAG</b> - White door grille	21119	11560 - 11561 - 11562 - 11563
	<b>SABG</b> - Brown door grille	21120	11560 - 11561 - 11562 - 11563



## ACCESSORIES ON REQUEST

MODELS	DESCRIPTION	CODE	PRODUCT	
	AVR - Fire dumper	AVR 100 mm	21121	11560 - 11561 - 11562 - 11563
		AVR 125 mm	21122	11560 - 11561 - 11562 - 11563
		AVR 140 mm	21123	11560 - 11561 - 11562 - 11563
		AVR 160 mm	21124	11560 - 11561 - 11562 - 11563
		AVR 180 mm	21125	11560 - 11561 - 11562 - 11563
		AVR 200 mm	21126	11560 - 11561 - 11562 - 11563
	MDV 100 - Manual air supply valve for 100 mm duct	21127	11560 - 11561 - 11562 - 11563	
	ADV 100 - Automatic air supply valve for 100 mm duct	21128	11560 - 11561 - 11562 - 11563	
	MSDV 100 - Manual air supply valve for 100 mm duct, with sound insulation	21129	11560 - 11561 - 11562 - 11563	
	ASDV 100 - Automatic air supply valve for 100 mm duct, with sound insulation	21130	11560 - 11561 - 11562 - 11563	

## APPLICATIONS



## VORT NOTUS RANGE

De-centralised continuous axial fans

Wide range of possible installations: through wall and ceiling.

- **2 models:** VORT NOTUS, VORT NOTUS T-HCS.
- Motor housing made of self-extinguishing (V0) polypropylene.
- Electrically controlled EC brushless motors offer optimal performance and extremely low energy consumption.
- Ball bearing motor.
- Flange, grille and front panel made of ABS.
- 3 levels of performance.
- Designed for continuous running.
- Very quiet running.
- In duct installation (Vort Notus only).
- Protection rating: IPX4.
- Insulation class: II .

### VORT NOTUS T-HCS:

- The R.H. sensor allows the automatic switch from minimum to maximum airflow when relative humidity exceeds the threshold setting (levels available: 60%, 70%, 80%, 90%).
- Timer function (activated by external switch) can be overrided the humidity detection system and run the product on boost speed.
- Timer adjustable between 3 and 20 minutes.



### TECHNICAL DATA

MODELS	CODE	V~50HZ	W min/max	A min/max	MAX AIRFLOW		MAX PRESSURE		Lp dB(A) 3m min/max	MAX °C	KG
					m <sup>3</sup> /h min/max	l/s min/max	mmH <sub>2</sub> O min/max	Pa min/max			
VORT NOTUS	11903	220-230	1,5 2,8	0,018 0,025	11,7 42,0	3,3 11,7	2,4 8,8	23,5 86,3	10,1 17,3	50	0,80
VORT NOTUS T-HCS	11177	220	2,1 6,4	0,028 0,037	11,7 42,0	3,3 11,7	2,4 8,8	23,5 86,3	10,1 17,3	50	0,80

\* Conforms with ISO 3744 for noise and pressure levels.



## VORT NOTUS RANGE | TECHNICAL DATA FOR REGULATION N° 1254/2014/UE

	UNIT OF MEASURE	VORT NOTUS - VORT NOTUS T-HCS
Supplier's name or trade mark	-	Vortice
Specific Energy Consumption class SEC in average climate zone	-	NA
Specific Energy Consumption class SEC average	-	-6,2
Specific Energy Consumption class SEC cold	kWh/m <sup>2</sup> year	-19,5
Specific Energy Consumption class SEC warm	-	1,5
Declared typology	-	RVU-U*
Type of drive	-	NA
Type of heat recovery system HRS	-	none
Thermal efficiency of heat recovery at reference air flow	%	NA
Maximum flow rate	m <sup>3</sup> /h	43
Electric power input of the fan drive, including any motor control equipment, at maximum flow rate	W	3,5
Sound power level LWA	LWA [DB(A)]	32,4
Reference flow rate	m <sup>3</sup> /s	0.0084
Reference pressure difference	Pa	62
SPI	W/(m <sup>3</sup> /h)	0.22591
Control factor CTRL	-	1
Control typology	-	manual
Maximum internal leakage rates	%	NA
Maximum external leakage rates	%	NA
Mixing rate	-	NA
Position and description of visual filter warning	-	NA
Airflow sensitivity to pressure variations at + 20 Pa and - 20 Pa	-	NA
Indoor/outdoor air tightness	m <sup>3</sup> /h	NA
Annual electricity consumption (AEC)	kWh electricity/year	311
AHS average Annual heating saved	-	1397
AHS cold Annual heating saved	kWh primary energy/year	2732
AHS warm Annual heating saved	-	632

\* RVU-U: Unit Ventilation Residential - Unidirectional

\*\* NRVU-U: Unit Ventilation Non Residential - Unidirectional

\*\*\* MSD: Multi-Speed Drive

NA: Not applicable

## DIMENSIONS

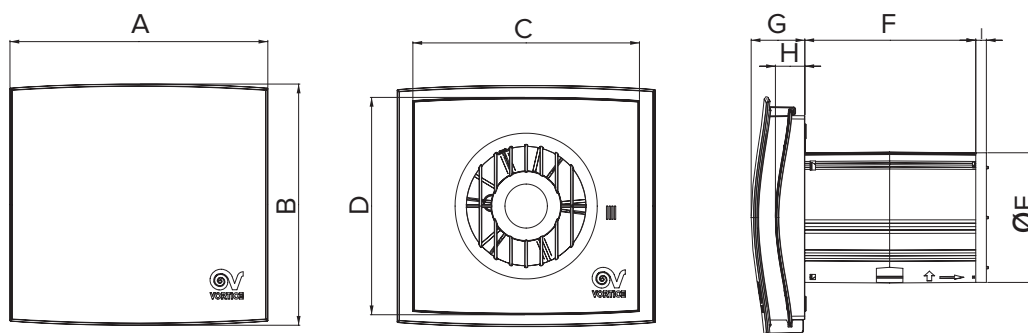

MODELS	A	B	C	D	ØE	F	G	H	I
VORT NOTUS	194,5	182	171	164	97,8	129	40,5	22,2	8
VORT NOTUS T-HCS	194,5	182	171	164	97,8	129	40,5	22,2	8

Dimensions (mm)



## RESIDENTIAL VENTILATION

VORT NOTUS RANGE

### PERFORMANCE CURVES

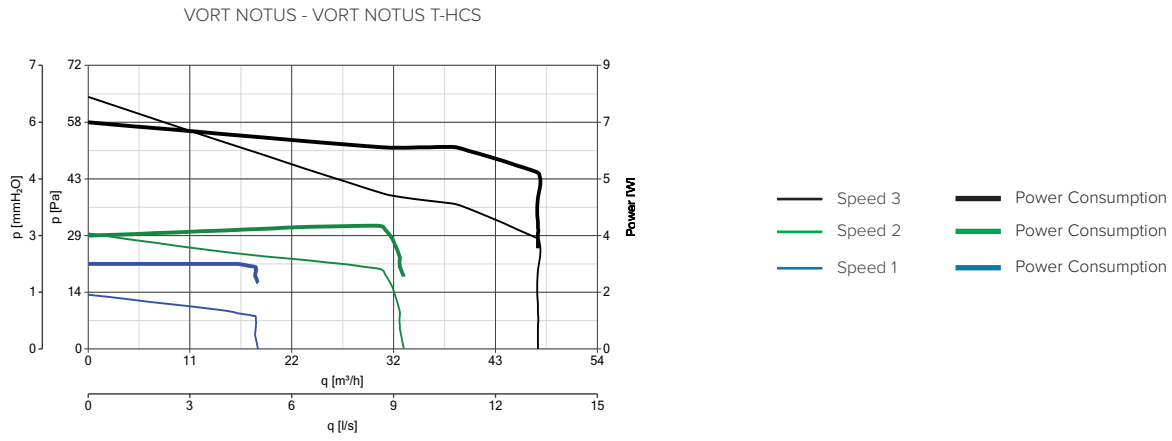

### APPLICATIONS

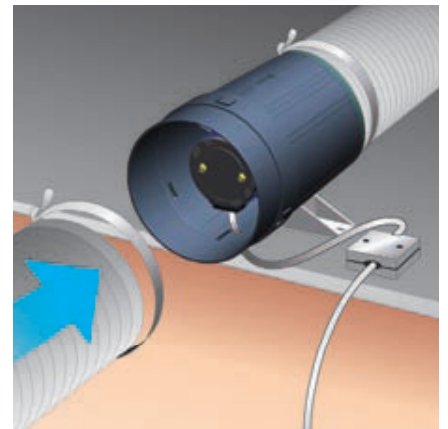
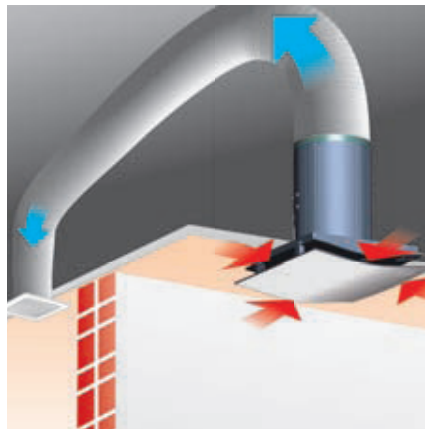
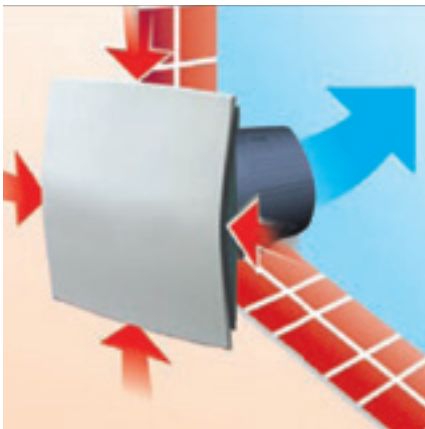









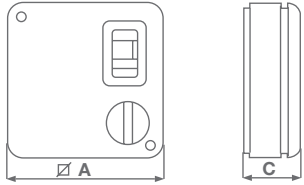

APPLICATIONS

---

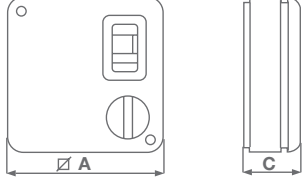

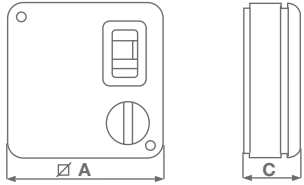

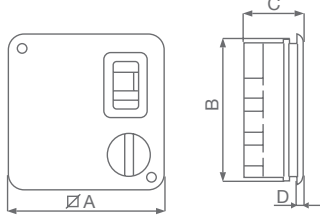

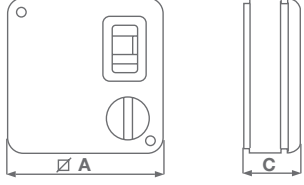



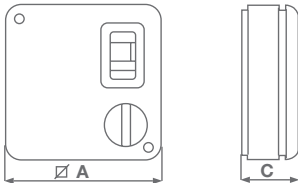

# ACCESSORIES

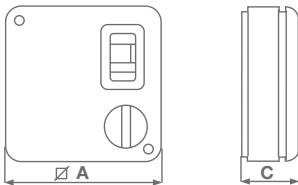
MODELS	DESCRIPTION		CODE											
	<p>C4VM16 - Four-speed selector, single phase</p> <table border="1"> <thead> <tr> <th>MODELS</th> <th>∅ A</th> <th>C</th> </tr> </thead> <tbody> <tr> <td>C4VM16</td> <td>120</td> <td>55</td> </tr> </tbody> </table> <p>Dimensions (mm)</p>		MODELS	∅ A	C	C4VM16	120	55		14021				
	MODELS	∅ A	C											
C4VM16	120	55												
	<p>C3VM3 - Three speed selector, single phase</p> <table border="1"> <thead> <tr> <th>MODELS</th> <th>∅ A</th> <th>C</th> </tr> </thead> <tbody> <tr> <td>C3VM3</td> <td>120</td> <td>43</td> </tr> </tbody> </table> <p>Dimensions (mm)</p>		MODELS	∅ A	C	C3VM3	120	43		12949				
	MODELS	∅ A	C											
C3VM3	120	43												
	<p>C 1.5 Non reversible variable electronic speed controller</p> <ul style="list-style-type: none"> <li>- Not suitable for products with timer or automatic shutters</li> <li>- Convertible to flush-mounted using SCB5 kit</li> <li>- Weight 0.2 Kg</li> <li>- Maximum load: 200 W (for C 1.5)</li> <li>- Double insulation</li> </ul> <table border="1"> <thead> <tr> <th>MODELS</th> <th>∅ A</th> <th>C</th> </tr> </thead> <tbody> <tr> <td>C 1.5</td> <td>120</td> <td>43</td> </tr> </tbody> </table> <p>Dimensions (mm)</p>		MODELS	∅ A	C	C 1.5	120	43		12966				
	MODELS	∅ A	C											
C 1.5	120	43												
	<p>SCNRB Non reversible variable electronic speed controller (built-in)</p> <ul style="list-style-type: none"> <li>- Not suitable for products with timer or automatic shutters</li> <li>- Weight 0.2 Kg</li> <li>- Maximum load: 200 W</li> <li>- Double insulation</li> </ul> <table border="1"> <thead> <tr> <th>MODELS</th> <th>∅ A</th> <th>B</th> <th>C</th> <th>D</th> </tr> </thead> <tbody> <tr> <td>SCNRB</td> <td>142</td> <td>135</td> <td>59.5</td> <td>4.5</td> </tr> </tbody> </table> <p>Dimensions (mm)</p>		MODELS	∅ A	B	C	D	SCNRB	142	135	59.5	4.5		12971
	MODELS	∅ A	B	C	D									
SCNRB	142	135	59.5	4.5										
	<p>C5 0.5 5 position speed controller</p> <ul style="list-style-type: none"> <li>- 5 speeds controller</li> <li>- Not suitable for timer, automatic, automatic timer and cord operated appliances</li> <li>- Convertible to flush-mounted using SCB5 kit</li> <li>- Weight 0.2 Kg</li> <li>- Double insulation Non reversible variable electronic speed controller (built-in)</li> <li>- Not suitable for products with timer or automatic shutters</li> <li>- Weight 0.2 Kg</li> <li>- Maximum load: 200 W</li> <li>- Double insulation</li> </ul> <table border="1"> <thead> <tr> <th>MODELS</th> <th>∅ A</th> <th>C</th> </tr> </thead> <tbody> <tr> <td>C 1.5</td> <td>120</td> <td>43</td> </tr> </tbody> </table> <p>Dimensions (mm)</p>		MODELS	∅ A	C	C 1.5	120	43		12987				
	MODELS	∅ A	C											
C 1.5	120	43												





MODELS	DESCRIPTION	CODE										
	<p>SPEED REGULATOR - Three-speed selector switch</p> <table border="1"> <thead> <tr> <th>MODELS</th> <th>∅ A</th> <th>C</th> </tr> </thead> <tbody> <tr> <td>SR</td> <td>120</td> <td>43</td> </tr> </tbody> </table> <p>Dimensions (mm)</p>	MODELS	∅ A	C	SR	120	43	 <p>22478</p>				
MODELS	∅ A	C										
SR	120	43										
	<p>KIT SCB - Kit to convert C1.5 to built-in model KIT SCB5 - Kit to convert C5 0.5 to built-in model</p> <table border="1"> <thead> <tr> <th>MODELS</th> <th>∅ A</th> <th>B</th> <th>C</th> <th>D</th> </tr> </thead> <tbody> <tr> <td>SCB/SCB5</td> <td>142</td> <td>135</td> <td>59.5</td> <td>4.5</td> </tr> </tbody> </table> <p>Dimensions (mm)</p>	MODELS	∅ A	B	C	D	SCB/SCB5	142	135	59.5	4.5	 <p>22481 22483</p>
MODELS	∅ A	B	C	D								
SCB/SCB5	142	135	59.5	4.5								
MODELS	DESCRIPTION	CODE										
	<p><b>C HCS</b> Checks the relative humidity of the air: the extractor fan is activated automatically when the relative humidity percentage exceeds 65%. Otherwise, the appliance starts automatically a few seconds after the light is switched on and continues to run for a set time after it has been switched off again; this time period can be adjusted to a value between 3 and 20 minutes using a built-in trimmer.</p>	12994										
	<p><b>C TEMP</b> Checks the temperature of the surrounding air: the extractor fan is activated automatically when a certain temperature is recorded; this can be adjusted, using an external trimmer, to a value between 10 °C and 40 °C above the set threshold. A timer keeps it running after the temperature has fallen below the set threshold, for a period of time which can be adjusted to a value between 3 and 20 minutes using a built-in trimmer.</p>	12992										
	<p><b>C SMOKE</b> Checks the quality of the air when the air contains cigarette smoke, odours and other pollutants: the extractor fan is activated automatically when a concentration of odours higher than the set value is detected; this value can be adjusted using an external trimmer. A pre-set timer, which can be adjusted to a value between 3 and 20 minutes using a built-in trimmer, keeps the extractor fan running for the desired period of time.</p>	12993										
	<p><b>C PIR</b> Checks for human motion in the room: the extractor fan is activated automatically for a specified time period, which can be adjusted between 3 and 20 minutes using a trimmer, when human movement is detected in its range.</p>	12998										
	<p><b>WWC TIMER</b> Checks the operating time of the appliance to which it is connected: the extractor fan is activated automatically a few seconds after the light is switched on and continues to run for a set time, which can be adjusted to a value between 3 and 20 minutes using a built-in trimmer, after it has been switched off again.</p>	12999										



## RESIDENTIAL VENTILATION

### ACCESSORIES

#### MODELS

#### DESCRIPTION

#### CODE



KIT TE - Roof cowl/wind baffle kit  
150/6" - 230/9" - 300/12"

MODELS	CODE	∅ A	B	C	∅ D	H
150/6"	13001	215	175	28	300	111
230/9"	13002	294	249	30	400	145
300/12"	13003	390	316	33	534	181

Dimensions (mm)

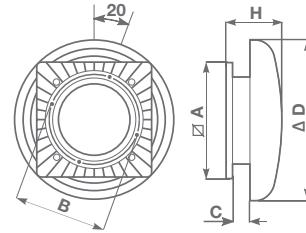

13001  
13002  
13003



KIT SO - Ceiling, false ceiling and panel kit  
150/6"-230/9" - 300/12"

MODELS	CODE	∅ A	B	C
150/6"	13012	215	175	28
230/9"	13014	294	249	30

Dimensions (mm)

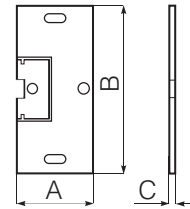

13012  
13014



KIT ML - Deep wall installation kit  
150/6" - 230/9" - 300/12"

MODELS	CODE	∅ A	B	∅ C	D	H
KIT ML150/6"	13015	294	8	171	30	94
KIT ML 230/9"	13016	393	8	240	30	125
KIT ML300/12"	13017	487	8	300	41	142

Dimensions (mm)

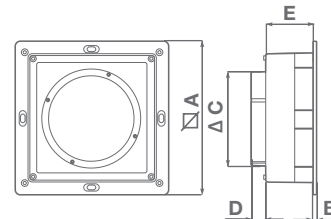

13015  
13016  
13017



KIT MU - Wall mounting kit with rods

MODELS	A	∅ B
KIT MU	380	M4

Dimensions (mm)



13018



KIT VV - Double opening window, secondary glazed kit  
KIT VV 150/6" - KIT VV 230/9" - KIT VV 300/12"





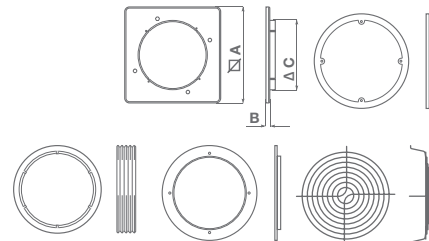

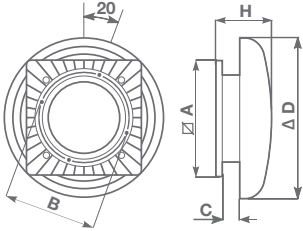

MODELS	CODE	∅ A	B	C
KIT VV 150/6"	13021	215	7	157
KIT VV 230/9"	13022	294	7	233
KIT VV 300/12"	13023	390	7	303

Dimensions (mm)

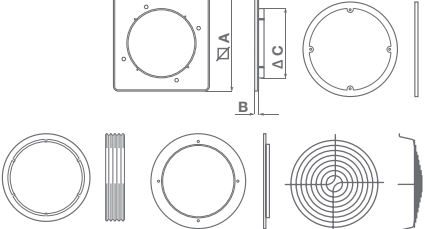

13021  
13022  
13023

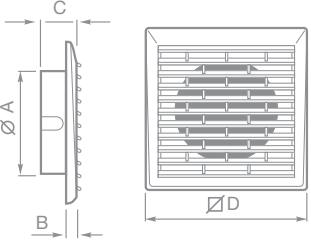

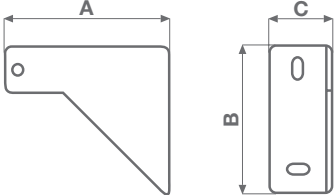
MODELS	DESCRIPTION	CODE																														
	<p>KIT SA 230/9" - Darkroom cowl kit</p> <table border="1"> <thead> <tr> <th><math>\varnothing</math> A</th> <th>B</th> <th>C</th> <th><math>\varnothing</math> D</th> <th>H</th> </tr> </thead> <tbody> <tr> <td>294</td> <td>249</td> <td>30</td> <td>400</td> <td>145</td> </tr> </tbody> </table> <p>Dimensions (mm)</p> 	$\varnothing$ A	B	C	$\varnothing$ D	H	294	249	30	400	145	13004																				
$\varnothing$ A	B	C	$\varnothing$ D	H																												
294	249	30	400	145																												
	<p>KIT FF - Double opening window, secondary glazed kit KIT FF 150/6" - KIT FF 230/9" - KIT FF 300/12"</p> <table border="1"> <thead> <tr> <th>MODELS</th> <th>CODE</th> <th><math>\varnothing</math> A</th> <th>B</th> <th>C</th> </tr> </thead> <tbody> <tr> <td>KIT FF 150/6"</td> <td>13024</td> <td>215</td> <td>7</td> <td>157</td> </tr> <tr> <td>KIT FF 230/9"</td> <td>13025</td> <td>294</td> <td>7</td> <td>233</td> </tr> <tr> <td>KIT FF 300/12"</td> <td>13026</td> <td>390</td> <td>7</td> <td>303</td> </tr> </tbody> </table> <p>Dimensions (mm)</p> 	MODELS	CODE	$\varnothing$ A	B	C	KIT FF 150/6"	13024	215	7	157	KIT FF 230/9"	13025	294	7	233	KIT FF 300/12"	13026	390	7	303	13024 13025 13026										
MODELS	CODE	$\varnothing$ A	B	C																												
KIT FF 150/6"	13024	215	7	157																												
KIT FF 230/9"	13025	294	7	233																												
KIT FF 300/12"	13026	390	7	303																												
	<p>KIT TC - Duct diameter for Spigot Plate</p> <table border="1"> <thead> <tr> <th>MODELS</th> <th>CODE</th> <th><math>\varnothing</math> D</th> </tr> </thead> <tbody> <tr> <td>KIT TC 150/6"</td> <td>13024</td> <td>215</td> </tr> <tr> <td>KIT TC 230/9"</td> <td>13025</td> <td>294</td> </tr> <tr> <td>KIT TC 300/12"</td> <td>13026</td> <td>390</td> </tr> </tbody> </table> <p>Dimensions (mm)</p> 	MODELS	CODE	$\varnothing$ D	KIT TC 150/6"	13024	215	KIT TC 230/9"	13025	294	KIT TC 300/12"	13026	390	13027 13028 13029																		
MODELS	CODE	$\varnothing$ D																														
KIT TC 150/6"	13024	215																														
KIT TC 230/9"	13025	294																														
KIT TC 300/12"	13026	390																														
	<p>KIT MU Wall mounting kit with rods</p> <table border="1"> <thead> <tr> <th>MODELS</th> <th>CODE</th> <th><math>\varnothing</math> A</th> <th>B</th> <th>C</th> <th><math>\varnothing</math> D</th> </tr> </thead> <tbody> <tr> <td>D 100</td> <td>22140</td> <td>99</td> <td>8</td> <td>20</td> <td>140</td> </tr> <tr> <td>D 125</td> <td>22141</td> <td>119</td> <td>8</td> <td>20</td> <td>160</td> </tr> <tr> <td>D 150</td> <td>22142</td> <td>155</td> <td>8</td> <td>20</td> <td>198</td> </tr> <tr> <td>D 90</td> <td>22143</td> <td>92.5</td> <td>8</td> <td>20</td> <td>140</td> </tr> </tbody> </table> <p>Dimensions (mm)</p> 	MODELS	CODE	$\varnothing$ A	B	C	$\varnothing$ D	D 100	22140	99	8	20	140	D 125	22141	119	8	20	160	D 150	22142	155	8	20	198	D 90	22143	92.5	8	20	140	22140 22141 22142 22143
MODELS	CODE	$\varnothing$ A	B	C	$\varnothing$ D																											
D 100	22140	99	8	20	140																											
D 125	22141	119	8	20	160																											
D 150	22142	155	8	20	198																											
D 90	22143	92.5	8	20	140																											
	<p>CA-MU Galvanized sheet-metal brackets For wall or ceiling mounting</p> <table border="1"> <thead> <tr> <th>A</th> <th>B</th> <th>C</th> </tr> </thead> <tbody> <tr> <td>144</td> <td>54</td> <td>55,8</td> </tr> </tbody> </table> <p>Dimensions (mm)</p> 	A	B	C	144	54	55,8	22674																								
A	B	C																														
144	54	55,8																														



## RESIDENTIAL VENTILATION

### ACCESSORIES

#### MODELS

#### DESCRIPTION

#### CODE

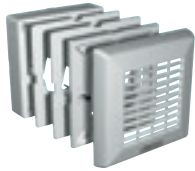

#### KIT TO WINDOW-MOUNT

Will allow any Vortice® Punto unit to be fitted to any single or double glazed window. IPX4; Insulation: Cl.II; Weight Kg. 0.85/1.15/1.56.

MODELS	CODE	∅ A	B	C	∅ HOLE GLASS	THICKNESS MAX
F 100/4"	22131	158	69	22	123÷128	20
F 120/5"	22132	179	80	33	143÷148	20
F 150/6"	22133	213	87	40	178÷183	20

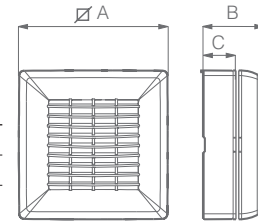

Dimensions (mm)

22131  
22132  
22133

#### RECESSED CEILING INSTALLATION KIT

MODELS	CODE	∅ H
MICRO	22491	268
MEDIO	22492	285
SUPER	22493	330

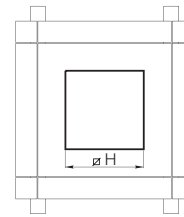

Dimensions (mm)

22491  
22492  
22493



#### RUBBER CEILING KIT

Made of soft rubber to prevent water infiltration and to maintain IPX4 protection on all surfaces.

MODELS	CODE	∅ A	B	C
S 100/4"	22154	166	99	10.5
S 120/5"	22155	187	119	10.5
S 150/6"	22156	222	156	10.5

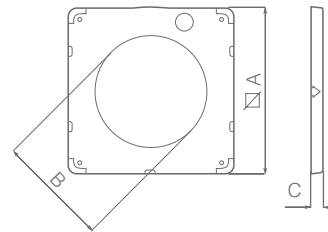

Dimensions (mm)

22154  
22155  
22493



#### LOFT MOUNTING BRACKETS

MODELS	CODE	A	B
D 90/100	22259	22.5	115
D 120	22260	22.5	135
D 150	22261	222	172

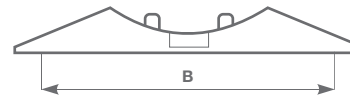

Dimensions (mm)

22259  
22260  
22261



#### TELESCOPIC WALL LINER



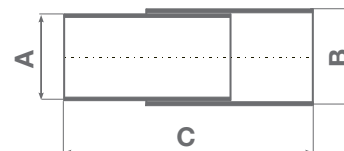





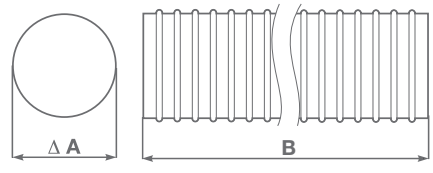

MODELS	CODE	A	B	C
D 100	22253	110	114	200-380
D 120	22254	130	135	200-380
D 150	22258	160	168	200-380

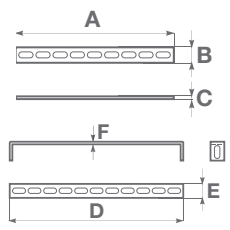

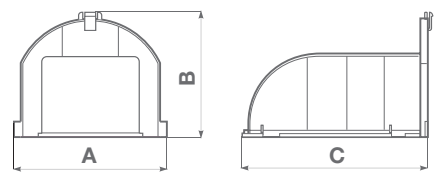
Dimensions (mm)

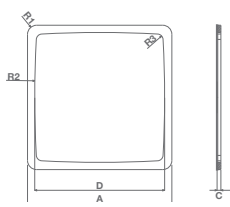
22256  
22257  
22258

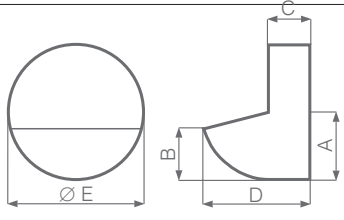

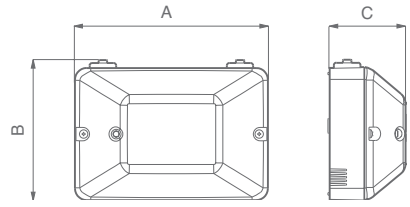
MODELS	DESCRIPTION		CODE							
	<b>FLEXIBLE DUCT</b> Flexible PVC duct (extendable up to 3 m)		22250 22251 22252							
	<b>MODELS</b>	<b>CODE</b>		<b>Ø A</b>	<b>B</b>					
	PVC Ø 100	22250		110	3000					
	PVC Ø 120	22251		130	3000					
	PVC Ø 150	22252		160	3000					
Dimensions (mm)										
	<b>FALSE CEILING KIT</b> Kit for false ceiling installations (max. height 40 cm)		22815 22823							
	<b>MODELS</b>	<b>CODE</b>		<b>A</b>	<b>B</b>	<b>C</b>	<b>D</b>	<b>E</b>	<b>F</b>	
	VP-C	22815		275	20	3	324	20	3	
	Kit false ceiling	22823		275	20	3	226	20	3	
	Dimensions (mm)									
	<b>HORIZONTAL OUTLET SPIGOT</b> For fitting to extractors to direct the outlet horizontally, 105x82 mm, white, plastic for Arietti I		22841							
	<b>MODELS</b>	<b>A</b>		<b>B</b>	<b>C</b>					
	Outlet spigot	105		82	175					
Dimensions (mm)										
	<b>SF CEILING KIT</b>		22162 22163 22164							
	<b>MODELS</b>	<b>CODE</b>		<b>A</b>	<b>B</b>	<b>C</b>	<b>D</b>	<b>R1</b>	<b>R2</b>	<b>R3</b>
	SF Ø 90-100	22162		171	171	5	150.5	7.5	1200	7
	SF Ø 120	22163		190	190	5	171	12	1400	7.5
	SF Ø 150	22164		230	230	5	205.5	13	1700	5
Dimensions (mm)										
	<b>M 10/4 AIR FLOW DEFLECTOR</b> For fitting to the delivery side of extractor fans to direct the air flow in any required direction within 360° Weight kg. 0.2. Design: F. Trabucco - M. Vecchi		22310							
	<b>MODELS</b>	<b>A</b>		<b>B</b>	<b>C</b>	<b>D</b>	<b>E</b>			
	M 10/4	49.5		37	30	77	99			
	Dimensions (mm)									
		<b>GA 12V - Air flow deflector</b> 220-240/12 V ~ 50 Hz; Weight Kg 0.8; Max °C 50; Insulation: Cl.II		22150 22151						
<b>MODELS</b>		<b>CODE</b>	<b>A</b>		<b>B</b>	<b>C</b>				
GA12V		22150	161		117	65				
GA12V T		22823	161		117	65				
Dimensions (mm)										

Vortice Elettrosociali S.p.A  
Strada Cerca, 2  
Frazione di Zoate  
20067 Tribiano (Milano)  
Tel. (+39) 02 906991  
Fax (+39) 02 90699625  
Italia  
[www.vortice.com](http://www.vortice.com)

Vortice Limited  
Beeches House-Eastern  
Avenue Burton on Trent  
DE13 0BB  
Tel. (+44) 1283-49.29.49  
Fax (+44) 1283-54.41.21  
United Kingdom  
[www.vortice.ltd.uk](http://www.vortice.ltd.uk)

Vortice Ventilation System  
(ChangZhou) Co.LTD  
No. 388 West Huanghe Road  
Building 19, ChangXhou  
Post Code: 213000  
China  
Tel. (+86) 0519 88990150  
Fax (+86) 0519 88990151  
[www.vortice-china.com](http://www.vortice-china.com)

Vortice Latam S.A.  
3er Piso, Oficina 9-B  
Edificio Meridiano  
Guachipelín, Escazú  
San José, Costa Rica  
PO Box 10-1251  
Tel. (+506) 2201.6219  
Fax (+506) 2201.6239  
[www.vortice-latam.com](http://www.vortice-latam.com)

